

 **BARRISOL®**

2019  

---

20

L'ESSENTIEL | THE ESSENTIAL | DAS WESENTLICHE

# ATTENTION | WARNING | ACHTUNG



**POUR VOTRE SÉCURITÉ :** Vérifiez avant de commander vos produits que l'installateur est un professionnel agréé **Barrisol®**. Consultez la liste de nos installateurs dans le monde entier sur notre site : **www.barrisol.com** - **Rubrique : localiser un installateur**. N'hésitez pas à nous contacter pour plus d'infos.

**FOR YOUR SAFETY:** Before ordering your products, check that the installer is an authorized by **Barrisol®** professional. You can consult the list of our installers worldwide on our website: **www.barrisol.com** - **Topic: find installer**. Do not hesitate to contact us for more information.

**ZU IHRER SICHERHEIT:** Bevor Sie Ihre Produkte bestellen, überprüfen Sie, ob der Installateur ein autorisierter **Barrisol®** Professional ist. Schauen Sie sich unsere Liste der Installateure in der ganzen Welt auf unserer **Website: www.barrisol.com** - **Sektion: Barrisolverleger in Ihrer Nähe**. Zögern Sie nicht, uns für weitere Informationen zu kontaktieren.



**POUR ACTIVER ET BÉNÉFICIER DE LA GARANTIE BARRISOL® 10 ANS\***, enregistrez votre plafond sur notre site internet : **www.barrisol.com/fr/activer-ma-garantie**

**TO ACTIVATE AND BENEFIT FROM THE 10-YEAR BARRISOL® WARRANTY\***, register your ceiling on our website: **www.barrisol.com/uk/activate-my-warranty**



**PROFITIEREN SIE VON DER 10-JÄHRIGEN BARRISOL® GARANTIE\* UND AKTIVIEREN SIE IHRE DECKE** durch die Registrierung auf unserer Webseite: **www.barrisol.com/de/registrieren-garantie**

\*Garantie Barrisol® 10 ans sur les soudures toiles et soudures harpons  
\*The 10-year Barrisol® warranty on membrane welding seam and harpoon  
\*Der 10-jährigen Barrisol®garantie auf Nähte der Decke und des Keders

Pour lire un QR code, vous devez au préalable télécharger une application « lecteur de QR code » (si vous possédez un iPhone, vous pouvez simplement utiliser l'appareil photo pour « flasher le QR code »). Ouvrez l'application, vous verrez que cela a pour effet d'activer la caméra de votre téléphone. Il vous suffit ensuite de viser le QR code pour lire son contenu :

- Vidéo : Vous renvoie vers les vidéos Youtube de nos projets
- 360° : Vous renvoie vers **www.barrisol360.com** vers les vues en 360° de nos projets
- PDF : Vous renvoie vers nos documentations, présents sur **www.barrisol.com/fr/documentations**

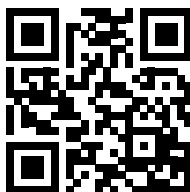

To scan a QR code, you first have to download a QR code-scanner application (if you have an iPhone, just use the camera in Scan Code mode).

Open the application, and you'll see that this activates your telephone's camera. Just point it at the QR code to scan the content:

- Video: takes you to YouTube videos of our projects
- 360°: takes you to **www.barrisol360.com** and 360° vies of our projects
- PDF: Takes you to our documentation, at **www.barrisol.com/fr/documentations** (documentation)

Um den QR-Code lesen zu können, müssen Sie zuerst die App „QR-Code-Reader“ herunterladen (wenn Sie ein iPhone besitzen, können Sie einfach den QR-Code mit der Kamera-Funktion scannen).

Beim Öffnen der Anwendung wird die Kamera Ihres Handys aktiviert. Dann brauchen Sie einfach nur den QR-Code zu scannen, um dessen Inhalt zu lesen:

- Video: Sie werden zu den YouTube-Videos unserer Projekte weitergeleitet.
- 360°: Sie werden zur Website **www.barrisol360.com** für die 360°-Ansicht unserer Projekte weitergeleitet.
- PDF: Sie werden zu unserer Online-Dokumentation auf **www.barrisol.com/fr/documentations** weitergeleitet.





**B**uilding **a**dvanced **r**esearch for **r**eliable and **i**nnovative **s**olutions

**COPYRIGHT © 2009 - 2019 NORMALU S.A.S. - Tous droits réservés.**

La reproduction totale ou partielle de ce document est interdite. Son traitement informatique, sa transmission sous quelque forme que ce soit, par moyen électronique, mécanique, par photocopie, par enregistrement ou autres méthodes sont interdits.

The total or partial reproduction of this document is prohibited, its data-processing treatment, its transmission in any form or by any means, electronic, mechanical, photographic, recording or other methods are prohibited.

Die volle oder teilweise Reproduktion dieses Dokument ist verboten, sein Informationsgehalt, seine Übertragung in irgendeine andere Form, elektronisch, mechanisch durch Photokopie, durch Erfassung oder andere Methoden sind verboten.

# L'ESSENTIEL | THE ESSENTIAL | DAS WICHTIGSTE

Projets d'exception - Exceptional projects - Einzigartige Projekte	4	Barrisol Les Effets Béton® - Concrete effect - Beton Effekt	126
L'Univers Barrisol® - Barrisol® universe - Barrisol® Universum	16	Barrisol Les Effets Bois® - Wood effect - Holz Effekt	128
Certifications/Membre - certifications/membership - Beglaubigung/Mitgliedschaft	22	Barrisol Les Effets Brique® - Brick effect - Backstein Effekt	130
Barrisol® Sécurité & Écologie Safety and ecology - Sicherheit und Ökologie	28	Barrisol Les Effets Marbre® - Marble effect - Marmor Effekt	132
Barrisol Les Recyclés® - The Recycled - Die Recycelten	34	Barrisol Reflet Laqué® - Lacquered Reflection - Die lackierte Lichtreflexion	134
Barrisol Biosourcée® - Biosource - Die Biobasierte	36	Barrisol Les Metals® - Metals - Metall	136
Barrisol Clim®	38	Barrisol Les Daims Ambiance® - Suede - Das Ambiente Wildleder	138
Barrisol Acoustics®	44	Barrisol® Fibres Optiques - Fiber Optics - Glasfaserlösungen	140
Barrisol Gts® Solution textile de verre - Glass textile solution - Glasgewebesystem A2-s1,d0	48	Barrisol Perfodesign®	142
Arcolis®	52	Barrisol Creadesign®	144
Microsorber®	56	Barrisol® Stands & structures événementielles Exhibition stands and event structures system - Messenstände und Events	146
Barrisol Mirror®	60	Artolis® by Barrisol®	148
Barrisol Lumière Acoustique® - Acoustic Light® - Das akustische Licht®	70	Artolis Bi-stretch® by Barrisol®	152
Barrisol Lumière® - Light - Licht	74	Chantal Thomass for Barrisol®	154
Barrisol Light Lines®	78	Keishu Kawai for Barrisol®	156
Barrisol® Bandes lumineuses - Light strips - Lichtstreifen	80	Barrisol® et le Musée de l'Impression Sur Étoffes The Museum of Printed Textiles - Dem Stoffdruckmuseum	158
Barrisol Lumière Color®	82	Barrisol® et le Musée du Papier Peint - Wallpaper Museum - Tapetenmuseum	160
Barrisol® Caissons lumineux - Illuminated light boxes - Lichtkästen	84	Barrisol® et le Musée Hansi	162
Barrisol® Luminaires - Lightings - Leuchtendesign	88	Barrisol® et la Réunion des Musées Nationaux National museums Network - Vereinigung der Nationalmuseen	164
Barrisol® Lovegrove	92	Barrisol Dalrenov®	166
Barrisol® Castiglioni	94	Barrisol® Dalles - Tiles - Platten	167
Barrisol Butterfly Lamp® by Chantal Thomass	96	Barrisol Trempo®	168
Barrisol Luminaire PLUS® by Alix Videlier	98	Barrisol Trempoacoustic® $\alpha_v = 1.0$	170
Barrisol Lampe King® by Pilot Design	100	Barrisol Trempovision®	172
Barrisol® Objets & Design	101	Barrisol IMO	174
Barrisol® Le Fauteuil by Vallon - The armchair by Vallon - Der Lehnssessel by Vallon	102	Barrisol® Santé - Health - Gesundheit	176
Barrisol ELT3D®	104	Projets d'exception - Exceptional projects - Einzigartige Projekte	178
Barrisol® Mural - Mural - Wand	106	Barrisol Mini Star®	238
Barrisol® Modulaire - Modular - Modular	108	Barrisol Star®	240
Barrisol® Colonne 3D - Column 3D - Säule 3D	110	Barrisol Tradition®	242
Barrisol® Cadres & Tubes forme 3D Frames and tubes 3D shape - Rahmen & Röhren in 3D	112	Barrisol® Technique - Technical - Technische	244
Barrisol® Formes 3D - 3D shapes - 3D-Formen	114	Barrisol® profils et éléments techniques - Rails system- Leisten und Profile	248
Barrisol Print your Mind®	118	Barrisol® Couleurs & finitions - Colours & finishes - Farben & Verarbeitungen	276
Barrisol® Projection et Jeux de lumière Projection and lighting effects - Projektion und Lichtspiele	122		
Barrisol Layers Concept®	124		

# Nos solutions Barrisol®

## Our Barrisol® solutions | Unsere Barrisol® Lösungen

### Nos solutions acoustiques

Our acoustic solutions - Unsere akustischen Lösungen

Barrisol Acoustics®	44
Arcolis®	52
Microsorber®	56
Barrisol Lumière Acoustique® - Acoustic Light® - Das akustische Licht®	70

### Nos solutions lumière

Our lightings solutions - Unsere Lösungen mit Licht

Barrisol Lumière® - Light - Licht	74
Barrisol Light Lines®	78
Barrisol® Bandes lumineuses - Light strips - Lichtstreifen	80
Barrisol Lumière Color®	82
Barrisol® Caissons lumineux - Illuminated light boxes - Lichtkästen	84
Barrisol® Luminaires - Lightings - Leuchtdesign	88
Barrisol ELT3D®	104
Barrisol® Projection et Jeux de lumière	
Projection and lighting effects - Projektion und Lichtspiele	122

Nos solutions LEED®, HQE® et BREEAM® -  
Our LEED®, HQE® and BREEAM® solutions  
Unsere LEED®, HQE®- und BREEAM®-Lösungen

Barrisol Les Recyclés® - The Recycled - Die Recycelten	34
Barrisol Biosourcée® - Biosource - Die Biobasierte	36

### Notre solution climatisation

Our climatisation solution - Unsere Lösung für die Klimatisierung

Barrisol Clim®	38
----------------	----

### Nos solutions textiles - Our textile solutions - Unsere textilen Lösungen

Barrisol Gts® Solution textile de verre - Glass textile solution - Glasgewebesystem A2-s1,d0	48
Artolis® by Barrisol®	148
ArtolisBi-stretch® by Barrisol®	152

### Nos solutions pour l'intérieur

Our solutions for interiors - Unsere Lösungen für den Innenbereich

Barrisol Mirror®	60
Barrisol® Objets & Design	101
Barrisol® Le Fauteuil by Vallon - The armchair by Vallon - Der Lehnssessel by Vallon	102
Barrisol® Mural - Mural - Wand	106
Barrisol® Modulaire - Modular - Modular	108
Barrisol® Colonne 3D - Column 3D - Säule 3D	110
Barrisol® Cadres & Tubes forme 3D	
Frames and tubes 3D shape - Rahmen & Röhren in 3D	112
Barrisol® Formes 3D - 3D shapes - 3D-Formen	114
Barrisol Print your Mind®	118
Barrisol Layers Concept®	124

Barrisol Les Effets Béton® - Concrete effect - Beton Effekt	126
Barrisol Les Effets Bois® - Wood effect - Holz Effekt	128
Barrisol Les Effets Brique® - Brick effect - Backstein Effekt	130
Barrisol Les Effets Marbre® - Marble effect - Marmor Effekt	132
Barrisol Perfodesign®	142
Barrisol Creadesign®	144
Barrisol Dalrenov®	166
Barrisol® Dalles - Tiles - Platten	167

Nos solutions par laçage, ressort ou platine  
Our solution by lacing, spring or platinum  
Unsere Lösungen durch Spannen, Federn oder Platinen

Barrisol Trempo®	168
Barrisol Trempoacoustic® $\alpha_w = 1.0$	170

Nos solutions pour l'extérieur - Our solutions for outside  
Unsere Lösungen für den Außenbereich

Barrisol Trempovision®	172
------------------------	-----

### Luminaires de créateurs - Lighting Designers - Leuchten Designer

Barrisol® Lovegrove	92
Barrisol® Castiglioni	94
Barrisol Butterfly Lamp® by Chantal Thomass	96
Barrisol Luminaire PLUS® by Alix Videlier	98
Barrisol Lampe King® by Pilot Design	100

### Nos partenariats exclusifs et d'exceptions

Our exclusive and special partnerships  
Unsere exklusive und außergewöhnliche Partnerschaft

Barrisol® et le Musée de l'Impression Sur Étoffes The Museum of Printed Textiles - Dem Stoffdruckmuseum	158
Barrisol® et le Musée du Papier Peint - Wallpaper Museum - Tapetenmuseum	160
Barrisol® et le Musée Hansi	162
Barrisol® et la Réunion des Musées Nationaux National museums Network - Vereinigung der Nationalmuseen	164

### Nos partenariats uniques -

Our unique partnerships - Unsere einzigartigen Partnerschaften

Chantal Thomass for Barrisol®	154
Keishu Kawai for Barrisol®	156

### Nos solutions classiques

Our classic solutions - Unsere klassischen Lösungen

Barrisol Mini Star®	238
Barrisol Star®	240
Barrisol Tradition®	242

# Barrisol®

## Projets d'Exception

## Exceptional projects

## Einzigartige Projekte

MUSÉE MAXXI - Rome - Italie

2000 m<sup>2</sup> de Barrisol Lumière - 21 527.82 sq ft of Barrisol Light® - 2000 m<sup>2</sup> von Barrisol Licht®



Barrisol® est votre partenaire pour étudier les solutions les plus adaptées à votre projet, des plus simples aux plus audacieux.

Pour en savoir plus et découvrir les autres projets d'exception Barrisol® rendez-vous sur notre site internet.

Barrisol® is your partner to evaluate the most suitable solutions for your project, from the simplest to the most audacious.

To know more about Barrisol® and to discover other Barrisol® exceptional projects, visit our website.

Barrisol® hilft Ihnen dabei die passende Lösung für Ihr Projekt zu finden. Um mehr über unsere einzigartigen Projekte zu finden, besuchen Sie bitte unsere Internetseite.

[www.barrisol.com](http://www.barrisol.com)



Arch. : Zaha Hadid

MUSÉE CASA ENZO FERRARI - Modène - Italie  
3 000 m<sup>2</sup> de Barrisol® - 32 291.73 sq ft of Barrisol® - 3 000 m<sup>2</sup> von Barrisol®



VIDEO  
▶▶▶



Arch. : Jan Kaplicky (Future Systems) et Andrea Morgante (Shiro Studio)



PROJET NEST BY NESTLÉ - Vevey - Suisse

3000 m<sup>2</sup> de Barrisol® 3D - 32.291.73 sq ft of Barrisol® 3D - 3000 m<sup>2</sup> von Barrisol® 3D

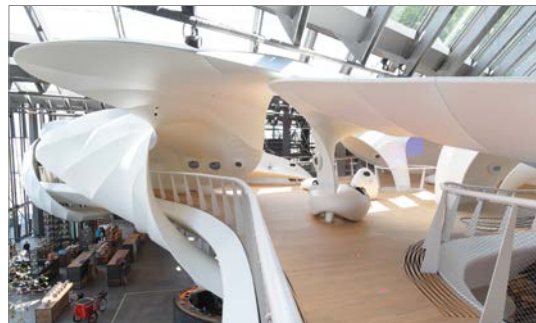

Arch. : Concept Consult Architects Switzerland - Scenography by Tinker

OSLO OPERA HOUSE - Norvège

4.500 m<sup>2</sup> de Barrisol Acoustics® - 48.437.6 sq ft of Barrisol Acoustics® - 4.500 m<sup>2</sup> von Barrisol Acoustics®



Arch. : Snøhetta Architects



ASPIRE - Qatar

16 500 m<sup>2</sup> de Barrisol Acoustics® - 177 604.52 sq ft of Barrisol Acoustics® - 16 500 m<sup>2</sup> von Barrisol Acoustics®



Arch. : CICO and Roger Taillibert





CINELAND OSTIA - Italie

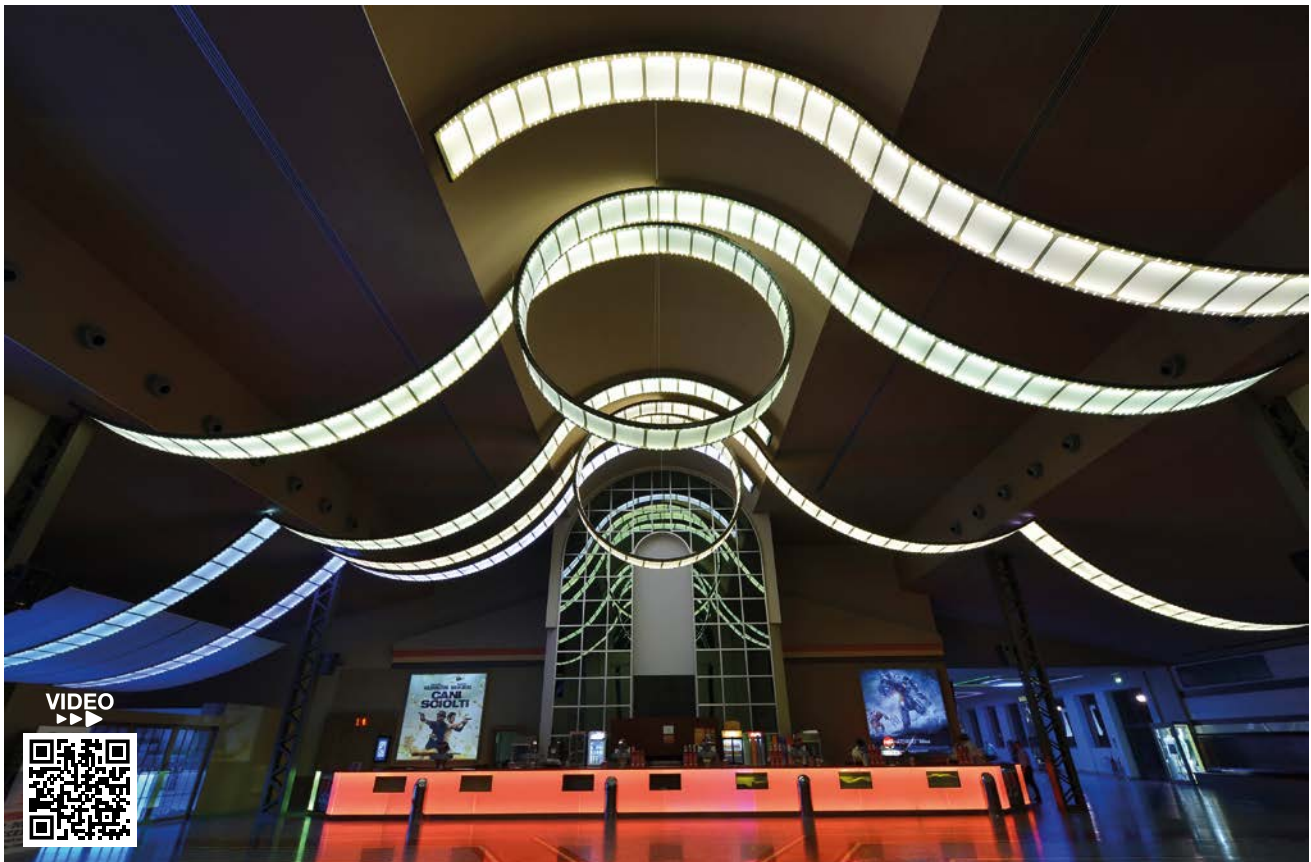

VIDEO



Arch. : Maria Guarrera



MUSÉE ALFA ROMEO - Italie

850 m<sup>2</sup> Barrisol Lumière® - 9 149,32 sq ft Barrisol Light® - 850 m<sup>2</sup> von Barrisol Licht®

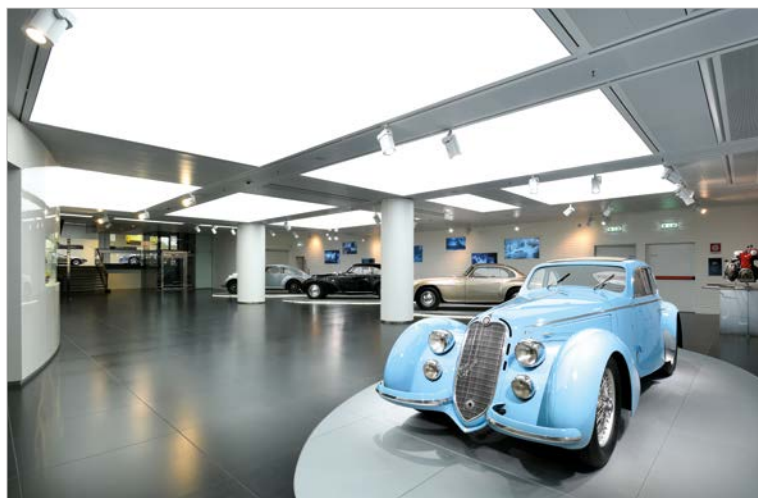

Arch. : Benedetto Camera

AQUATICS CENTER - Londres - Royaume Uni

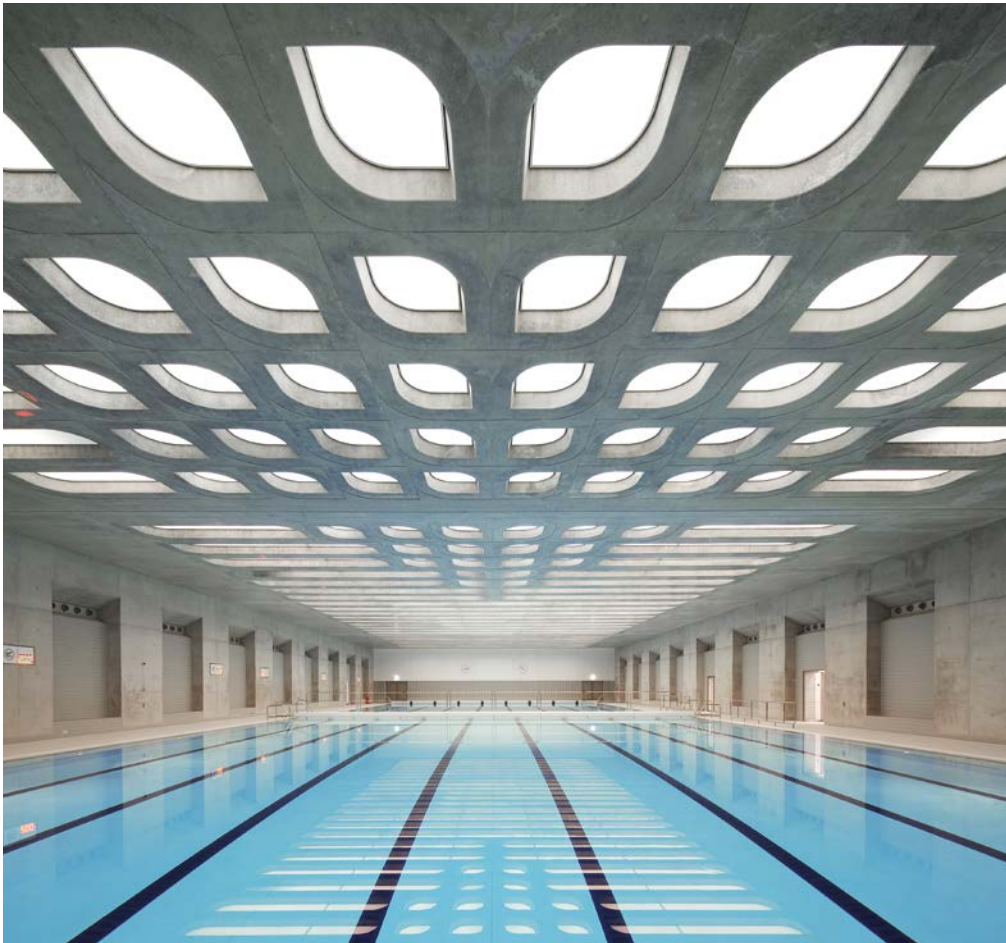

Arch. : Zaha Hadid

VODAFONE ONE NET - République Tchèque



Arch. : Lukáš Křížek, IO STUDIO



PARLY 2 - France

1500 m<sup>2</sup> de Barrisol Acoustics® A30 - 16 145.87 sq ft of Barrisol Acoustics® A30 - 1500 m<sup>2</sup> von Barrisol Acoustics® A30

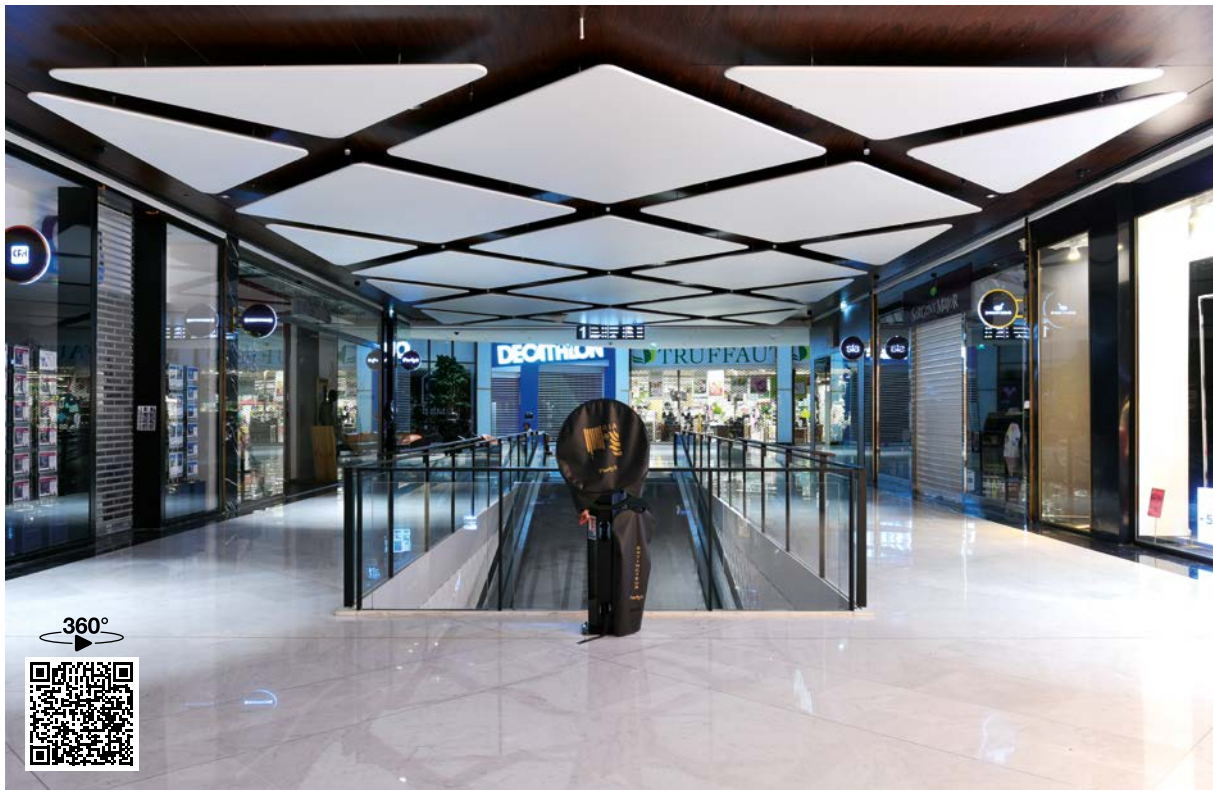

360°



Arch. : Saguez & Partners

Suite des projets d'exceptions page 178

Special projects continued page 178 ■ Fortsetzung der einzigartigen Projekte ab Seite 178

### VICTORIA CENTER - Pologne

3400 m<sup>2</sup> de Barrisol® 3D - 36597.3 sq ft of Barrisol® 3D - 3400 m<sup>2</sup> von Barrisol® 3D



Arch. : Chapman Taylor

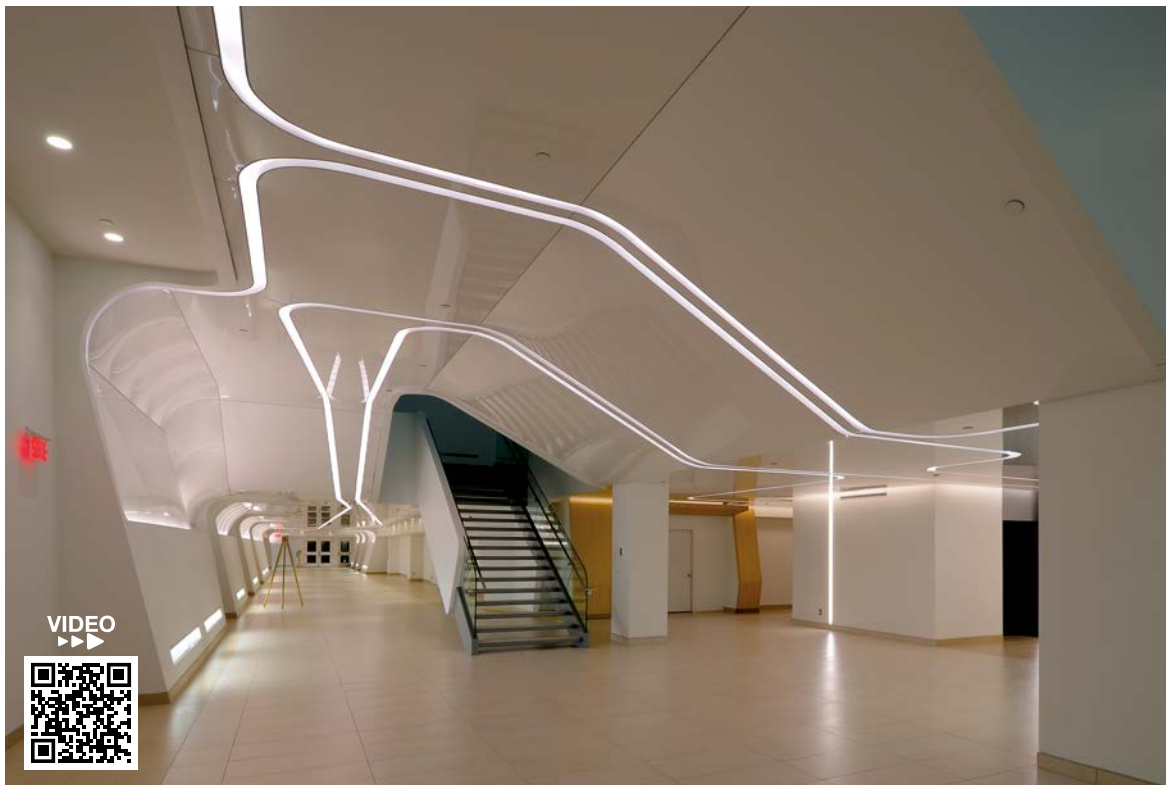

Arch. : Atelier 21

# L'Univers **Barrisol®**

## **Barrisol®** universe ■ **Barrisol®** Universum

Forte de 50 ans d'existence et d'expérience dans le domaine des plafonds tendus, la société Barrisol Normalu® a fait le choix de vendre uniquement des produits sécurisés, garantis sans plomb, ni cadmium. Nos toiles sont classées au feu A ou B avec le meilleur score possible en termes de qualité de l'air intérieur (COV) A+.

With 50 years of experience in stretch ceilings, Barrisol Normalu® has chosen to sell only products that are safe and guaranteed lead- and cadmium-free. Our sheets are Class A or B fire-rated with the best possible score, A+, for interior air quality (VOC).

Auf der Grundlage ihres 50-jährigen Bestehens und ihrer langjährigen Erfahrung im Bereich der Spanndecken hat die Firma Barrisol Normalu® den Entschluss gefasst, nur gesicherte blei- und cadmiumfreie Produkte auf den Markt zu bringen. Unsere Folien entsprechen den Brandschutzklassen A bzw. B und bieten mit A+ die bestmögliche Gesamtnote, was die Luftqualität der Innenräume (VOC) anbelangt.

**Jean-Marc SCHERRER**

Président | President | Präsident Barrisol Normalu® S.A.S





Arch. : CICO and Roger Taillibert

La société Barrisol® Normalu® S.A.S. est depuis plus de 50 ans, le leader mondial dans le domaine du plafond tendu. Elle a reçu plus de 40 récompenses pour saluer sa capacité à innover et à réaliser des produits esthétiques et de qualité. Sa matière noble, son adaptation aux formes les plus audacieuses, la qualité de ses réalisations, en font un matériau idéal et indispensable des créatifs.

« Rendre le monde de demain encore plus beau, c'est d'abord le préserver aujourd'hui ».

Le plafond tendu Barrisol® est recyclable à 100%. La protection et la préservation de l'environnement sont dans notre nature. Toutes ces qualités expliquent le succès mondial de la marque et confortent sa réputation exceptionnelle dans plus de 110 pays.

Les nombreux systèmes de plafonds tendus créés par Barrisol® au cours de ces 50 dernières années forment aujourd'hui un véritable univers : L'UNIVERS BARRISOL®.

Barrisol Normalu® S.A.S. has been the world leader in stretch ceilings for over 50 years. We have received more than 40 awards in recognition of our ability to innovate and make products that are both attractive and high quality. The noble materials, adaptability to the most daring shapes and quality of the workmanship make it the ideal material, indispensable for creative minds.

“To make the world of tomorrow even more beautiful means we first have to preserve it today”.

The Barrisol® stretch ceiling is 100% recyclable. Protecting and preserving the environment comes naturally to us. This explains the worldwide success of the brand and reinforces the exceptional reputation we have in over 110 countries.

All of the many different stretch ceilings systems created by Barrisol® over the course of the last 50 years today form a genuine world: THE WORLD OF BARRISOL®.

Mit einer 50-jährigen Erfahrung ist die Firma Barrisol Normalu® S.A.S zum weltweiten Marktführer für Spanndecken geworden. Sie wurde mit mehr als 40 Preisen oder Medaillen für Innovation oder Qualität ausgezeichnet.

Merkmale, die für uns im Mittelpunkt stehen. Mit qualitativ hochwertigen und einzigartigen Ausführungen wurden die Barrisol® Folien zu einem unverzichtbaren Rohstoff für Künstler und Designer.

„Unsere Welt müssen wir schonen, so dass diese für unsere Kinder noch schöner sein kann“.

Die Barrisol® Spanndecken sind 100% recycelbar. Barrisol Normalu® SAS setzt sich für den Umweltschutz ein. So versteht man besser den weltweiten Erfolg der Firma Barrisol® und ihrem guten Ruf in mehr als 110 Länder. Die verschiedenen Befestigungssysteme wurden von Barrisol® innerhalb der letzten 50 Jahre erfunden und entwickelt. Sie bilden heute das BARRISOL® UNIVERSUM.

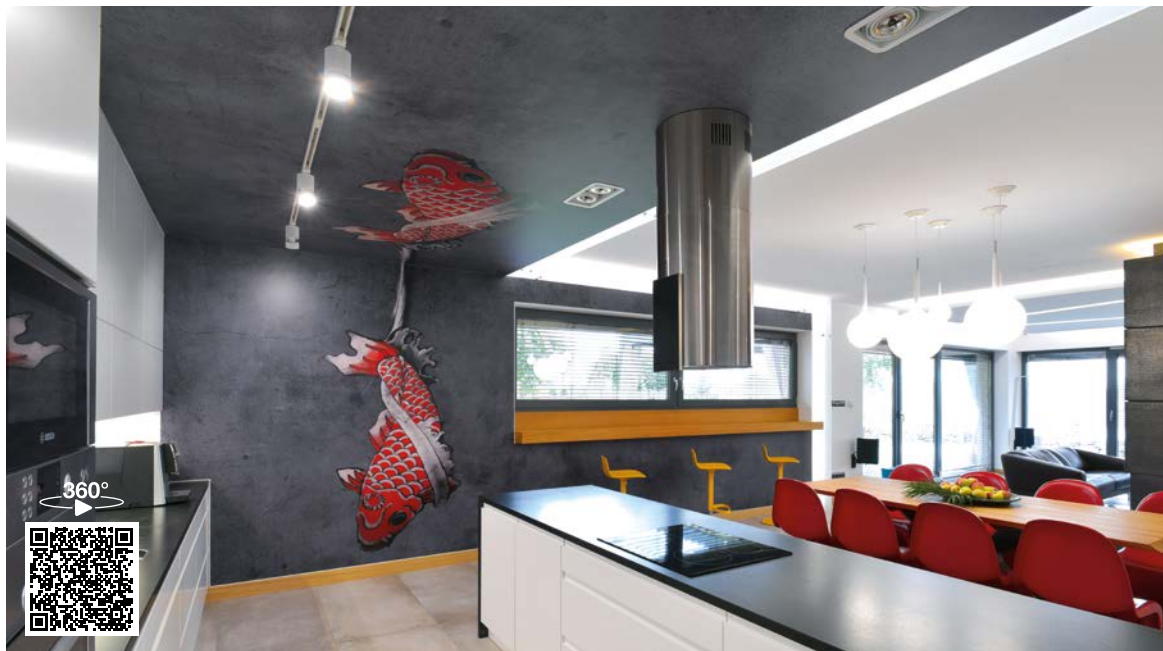

Arch. : Katarzyna Zachariasz-Rybak

## Avantages des murs et des plafonds tendus Barrisol®

Advantages of Barrisol® stretched walls and ceilings | Vorteile von Barrisol® Spannwände und -decken

### Installation

- Installation rapide
- Chantier propre, sans poussière et sans nuisance
- Démontable et remontable à l'identique et à volonté
- Accessibilité aux éléments techniques dans le plénum
- Pas d'émission de substances toxiques volatiles (VOC). Toutes nos gammes sont classés A+ pour votre santé
- Pas de coût d'entretien (à part le nettoyage si nécessaire)
- Faible poids (20 fois moins de matière première en moyenne)
- Garantie 10 ans (soudures toiles et soudures harpon)
- Installation garantie par notre réseau de professionnels agréés Barrisol® pour votre sécurité
- Consultez la liste de nos installateurs agréés dans le monde entier sur notre site : [www.barrisol.com](http://www.barrisol.com)  
Rubrique : localiser un installateur

### Installation

- Quick Installation
- Installed without mess or dust
- Able to be removed and reassembled identically and at will
- Accessibility to technical services behind the ceiling
- No emission of volatile toxic substances (VOC). All our ranges are classified A+ for your health
- No maintenance cost (except cleaning if necessary)
- Lightweight (20 times less raw material than conventional construction systems)
- 10-year warranty (on weld sheet and harpoon)
- Installation guaranteed by our network of authorized Barrisol® professionals for your safety
- You can consult the list of our authorized installers worldwide on our website : [www.barrisol.com](http://www.barrisol.com)  
Topic: find installer

### Installation

- Schnelle Installation
- Sauberer Arbeitsplatz, ohne Staub und Lärm
- Gleiches System für Ein- und Ausbau
- Zugang zu den technischen Elementen hinter der Decke
- Keine Ausdünstung von giftigen Substanzen (VOC). Unser gesamtes Sortiment ist für Ihre Gesundheit A+ zertifiziert
- Keine Kosten für Instandhaltung (Ausnahme wenn eine Reinigung benötigt wird)
- Geringes Gewicht (im Durchschnitt 20 x weniger Rohmaterial)
- 10-Jahre Garantie (auf Schweißnaht und Keder)
- Garantierter Einbau durch unser autorisiertes Barrisol® Netzwerk von Verlegern
- Sie finden unser weltweites Netzwerk von Verlegern auf unserer Homepage : [www.barrisol.com](http://www.barrisol.com)  
Sektion: Barrisolverleger in Ihrer Nähe



Arch. : Chapman Taylor - Designer : Rafal Giersz

## Murs et plafonds tendus acoustiques, lumineux, imprimés, 3D et climatisés

- Nos toiles sont disponibles dans une palette de plus de 230 coloris et 15 finitions
- Plus de 100 systèmes de profilés disponibles, possibilité de créer de profilés sur-mesure
- Nous vous proposons la plus grande gamme de toiles translucides
- La plus large gamme de solutions acoustiques pour les plafonds tendus avec harpon
- Possibilité d'intégrer des systèmes d'éclairage, de chauffage, de climatisation, de vidéo projection et de diffusion du son
- Barrisol® propose une solution pour plafonds lumineux et acoustiques qui permet une luminosité uniforme de LEDs
- Possibilité de faire des perforations design sur-mesure
- Les éléments techniques peuvent être dissimulés derrière le plafond Barrisol®, pour l'esthétique des lieux
- Nettoyables, les toiles Barrisol® n'ont pas besoin de maintenance particulière
- Classement au feu
  - Europe : Bs1-d0, Bs2-d0 et Bs3-d0
  - USA : Class 1
  - Notre produit **Glass Textile** solution : A2-s1,d0, non combustible
- Sans phtalates
- Résiste à l'humidité
- Étanche à l'eau (sauf version perforée), minimise les dégâts des eaux
- Pas de bruit de vibration, idéal pour les projets IMO (bateau)

## Walls and ceilings stretched acoustic, luminous, printed, 3D and climatized

- Our membranes are available in more than 230 colors and 15 finishes
- More than 100 profile systems already available. Profiles can be tailor-made to suit your requirements
- We offer the largest range of translucent membranes
- The widest range of acoustic solutions for stretch ceilings with harpoon
- Lighting, heating, air conditioning, video projection and sound diffusion can all be integrated into our systems
- Barrisol® offers coloured and dimmable LED options for our luminous and acoustic ceilings
- Perforations can be tailor-made
- Technical elements are hidden behind the Barrisol® ceiling, dramatically improving aesthetics
- Barrisol® membranes do not need special maintenance
- Fire classification
  - Europe : Bs1-d0, Bs2-d0 et Bs3-d0
  - USA : Class 1
  - Our **Glass Textile** solution : A2-s1,d0, non-combustible
- Free of phthalate
- Moisture resistant
- Waterproof sheets (all except perforated sheets) minimize water damage
- No vibration noise, ideal for IMO projects (cruiser ships)

## Spannwände und -decken, akustisch, leuchtend, bedruckt, 3D und klimatisierend

- Das Sortiment unserer Folien ist in mehr als 230 Farben und 15 Oberflächen erhältlich
- Über 100 Profilsysteme sind verfügbar, massgeschneiderte Profile können projektspezifisch entwickelt werden
- Wir verfügen über das größte Sortiment transluzenter Folien
- Die breiteste Auswahl von akustischen Lösungen von Spanndecken mit Keder
- Es besteht die Möglichkeit der Integration von Licht, Klimatisierung, Projektion und Lautsprecher
- Barrisol® bietet Lösungen für homogenes Licht und Akustik
- Kundenspezifische Designs für die Perforation sind möglich
- Die technischen Elemente können für die Ästhetik der Decke dahinter verborgen werden
- Reinigung, Barrisol® Folien benötigen keine besondere Pflege
- Brandschutzklassen
  - Europa : Bs1-d0, Bs2-d0 et Bs3-d0
  - USA : Class 1
  - Unser Produkt **Glass Textile** solution : A2-s1,d0, nicht brennbar
- Frei von Phthalaten
- Feuchtigkeitsresistent
- Wasserdicht (Ausnahme perforierte Version) reduziert Wasserschäden
- Kein Vibrationsgeräusch, ideal für IMO Projekte





Design : Simon Norris

## Murs et plafonds tendus acoustiques, lumineux, imprimés, 3D et climatisés (suite)

- Nous vous proposons des solutions personnalisables à l'infini
  - **Solution Barrisol® acoustique**, les performances acoustiques de nos toiles vont de  $\alpha_w = 0,65$  (toile seule sans isolant) jusqu'à  $\alpha_w = 1,0$  (avec un isolant acoustique), et peuvent être lumineuses, imprimées et climatisées
  - **Solution Barrisol® lumière®**, nos toiles translucides peuvent être éclairées ou retro-éclairées avec des sources lumineuses, avec variation de couleur (RVB). Performances acoustiques jusqu'à  $\alpha_w = 0,80$  (Glass Textile solution). Cette solution peut être acoustique, imprimée et climatisée
  - **Solution Barrisol® et Artolis® imprimées**, vous pouvez reproduire tous types de motifs, images ou logos en HD, jusqu'à 5 m sans soudure (textile). Cette solution peut être également lumineuse, acoustique et climatisée (Barrisol Biosourcée®)
  - **Solution Barrisol® 3D**, la conception de volumes aussi légers que fluides en 3 dimensions est possible grâce aux systèmes de profils spécifiques. Cette solution peut être également lumineuse, acoustique, imprimée et climatisée
  - **Solution Barrisol Clim®**, système de climatisation par le plafond, invisible, silencieux et homogène, confort AAA froid et AAA chaud selon la norme ISO 7730. Cette solution peut être également acoustique, lumineuse et imprimée

## Walls and ceilings stretched acoustic, luminous, printed, 3D and climatized (continued)

- We offer customizable solutions to suit any requirements
  - **Barrisol® acoustic solution**, the acoustic performances of our membranes allow for acoustic ratings from  $\alpha_w = 0.65$  (membrane without insulation) up to  $\alpha_w = 1.0$  (with acoustic insulation). They can be backlit, printed and used within our **Clim®** systems
  - **Barrisol Light® solution**, our translucent membranes can be illuminated or backlit, using our backlit systems. This can be white in colour, or can have RGB capabilities. Acoustic performance up to  $\alpha_w = 0.80$  with our **Glass Textile solution**. These can also be acoustic, printed, or used within our **Clim®** systems
  - **Barrisol® and Artolis® printed solutions**, you can reproduce all types of patterns, images or logos in HD, and are seamless up to 5 m (textile). This solution can also be backlit, acoustic and used within our **Clim®** systems (Barrisol® Biosource)
  - **Barrisol® 3D solution**, Barrisol® walls and ceilings are lightweight, and therefore ideal for 3D shapes, using our wide range of profile systems. This can also be backlit, acoustic, printed and used within our **Clim®** systems
  - **Barrisol Clim® solution**, climatization system through the ceiling, invisible, silence and even, comfort AAA cold and hot AAA according to ISO 7730. This solution can also be acoustic, luminous and printed

## Spannwände und -decken, akustisch, leuchtend, bedruckt, 3D und klimatisierend (Fortsetzung)

- Wir bieten kundenspezifische Lösungen
  - **Barrisol® akustische Lösungen**, Die akustischen Werte unserer Folien bewegen sich zwischen  $\alpha_w = 0.65$  ( nur Folie ohne Dämmmaterial ) und  $\alpha_w = 1.0$  ( mit Dämmmaterial ), und können leuchten, bedruckt und klimatisierend sein
  - **Barrisol Licht® Lösungen**, Unsere transluzenten Folien können beleuchtet oder hinterleuchtet werden, weiß oder mit farbigem Licht ( RGB ). Akustische Werte bis = 0,80 ( **Glass Textile solution** ). Die Folien können akustisch wirksam, bedruckt oder in unserem **Clim®** System eingesetzt werden
  - **Barrisol® und Artolis® bedruckt**, Alle Muster, Bilder oder Logos können in HD nachgestellt werden, bis zu 5m ohne Naht (Textil) werden. Diese Lösungen können auch leuchten, akustisch und klimatisierend (Barrisol® Biobasierte) sein
  - **Barrisol® 3D Lösungen**, Dank unserer spezifischen Profile können auch voluminöse 3D Formen leicht und fließend umgesetzt werden. Diese Lösungen können auch leuchten, akustisch und klimatisierend sein
  - **Barrisol Clim® Lösungen**, Klimatisierung durch die Decke, unsichtbar, nahezu nicht hörbar und gleichmäßig, Komfort AAA kalt und warm AAA nach ISO 7730. Diese Lösungen können auch akustisch, leuchten und bedruckt sein



Réalisation : Barrisol®

## La contribution de Barrisol® pour vos projets éco-responsables

Barrisol® contribution for your eco-friendly projects | Der Beitrag von Barrisol® zu Ihren umweltfreundlichen Projekten

**HQE®** **LEED** **BREEAM®**

- Toiles et profilés d'accrochages recyclables à 100%
- Pas d'utilisation d'eau dans nos procédés de fabrication de nos toiles et profilés
- Notre gamme de plafonds Barrisol « les Recyclés® » est fabriquée à 50% avec des toiles Barrisol®, issues de notre filière de recyclage
- Nos profilés sont faits au minimum avec 80% d'aluminium recyclé (post-consommer)
- Grâce à un taux de réflexion de la lumière à 90% la toile spécifique Barrisol® blanche permet de réduire l'utilisation de l'éclairage et est donc une source d'économie énergétique
- Notre gamme de plafonds Barrisol « Biosourcée® » contient dans sa composition jusqu'à 30% d'un plastifiant à base de céréales
- Les trois quarts des déchets produits annuellement en France, sont issus du bâtiment. Avec le système Barrisol® vous utiliserez 20 fois moins de matière première en moyenne en comparaison à un système classique de construction
- Nous sommes très engagés dans l'amélioration du tri sélectif et du recyclage, sur l'usine et sur les chantiers de nos installateurs
- 100% de l'électricité utilisée sur le site de l'usine Barrisol® provient des énergies renouvelables
- Pour réduire la pollution et améliorer la circulation Barrisol® a mis en place un système de navettes pour le transport du personnel afin de protéger l'environnement
- 100% recyclable membranes and profiles
- No water is used during the manufacturing of our membranes or profiles
- Our range Barrisol® "the Recycled" is made with 50% of recycled material from previous Barrisol® installations
- Our profiles are made with at least 80% of recycled aluminum (post-consumer)
- Thanks to a light reflection rate of 90%, the white Barrisol® specific membrane reduces the use of lighting and is therefore a source of energy savings.
- Our range of "Biosource" Barrisol® ceilings contains a plasticizer which is 30% plant-based
- Three-quarters of the waste produced annually in France comes from the construction. With the Barrisol® system you will use 20 times less raw material on average compared to a conventional construction system
- We are very committed to the continued improvement of managing waste and recycling at our factory and construction sites
- 100% of the electricity used at the Barrisol® factory comes from renewable energies
- To reduce pollution and improve car traffic Barrisol® has put in place a shuttle system to transport personnel and to protect the environment
- 100% recycelbare Folien und Profile
- Kein Wasserverbrauch bei der Herstellung unserer Folien und Profile
- Das Sortiment Barrisol® "Die Recycelten" besteht aus 50% recycelter Folien aus unserem Recycling Kreislauf
- Unsere Profile sind mit mindestens 80% recyceltem Aluminium (post-consumer) hergestellt
- Dank der hohen Lichtreflektionsrate von 90% reduziert die spezielle weiße Barrisol® Folie den Verbrauch von Licht und trägt daher zur Energieeinsparung bei
- Unsere Barrisol® Folie "Biobasierte" enthält bis zu 30% Weichmacher auf Getreidebasis
- Drei-Viertel des in Frankreich anfallenden Abfalls stammt aus dem Baugewerbe. Mit dem Barrisol® System benötigt man durchschnittlich bis zu 20 x weniger Rohstoffe als bei herkömmlichen Baumaterialien
- Wir legen sehr großen Wert auf die Trennung der Abfälle und das Recycling sowohl in unsere Produktion als auch bei unseren Verarbeitern
- 100% des Stromverbrauchs in unserer Produktion stammt aus erneuerbaren Energien
- Zur Reduzierung der Abgase und des Straßenverkehrs, hat Barrisol zum Schutz der Umwelt, einen Shuttleservice für unsere Mitarbeiter eingeführt



Label d'excellence du savoir-faire français : **Entreprise du Patrimoine Vivant**  
Label of excellence in French know-how: **“Entreprise du Patrimoine Vivant”**  
Qualitätslabel des französischen Knowhow : „**Entreprise du Patrimoine Vivant**“



Diplôme EPV | EPV Certification | Diplom EPV

En 2015 l'entreprise Barrisol Normalu® s'est vue décerner, par le ministre de l'Économie, de l'industrie et du Numérique, Emmanuel Macron, le label d'excellence « Entreprise du Patrimoine Vivant ».

Ce label tend à promouvoir le développement des entreprises détenant « un patrimoine économique, composé en particulier d'un savoir-faire rare renommé ou ancestral, reposant sur la maîtrise de techniques traditionnelles ou de haute technicité et circonscrit à un territoire.

In 2015, France's Minister of the Economy, Industry and the Digital Economy, Emmanuel Macron, awarded Barrisol Normalu® the Entreprise du Patrimoine Vivant (Living Heritage Company) label of excellence.

This label promotes the development of companies performing “an economic heritage, in particular comprised of rare renowned or ancestral know-how based on the mastery of traditional techniques or that are highly technical and exercised within a specific region.

2015 wurde die Firma Barrisol Normalu® vom französischen Minister für Wirtschaft, Industrie und digitale Wirtschaft, Emmanuel Macron, mit dem Qualitätslabel „Entreprise du Patrimoine Vivant“ ausgezeichnet.

Dieses Qualitätslabel fördert die Entwicklung von Unternehmen, die über ein „wirtschaftliches Erbe“ verfügen, das insbesondere aus einem seltenen, renommierten oder überlieferten Knowhow besteht, basierend auf traditionellen bzw. hochtechnologischen Kompetenzen, beschränkt auf ein geografisches Gebiet.







## Label Origine France Garantie

“Origine France Garantie” (Guaranteed Made in France) label

Label „Origine France Garantie“ (Garantierte Herstellung in Frankreich)



En 2013 l'entreprise Barrisol Normalu® a été labellisée « Origine France Garantie » par l'association Pro France.

### Qu'est-ce que le label « Origine France Garantie » ?

La certification Origine France Garantie a été créée en juin 2010 à la suite de la publication du rapport d'Yves Jégo consacré à la Marque France.

La certification, simple et compréhensible par tous, est le résultat d'une démarche collective d'acteurs qui souhaitent œuvrer ensemble à la promotion du « produire en France » et à la valorisation des savoir-faire industriels et artisanaux.

L'association Pro France qui assure la promotion d'Origine France Garantie est composée de chefs d'entreprise soutenant cette démarche. Son objectif est de :

- Donner une information claire et précise au consommateur sur l'origine française des produits
- Faire connaître les entreprises qui fabriquent en France

Origine France Garantie est l'unique certification qui atteste l'origine française d'un produit. Elle est, transversale (tout secteur confondu) et incontestable (la certification, obligatoire, est réalisée par un organisme certificateur indépendant).

La certification Origine France Garantie assure aux consommateurs la traçabilité du produit en donnant une indication de provenance claire et objective.

In 2013 the company Barrisol Normalu® was labeled “Origine France Garantie” by “Pro France” association.

### What is the “Origine France Garantie” (Guaranteed Made in France) label?

The Origine France Garantie certification was established in June 2010 following publication of a report by Yves Jégo on the Marque France (France Brand).

The certification, which is simple and easily understood, is the result of group work by those wishing to promote the idea of “making in France” and to highlight industrial and craftsman expertise.

The Pro France organisation, which promotes the Origine France Garantie, is comprised of directors of companies that support the initiative. The objective is to:

- Provide the consumer with clear, accurate information about the French origin of products
- Promote companies that manufacture in France

Origine France Garantie is the only certification that attests to the French origin of a product. It is used in all sectors and is indisputable (the compulsory certification is determined by an independent certifying body).

The Origine France Garantie certification ensures consumers that the product is traceable by clearly and objectively stating its origin.

Im Jahr 2013 wurde Barrisol Normalu® vom Verband Pro France mit dem Label „Origine France Garantie“ ausgezeichnet.

### Was ist das Label „Origine France Garantie“?

Die Origine France Garantie-Zertifizierung wurde im Juni 2010 eingeführt, im Anschluss an die Veröffentlichung des Berichts von Yves Jégo über die Marke Frankreich.

Die Zertifizierung, die für alle einfach und verständlich ist, ist das Ergebnis eines kollektiven Ansatzes seitens Akteuren, die gemeinsam an der Förderung des „produire en France“ (in Frankreich produziert) und der Aufwertung des industriellen und handwerklichen Know-how arbeiten möchten.

Der Verein Pro France, der die Origine France Garantie-Zertifizierung fördert, besteht aus Führungskräften, die diese Initiative unterstützen. Sein Ziel ist es:

- dem Verbraucher verständliche und genaue Informationen über die französische Herkunft der Produkte zu geben
- über die Unternehmen zu informieren, die in Frankreich produzieren

Bei der Origine France Garantie-Zertifizierung handelt es sich um die einzige Zertifizierung, die französische Herkunft eines Produkts bestätigt. Sie ist bereichsübergreifend (alle Sektoren zusammengenommen) und unanfechtbar (die obligatorische Zertifizierung wird von einer unabhängigen Zertifizierungsstelle durchgeführt).

Die Origine France Garantie-Zertifizierung garantiert den Verbrauchern die Rückverfolgbarkeit des Produkts durch eine verständliche und objektive Herkunftsangabe.

# Certifications | certifications | Beglaubigung



Toutes les gammes Barrisol® sont étiquetées **A+** (note la plus élevée) conformément à la législation en vigueur sur la qualité de l'air intérieur et l'émission de COV – Composés Organiques Volatiles.

Barrisol® stretched ceiling are **A+ classed** (best result) for indoor air quality, respecting the effective legislation.

Alle Barrisol palette haben mit der **A+ Note** gesamte Barrisol-Produktpalette hat mit der Note A+ die beste Bewertung nach der aktuellen Gesetzgebung für die Luftbeschaffenheit in Innenräumen.



Barrisol® Normalu® SAS, par la haute qualité de ses produits, a obtenu la certification IMO qui atteste la possibilité de poser du plafond tendu Barrisol® sur les navires. **Toutes les toiles tendues Barrisol® répondent aux critères de la résolution A.651 de l'Organisation Maritime Internationale.**

Barrisol® Normalu® SAS obtained the certification IMO which attests the possibility of installing Barrisol® on the ships. **All the Barrisol® sheets meet the criteria of the A.651 resolution of International Maritime Organization.**

Alle unsere Decken erfüllen die Voraussetzungen der Norm A.651, so wurde Barrisol® Normalu® SAS von der IMO zertifiziert. Schiffe und Boote können jetzt mit Barrisol® Decken ausgestattet werden.



Décernée par l'association Pro France, le label **Origine France Garantie** désigne les produits de la gamme Barrisol® comme les premiers plafonds tendus entièrement produits en France.

Awarded by the Association Pro France, the label "Origine France Garantie" is qualifying the products from the Barrisol® range as the first stretch ceilings entirely produced in France.

Die Zertifizierung „Origine France“, ausgestellt von der Vereinigung Pro France, bestätigt dass Barrisol®-Produkte komplett in Frankreich hergestellt werden.



Le label EPV (Entreprise du Patrimoine Vivant) est un label de l'État qui distingue des entreprises françaises aux savoir-faire artisanaux et industriels d'excellence.

The Entreprise du Patrimoine Vivant (EPV) label is a mark of recognition of the French State, put in place to reward French firms for the excellence of their traditional and industrial know-how.

Das Label Entreprise du Patrimoine Vivant (EPV) ist eine Marke, die Frankreich entwickelt hat, um die französischen Unternehmen mit besonderem handwerklichen und industriellen Wissen auszuzeichnen.

[www.patrimoine-vivant.com](http://www.patrimoine-vivant.com)



CERTIFIÉ PAR UN LABORATOIRE INDÉPENDANT  
CERTIFIED BY AN INDEPENDENT LABORATORY  
VON EINEM UNABHÄNGIGEN LABOR BESTÄTIGT  
(LNE)

Pour vous accompagner avec toujours plus de sécurité, **Barrisol® est certifié CE**. Ce marquage atteste la conformité de l'ensemble de nos produits face aux exigences européennes dans le secteur de la construction.

Barrisol® is certified CE. The CE marking, "Conformité Européenne", indicates conformity with the essential health and safety requirements of various, applicable European directives.

Barrisol® ist CE zertifiziert, um die Sicherheit unserer Kunden zu gewährleisten. Dieses Kennzeichen bestätigt, dass alle unsere Produkte die europäischen Voraussetzungen der Bauindustrie erfüllen.



Barrisol® est certifié UL. Cette norme de sécurité sert de référence sur l'évaluation des produits destinés aux marchés américains et canadiens.

Barrisol® is UL certified. This safety standard is a reference to evaluate products intended for American and Canadian markets.

Barrisol® ist UL bescheinigt. Diese Sicherheitsnorm ist der Ausgangspunkt für Produkte, die in den Vereinigten Staaten oder Kanada vermarktet werden.

## Membre | membership | Mitgliedschaft



L'U.S.G.B.C., « US Green Building Council » ou conseil US pour les bâtiments verts.

The U.S. Green Building Council.

U.S.G.B.C. « US Green Building Council » **garantit die nachhaltige Entwicklung von Produkten in der Bauindustrie.**  
[www.usgbc.org](http://www.usgbc.org)



L'U.K.G.B.C., **Conseil du Bâtiment Durable du Royaume-Uni.**

U.K.G.B.C. United Kingdom Green Building Council.

U.K.G.B.C. **UK Green Building Council** sorgt für Kooperationen im Bereich Bauhauptgewebe in Großbritannien.  
[www.ukgbc.org](http://www.ukgbc.org)



Le C.G.B.C., **Conseil du Bâtiment Durable du Canada**

The C.G.B.C., Canada Green Building Council -

C.G.B.C. Canada Green Building Council **fördert den Bau und Entwurf von ökologischen Gebäuden in Kanada.**  
[www.cagbc.org](http://www.cagbc.org)



L'union des fabricants UNIFAB, Association Française de Lutte Anti-contrefaçon, constitue un observatoire unique sur la protection des droits de propriété intellectuelle.

The union of the manufacturers UNIFAB, French Association of Fighting Counterfeits, constitutes a unique observatory on the protection of the intellectual property laws.

**Herstellerverband UNIFAB**, eine französische Vereinigung, die sich gegen Produktfälschung engagiert und heutzutage das einzige Überwachungszentrum ist, das sich mit dem geistigen Eigentum beschäftigt.  
[www.unifab.com](http://www.unifab.com)



Le FIS, Finishes & Interiors Sector (**fabrication, l'approvisionnement, solutions d'aménagement ou de rénovation intérieure**).

The Finishes & Interiors Sector (FIS) represents companies involved in the manufacture, supply and installation of all aspects of interior fit-outs and refurbishments.

FIS, Finishes & Interiors Sector, **vertritt die Unternehmen, die bei der Planung und Durchführung von Lösungen von Inneneinrichtungen oder Renovierungen hinzugezogen werden. FIS steht für herausragend gute Qualität ihrer Mitgliedsbetriebe.**  
[www.thefis.org](http://www.thefis.org)



L'i.e.p.t. rassemble des professionnels du plafond tendu de 44 pays d'Europe, désireux de promouvoir la qualité des matériaux, l'usage de matériaux recyclables et des toiles recyclées.

The i.e.p.t. gathers professionals of the stretch ceiling from 44 European countries in order to promote the quality of materials, the use of recycled sheet and recycled materials.

i.e.p.t. umfasst Fachleute aus 44 Ländern Europas, im Bereich der Spanndecken tätig sind, die Produktqualität und Verwendung von wiederverwertbaren Folien und Rohstoffen fördern.  
[www.iept.eu](http://www.iept.eu)



# Barrisol® dans le monde

## worldwide presence - Vertriebsnetz



Barrisol® est proche de ses prescripteurs et de ses chantiers grâce à son réseau de 1 200 installateurs agréés Barrisol®. Ces entreprises, sont situées dans plus de 110 pays : en France, dans les pays de l'Union Européenne et sur les 7 continents.

Barrisol® is always close to clients and projects thanks to it's network of 1 200 approved Barrisol® installers. These companies, partners of Barrisol®, are located in more than 110 countries - in France, Europe and on the 7 continents.

Für die Auftraggeber und Baustellen von Barrisol® ist ein Netz von 1 200 zugelassenen Barrisol®-Installateuren vorhanden. Diese Partnerunternehmen von Barrisol® befinden sich in über 110 Ländern: in Frankreich, in den Ländern der Europäischen Union und auf den 7 Kontinenten.

Afghanistan	Brazil - Brésilien	Ghana - Ghana - Ghana	Latvia - Lettland	Uzbekistan - Usbekistan	Sri Lanka - Sri Lanka
Afghanistan - Afghanistan	Bulgarie	Grèce	Liban - Libanon - Libanon	Pakistan	Suède
Afrique du Sud	Bulgarie - Bulgarien	Greece - Griechenland	Libye - Libya - Libyen	Pakistan - Paskistan	Sweden - Schweden
South Africa - Südafrika	Burundi	Guatemala	Liechtenstein	Panama	Suisse
Albanie	Burundi - Burundi	Guatemala - Guatemala	Liechtenstein - Liechtenstein	Panama - Panama	Switzerland - Schweiz
Albany - Albanien	Canada	Hong Kong	Lituanie - Lithuania - Litauen	Paraguay	Switzerland - Schweiz
Allemagne	Canada - Kanada	Hong kong - Hongkong	Luxembourg	Paraguay - Paraguay	Sultanat d'Oman
Germany - Deutschland	Chili - Chile - Chile	Hongrie	Luxembourg - Luxemburg	Pays-Bas	Sultanate of Oman
Andorre	Chine - China - China	Hungary - Ungarn	Macao - Macau - Macao	Netherlands - Niederlande	Sultanat Oman
Andorra - Andorra	Chypre - Cyprus - Zypern	Ile Maurice	Macedoine	Pérou - Peru - Peru	Swaziland
Angola - Angola - Angola	Colombie	Mauritius - Mauritius	Macedonia - Mazedonien	Philippines	Swaziland - Swasiland
Angola - Angola - Angola	Colombia - Kolumbien	Inde - India - Indien	Madagascar	Philippines - Philippinen	Tadjikistan
Arabie Saoudite	Corée du Sud	Indonésie	Madagascar - Madagaskar	Pologne - Poland - Polen	Tajikistan - Tadschikistan
Saudi Arabia - Saudi-Arabien	South Korea - Südkorea	Indonesia - Indonesien	Malaisie	Portugal	Taiwan - Taiwan - Taiwan
Argentine	Costa Rica	Irak - Iraq - Irak	Malaysia - Malaysia	Portugal - Portugal	Tanzanie
Argentina - Argentinien	Croatie - Croatia - Kroatien	Irlande	Malawi	Qatar - Qatar - Katar	Tanzania - Tanzania
Arménie	Danemark	Ireland - Irland	Malawi - Malawi	République démocratique du Congo	Tansania - Tanzania
Armenia - Armenien	Denmark - Dänemark	Islande	Maldives	Democratic Republic of the Congo	Thailand
Australie	République dominicaine	Iceland - Island	Maldives - Malediven	Demokratische Republik Kongo	Thailand - Thailand
Australie - Australien	Dominican Republic	Israël - Israel - Israel	Malte - Malta - Malta	République tchèque	Tunisie
Autriche	Dominikanische Republik	Italie - Italy - Italien	Maroc	Czech Republic	Tunisia - Tunesien
Austria - Österreich	Égypte - Egypt - Ägypten	Jamaïque	Morocco - Marokko	Tschechische Republik	Turkmenistan
Azerbaïdjan	Émirats arabes unis	Jamaica - Jamaika	Mexico - Mexiko	Roumanie	Turkmenistan - Turkmenistan
Azerbaijan - Aserbaïdschan	United Arab Emirates	Japon - Japan - Japan	Mexico - Mexiko	Romania - Rumänien	Turquie - Turkey - Türkei
Bahamas	Vereinigtes Arabische Emirate	Jordanie	Moldavie	Royaume-Uni	Ukraine - Ukraine - Ukraine
Bahamas - Bahamas	Équateur	Jordan - Jordanien	Moldavia - Moldavien	United Kingdom	Uruguay
Bahrein	Équateur - Äquator	Kazakhstan	Monténégro	Großbritannien	Uruguay - Uruguay
Bahrein - Bahrein	Espagne	Kazakhstan - Kasachstan	Montenegro - Montenegro	Russie	Venezuela
Belgique	Spain - Spanien	Kenya - Kenya - Kenia	Mozambique	Russia - Russland	Venezuela - Venezuela
Belgium - Belgien	Estonie	Kirghizstan	Mozambique - Mozambik	Sénégal	Vietnam
Bénin - Benin - Benin	Estonia - Estland	Kyrgyzstan - Kirgisien	Namibie	Senegal - Senegal	Vietnam - Vietnam
Biélorussie	États-Unis	Kosovo - Kosovo - Kosovo	Namibia - Namibia	Serbie	Zambie - Zambia - Zambia
Belarus - Weißrussland	United States	Koweït	Nigeria - Nigeria - Nigeria	Serbia - Serbien	Zimbabwe
Bolivie	Vereinigten Staaten	Kuwait - Kuwait	Norvège	Singapour	Zimbabwe - Simbabwe
Bolivia - Bolivien	France	Les îles sous le vent	Norway - Norwegen	Singapore - Singapur	...
Bosnie Herzégovine	France - Frankreich	Windward Islands	Nouvelle-Zélande	Slovaquie	
Bosnia Herzegovina	Finlande	Inseln über dem Winde	New Zeland - Neuseeland	Slovakia - Slowakei	
Bosnien Herzégovina	Finland - Finnland	Lesotho	Ouganda	Slovénie	
Bostwana	Géorgie	Lesotho - Lesotho	Uganda - Uganda	Slovenia - Slowenien	
Bostwana - Botswana	Georgia - Georgien	Lettonie	Ouzbékistan		
Brésil					

# Le Groupe **BARRISOL**® **NORMALU**® **S.A.S**

Président / President / Präsident : **Jean-Marc SCHERRER**

Date de création/ Founded in / Gründungsjahr : 1967

Siège Social / Head Office / Hauptsitz : Route du Sipes - 68680 Kembs - France

Statut juridique / Legal status / Rechtsform : S.A.S.

Effectif/ Staff / Mitarbeiter : 130 - Installateurs / Installers / Installateure : 1200

Chiffre d'affaires / Turnover / Umsatz **Barrisol**® **Normalu**® **SAS** : ≈ 27 millions \$

(dont 65% à l'export - Including 65% via export - Dabei 65% Exportabteilung)

## Les Activités - Activities - Tätigkeitsbereiche

### **BARRISOL**® :

Solutions plafonds et murs tendus - Stretched ceilings and walls solutions -

Spanndecken und Wandbespannungen

Lumière et luminaires - Light and lighting - Licht und Leuchte

Formes 3D et stands - 3D forms and stands - Form 3D und Stand

Solutions acoustiques - Acoustic solutions - Akustisch Lösungen

Solutions imprimées - Printed solution - Bedruckt Lösungen

Microsorber® - Microsorber® - Microsorber®

Arcolis® - Arcolis® - Arcolis®

Cadres acoustiques - Acoustic Frames - Akustikmodule

Artolis® - Artolis® - Artolis®

Solutions textiles intérieurs - Textile indoor - Textile Innenbereich

ELT3D® - ELT3D® - ELT3D®

Solutions Mirror - Mirror solution - Mirror Lösungen (3D, acoustic, luminaire, imprimé)

**Clim**® : Climatisation

**GTs**® : Textile de verre

**Light Lines**® : Solutions pour lignes lumineuses

[www.barrisol.com](http://www.barrisol.com)

**SYMA SYSTEM**® : Fabricant de stands d'exposition, structures événementielles et vitrines de musées.

Manufacturer of stands, event structures and museums showcases

Hersteller von Messestandsysteme und Museumschaukasten

[www.syma.com](http://www.syma.com)

## Sites de Production et de Commercialisation

### Production sites - Fertigungs- und Verkaufsstätte

#### • Site de production : 13500 m<sup>2</sup>

**Kembs (68)** : 9 500 m<sup>2</sup> - Siège / Head Office / Hauptsitz

Usine, bureaux. Fabrication du Barrisol® de 4 000 m<sup>2</sup>

et atelier de transformation Aluminium

Syma® de 5 500 m<sup>2</sup>.

Head office, Manufacture, training center. Fabrication of Barrisol®

and Syma® Aluminium workshop

Werk, Büro, Ausbildungszentrum. Herstellung von Barrisol® Folien

und Syma® Aluminium Werk

**Colmar (68)** : 4 000 m<sup>2</sup> - Stands et Menuiserie / Stands and Furnitures /

Messebau und Schreinerei

#### • Bureaux - Showrooms et centre de formation : 2700 m<sup>2</sup>

**Kembs (68)** : 1 080 m<sup>2</sup>

**Colmar (68)** : 240 m<sup>2</sup>

**Mulhouse (68)** : 240 m<sup>2</sup>

**Mulhouse (68)** : 1 000 m<sup>2</sup>

**Saint-Louis (68)** : 140 m<sup>2</sup>



# BARRISOL®

12 révolutions  
revolutions  
Revolutionen

50 ans  
years  
Jahre

100 brevets  
patents  
Patente



Arch. : Jilenaal Architecture

1<sup>re</sup>/st REVOLUTION

Barrisol®



Design : Barrisol® Finland

2<sup>e</sup>/nd REVOLUTION

Barrisol® Laqué/Lacquer



Arch. : Aedas Architects

3<sup>e</sup>/rd REVOLUTION

Barrisol Star®



Arch. : Marek Deyl & Jan Šesták

4<sup>e</sup>/th REVOLUTION

Barrisol® 3D

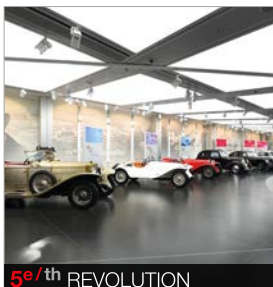

Arch. : Benedetto Camerana

5<sup>e</sup>/th REVOLUTION

Barrisol Lumière®/Light®



Design : Simon Norris

6<sup>e</sup>/th REVOLUTION

Barrisol Print your mind®



Arch. : Lab Architecture & Bétes Smart

7<sup>e</sup>/th REVOLUTION

Barrisol Acoustics®



Arch. : Pulse group of London UK

8<sup>e</sup>/th REVOLUTION

Barrisol Lumière®/Light®  
cadres & 3D / frames & 3D



Designer : Boyurou Mimarlık

9<sup>e</sup>/th REVOLUTION

Barrisol® Miroir/Mirror  
acoustique & lumineuse / acoustic & light



Arch. : Burtiffiek

10<sup>e</sup>/th REVOLUTION

Barrisol Lumière Acoustique®  
Acoustic Light®



Designer : Poes Lovegrove

11<sup>e</sup>/th REVOLUTION

Barrisol® Tubes 3D



Arch. : Jean-François Brodbeck - AMIFS Architectes

12<sup>e</sup>/th REVOLUTION

Barrisol® Climatisation invisible  
froid/chaud - acoustique & lumineuse  
cooling/heating - acoustic & luminous

World n°1 Mondial

[www.barrisol.com](http://www.barrisol.com)



## Barrisol® leader mondial du plafond tendu garantit votre sécurité

World leader of stretched ceiling guarantees your safety

Weltweit Nr. 1 im Bereich Spanndecken garantiert Sicherheit

Barrisol® place la sécurité et la qualité au cœur de son activité depuis toujours, dans le respect des normes et législations en vigueur.

Barrisol® puts the safety and quality in the heart of its activity, conforming to effective legislations.

Barrisol® gibt ihnen Sicherheit und Qualität unter Beachtung der gültigen Normen und gesetzlichen Vorschriften.

Barrisol® garantit une installation saine pour votre santé

Barrisol® guarantees a healthy installation for your health

Barrisol® garantiert eine gesunde Installation für Ihre Gesundheit

Les toiles Barrisol® sont installées à chaud, à une température de 50°. Aucune émission de VCM (Chlorure de Vinyl Monomère) n'est détectée lors de l'opération de chauffe du plafond ou dans les conditions de sa mise en œuvre et après installation.

**Les études confirment que la pose de plafonds tendus à chaud Barrisol® ne présente aucun risque ni pour les poseurs, ni pour le client final.**

The Barrisol sheets are installed, with a temperature of 50°. No emission of VCM (vinyl chloride monomer) has been detected during the warming of the sheet, the installation of the ceiling or after installation.

**The studies confirm that installation of the Barrisol® stretch ceilings presents no danger either for installers, or for final consumer.**

Die Barrisol® Folien werden mit einer Wärme von 50° montiert. Während des Erwärmens und auch während der Montage entstehen keine Emissionen von VCM (Vinylchlorid).

**Die Studien bestätigen, dass durch die Verlegung der Barrisol-Spanndecken mit Wärme keine Risiken für die Verleger und dem Endverbraucher entstehen.**

Barrisol® garantit une économie énergétique

Barrisol® guarantees energy savings

Barrisol® garantit Energieeinsparungen

Grâce à un taux de réflexion de la lumière de 90%, la gamme Barrisol®, notamment le Barrisol Biosourcée® blanc, permet de réduire l'utilisation de l'éclairage et est donc une source d'économie énergétique.

Thanks to a 90% light reflection rate, the Barrisol® range, in particular Barrisol Biosourcée® white, reduces the use of lighting and is therefore a source of energy savings.

Dank einer Lichtreflexion von 90% reduziert die Barrisol®-Produktreihe, insbesondere Barrisol Biosourcée® weiß, den Einsatz von Beleuchtung und spart somit Energie.

Barrisol® vous garantit un produit de haute qualité

Barrisol® guarantees a high quality product

Barrisol® ist ein garantiert hochwertiges Produkt

Les toiles Barrisol® sont 100% conformes à la norme CE, fabriquées avec des plastifiants sans phtalate, garanties sans cadmium, sans mercure, sans plomb et sans arsenic.

Les toiles Barrisol® sont certifiées CE et classées au feu selon les normes européennes et internationales (BS1-d0, BS2-d0, BS3-d0). Barrisol® garantit la sécurité dans les lieux ouverts au public et vous garantit le même niveau d'exigence dans votre maison.

The Barrisol® sheets conform 100% to "CE" legislation, are produced with plasticisers without phtalate and are guaranteed to be without cadmium, without mercury, without lead and without arsenic.

The Barrisol® sheets are "CE" certified and fire rated following the european and international norms (BS1-d0, BS2-d0, BS3-d0). Barrisol® guarantees the safety in public spaces and guarantees the same level of exigency in your house.

Die Barrisol®-Folien entsprechen 100% den CE-Normen der Europäischen Gemeinschaft und werden mit Weichmachern ohne Phthalate hergestellt. Sie sind frei von Cadmium, Quecksilber, Blei und Arsen.

Die Barrisol®-Folien sind CE-zertifiziert und haben die europäische sowie die internationale Brandschutzklassen (BS1-d0, BS2-d0, BS3-d0). Barrisol® garantiert die Sicherheit in öffentlichen und privaten Bereichen.



CERTIFIÉ PAR UN LABORATOIRE INDÉPENDANT  
CERTIFIED BY AN INDEPENDENT LABORATORY  
VON EINEM UNABHÄNGIGEN LABOR BESTÄTIGT  
(LNE)

**Barrisol® et la qualité de l'air | Barrisol® and Indoor air quality****Barrisol® und Luftbeschaffenheit****Toutes les gammes Barrisol® sont étiquetées A+**

(note la plus élevée) conformément à la législation en vigueur sur la qualité de l'air intérieur. Souvent l'air est plus pollué à l'intérieur qu'à l'extérieur, Barrisol® vous garantit un air plus sain et sans risque pour votre santé.

**All the Barrisol® lines are A+ classed**

(best result) for indoor air quality, respecting the effective legislation. Often the air is more polluted inside than outside, Barrisol® guarantees you a healthier air and without risk for your health.

**Die Barrisol® Palette hat mit der A+ Note**

die beste Bewertung nach der aktuellen Gesetzgebung für die Luftbeschaffenheit in Innenräumen. Oft ist die Luft innen stärker verschmutzt als draußen, Barrisol® garantiert Ihnen eine gesündere Luft ohne Risiko für Ihre Gesundheit.



\*Information sur le niveau d'émission de substances volatiles dans l'air intérieur, présentant un risque de toxicité par inhalation, sur une échelle de classe allant de A+ (très faibles émissions) à C (fortes émissions)

**INDOOR AIR EMISSIONS** : Information on the emission level of volatile substances indoors, based on the risk of toxicity due to inhalation, on a scale ranging from Class A (very low emissions) to C (high emissions)

**RAUMLUFTQUALITÄT** : Informationen über das Emissionsniveau von flüchtigen Substanzen in der Luft von Innenräumen, die ein Gesundheitsrisiko beim Atmen darstellen, aufgelistet in einer Klassifikation von A+ (sehr schwache Emission) bis Klasse C (hohe Emission).

GAMME* RANGE* PALETTE*	N° DE RAPPORT REPORT NUMBER BERICHTSNUMMER	ÉTIQUETAGE LABELING KENNZEICHNUNG
Reflét Laqué®	M101271	
Rêves Satinés	M101271	
Les Recyclés®	M101271	
Les Mats Tradition®	M101271	
Les Daims Ambiance®	M101271	
Les Effets Matière®	M101271	
Creadesign®	M101271	
Les Metals®	M101271	
Les Translucides	M101271	
Les Effets Lumière®	M101271	
Print your Mind®	M101271	
Mirror®	N100718	
Microsorber®	4000082964	
Tremprovision®	M101271	
Trempoacoustic®	M101271	
Biosourcée®	P178749	
ELT3D®	P161362	
Grs®	P178749	
Artolis®	P107641	
Artolis® Bi-stretch	P178749	

\* Toutes nos gammes peuvent être acoustiques et perforées - \* All our ranges can be acoustic and perforated - \* Alle unsere Bereiche können akustisch und perforiert sein



## Notre engagement responsable Our responsible commitment Unser verantwortungsvolles Engagement

Dans la continuité de notre engagement pour la protection de l'environnement, Barrisol® Normalu® est, depuis sa création, à côté de l'usine hydroélectrique de Kembs. L'électricité que nous consommons provient de cette centrale et de ce fait, nous utilisons comme énergie électrique celle produite par la force de l'eau. Sans pollution et 100% renouvelable, cette source d'énergie permet à Barrisol® de fabriquer ses murs et plafonds qui rendront vos intérieurs encore plus beaux et fonctionnels, tout en respectant l'environnement grâce aux produits Barrisol® 100% recyclables.

In line with our commitment to protecting the environment, Barrisol® Normalu® since its creation, has been next to the Kembs hydropower plant. The electricity that we consume comes from this plant and therefore is created from Water, Pollution-Free and 100% renewable, this energy source allows Barrisol® to manufacture walls and ceilings that make your interiors even more beautiful and functional, while making the environment with our products Barrisol® 100% recyclable.

Im Einklang mit unserem Engagement für den Umweltschutz, bezieht Barrisol® Normalu® seine Energie, seit Gründertagen, von dem Wasserkraftwerk Kembs. Unser Strom wird aus rein regenerativer Energie mittels Wasserkraft erzeugt. Umweltfreundlich und zu 100% erneuerbar. Diese Energiequelle ermöglicht Barrisol®, Wände und Decken zu fertigen, die Ihre Innenräume noch schöner und funktioneller machen und gleichzeitig die Umwelt schonen. Darüber hinaus sind Barrisol® Produkte zu 100% recycelbar.



Certificat officiel d'EDF confirmant que nous utilisons de l'énergie 100% recyclable  
Official EDF (french electricity) certificate confirming that we use 100% recyclable energy  
Offizielles Zertifikat von EDF (französischer Strom) bestätigt, dass wir 100% wiederverwertbare Energie verwenden

**Barrisol® leader mondial du plafond tendu** garantit le respect de l'environnement  
**World leader of stretched ceiling** guarantees the respect of environment  
**Weltweit Nr. 1 im Bereich Spanndecken** garantiert einen respektvollen Umgang mit der Umwelt

LE POIDS - WEIGHT - GEWICHT		BARRISOL®	AUTRES TYPES DE PLAFONDS OTHER TYPES OF CEILINGS - ANDERE DECKENTYPEN
		500g/m <sup>2</sup>	12kg/m <sup>2</sup>
	pour - for - für 10 000 m <sup>2</sup>	5 t	120 t
115t de matière première en moins pour couvrir une même surface de 10 000 m <sup>2</sup> 115 tons less of raw material to cover a same surface of 10 000 sqm - 115t weniger Rohstoff für die Bespannung derselben Fläche von 10 000 m <sup>2</sup>			
L'EMBALLAGE - PACKAGING - VERPACKUNG		50 kg Emballage réduit - reduced packaging - weniger Verpackung Peu de déchets - almost no waste - weniger Müll	Plus de - more than - mehr Emballages volumineux de diverses natures - Bulky various packagings - sperrige Verpackungen verschiedener Art Déchets nombreux - lot of waste - viel Müll
		Différence : près d'une tonne - Difference : nearly 1 ton - Unterschied: fast eine Tonne	
LE TRANSPORT - TRANSPORTATION - TRANSPORT		volume réduit - reduced volume - geringeres Volumen	volume important - Significant volume - großes Volumen
Transport du matériel Transport of the material - Transport des Matériels	Véhicule + léger - small vehicles - kleinere Fahrzeuge Moins de carburant consommé - less fuel consumed - weniger Kraftstoffverbrauch	Gros véhicules - large vehicles - große Fahrzeuge Consommation de carburant importante - significant fuel consumption - hoher Kraftstoffverbrauch	
Différence : gain en volume et carburant - Difference : gains in weight and fuel - Unterschied: Einsparung an Volumen und Kraftstoff			
LE MONTAGE - ASSEMBLY - MONTAGE		50 jours - days - Tage Coûts réduits - reduced costs - geringere Kosten Locaux réutilisables rapidement - premises are quickly reusable - schnell wieder nutzbare Räumlichkeiten	80 - 100 jours - days - Tage Gourmand en électricité - high need of energy - hoher Energieverbrauch Longue occupation des locaux - long building occupation - lange Blockierung der Räumlichkeiten
pour 10 000 m <sup>2</sup> avec 4 personnes for 10 000 sqm with 4 persons für 10 000 m <sup>2</sup> mit 4 Personen		Différence : besoin d'énergie réduit - Difference : reduced need of energy - Unterschied: geringerer Energiebedarf	
LES DECHETS - WASTE - MÜLL		déchets engendrés par la pose de 10 000 m <sup>2</sup> waste generated by the installation of 10 000sqm beim Verlegen von 10 000 m <sup>2</sup> anfallender Müll	+/- 0
		≈ 10 t	
déchets engendrés par la production de matériel waste generated by the production of material bei der Herstellung des Materials anfallender Müll		+/- 0	10%
Différence : très peu de déchets - Difference : almost no waste - Unterschied: sehr wenig Müll			
LA LONGEVITE - DURABILITY - LANGLEBIGKEIT		20 ans et + 20 years and more - 20 Jahre und mehr	5 - 10 ans - years - Jahre
		Pas de rénovation régulière - no regular renovation - keine regelmäßige Renovierung Pas de saleté - no dirt - kein Schmutz Pas de déchet - no waste - kein Müll	Rénovation régulière - regular renovation - regelmäßige Renovierung + de saleté - more dirt - mehr Schmutz + de déchets - more waste - mehr Müll
Différence : pas de rénovation - Difference : no renovation is needed - Unterschied: keine Renovierung notwendig			
LE RECYCLAGE - RECYCLING - RECYCLING		100% recyclable - 100% recyclable - 100% recycelbar	Tri nécessaire - Sorting is necessary - Mülltrennung erforderlich
		Préserve l'environnement - preserve the environment - schont die Umwelt Réutilisable en tant que source d'énergie - reusable as energy source - wiederverwendbar als Energiequelle	Déchets non réutilisables (gravats) - no reusable waste (rubble) - Müll nicht wiederverwendbar (Bauschutt)
Différence : 100% recyclable - Difference : 100% recyclable - Unterschied: 100% recycelbar			





## L'EMBALLAGE - PACKAGING - VERPACKUNG

### Barrisol®

### autres types de plafonds other types of ceilings andere Decken

pour 10 000 m<sup>2</sup>  
for 10 000 m<sup>2</sup>  
für 10 000 m<sup>2</sup>

50 kg

plus de 1 000 kg  
more than 1 000 kg  
mehr als 1 000 kg



emballage réduit  
reduced packaging  
geringe Verpackung

emballage volumineux  
et de diverses natures  
bulky various packagings  
umfangreiche Verpackung

peu de déchets  
almost no waste  
kaum Abfall

déchets nombreux  
lot of waste  
verschiedenartige Abfälle

**différence : PRÈS D'UNE TONNE**  
*difference: NEARLY 1 TON*  
**Unterschied : MEHR ALS 1 TONNE**



## LE POIDS - WEIGHT - GEWICHT

### Barrisol®

### autres types de plafonds other types of ceilings andere Decken



poids pour  
10 000 m<sup>2</sup>  
weight for  
10 000 m<sup>2</sup>  
Gewicht für  
10 000 m<sup>2</sup>

0.5 kg/m<sup>2</sup>  
5 t

12 kg/m<sup>2</sup>  
120 t

115 t de matière première en moins pour  
couvrir une même surface de 10 000 m<sup>2</sup>  
*115 tons less of raw material to cover  
a same surface of 10 000 m<sup>2</sup>*

115 Tonnen weniger Rohstoffe zur  
Abdeckung der gleichen Oberfläche von  
10 000 m<sup>2</sup>



## LE RECYCLAGE - RECYCLING - WIEDERVERWERTBARKEIT

### Barrisol®

### autres types de plafonds other types of ceilings andere Decken

recyclage - recycling -  
Recyclbar

100 % recyclable  
100 % recyclable  
100 % recycelbar

tri nécessaire  
sorting necessary  
Müllentsorgung notwendig



préserve l'environnement,  
réutilisable en tant que  
source d'énergie  
*preserve the environment,  
reusable as energy source*  
Erhaltung der Umwelt

déchets non réutilisables  
(gravats)  
*non reusable waste (rubble)*  
Abfälle nicht wiederverwen-  
dbar

**100 % RECYCLABLE**  
**100 % RECYCLABLE**  
**100 % RECYCELBAR**

Très légers (180 g/m<sup>2</sup>), les plafonds tendus Barrisol® sont faciles à transporter.

Les frais de transport et d'énergie sont faibles.

Les toiles Barrisol® sont recyclables, n'ont pas besoin d'être peintes et leur longévité dépasse les 20 ans. Leur montage n'engendre pratiquement pas de déchets.

**Very light (180 g/m<sup>2</sup>), Barrisol® stretch ceilings are easy to transport. The cost of transport and energy usage are low. Barrisol® membranes are recyclable, do not need to be painted and their durability exceeds 20 years. There is nearly no waste when the ceiling is mounted.**

Das geringe Gewicht (180 g/m<sup>2</sup>) der Barrisol® Spanndecken wirkt sich günstig auf Aufwand und Kosten für den Transport aus. Die Barrisol® Folien sind recycelbar, müssen nicht gestrichen werden und haben eine mittlere Lebensdauer von 20 Jahren. Die Montage verursacht nahezu keinen Abfall.





## LE TRANSPORT - TRANSPORTATION - TRANSPORT

### Barrisol®

autres types de plafonds  
other types of ceilings  
andere Decken

transport du matériel  
transport of the material  
transport des Materials

volume réduit  
reduced volume  
reduziertes Gewicht

volume important  
significant volume  
erhebliches Gewicht



véhicule plus léger  
lighter vehicles  
leisteren Fahrzeuge

gros véhicule  
large vehicles  
schwere Transportfahrzeuge

moins de carburant consommé  
less fuel consumed  
weniger Treibstoffverbrauch

consommation de carburant importante  
significant fuel consumption  
hoher Treibstoffverbrauch

**GAINS EN VOLUME ET CARBURANT**  
**GAINS IN WEIGHT AND FUEL**

**WENIGER GEWICHT BEDEUTET, WENIGER TREIBSTOFF**



## LES DÉCHETS - WASTE - ABFALL

### Barrisol®

autres types de plafonds  
other types of ceilings  
andere Decken

déchets engendrés  
par la pose de 10 000 m<sup>2</sup>  
waste generated  
by installation of 10 000 m<sup>2</sup>  
Abfallaufkommen  
bei der Verlegung von 10  
000 m<sup>2</sup>

+/- 0

≈ 10 t

déchets engendrés  
par la production de matériel  
waste generated  
by production of material  
Abfallaufkommen bei  
der Produktion des Materials

+/- 0

10 %



**TRÈS PEU DE DÉCHETS**  
**ALMOST NO WASTE**  
**KEIN ABFALL**



## LE MONTAGE - ASSEMBLY - MONTAGE

### Barrisol®

autres types de plafonds  
other types of ceilings  
andere Decken

montage de 10 000 m<sup>2</sup> avec  
4 personnes  
assembly of 10 000 m<sup>2</sup>  
with 4 assemblers  
Montage von 10 000 m<sup>2</sup>  
mit 4 Monteuren

50 jours  
50 days  
50 Tage

80 à 100 jours  
80 to 100 days  
80 bis 100 Tage



coûts réduits  
reduced costs  
reduzierte Kosten

gourmand en électricité  
high need of energy  
hoher Energieverbrauch

locaux réutilisables  
rapidement  
premises are quickly  
reusable  
Räume schnelles  
wiedernutzbar

longue occupation des locaux  
long building occupation  
lange Ausfallszeiten der Räume

**PEU DE BESOIN D'ÉNERGIE**  
**LOW NEED OF ENERGY**  
**GERINGE AUSFALLZEITEN**



## LONGÉVITÉ - DURABILITY - LEBENSDAUER

### Barrisol®

autres types de plafonds  
other types of ceilings  
andere Decken

20 ans et plus  
20 years and more  
20 Jahre und mehr

5 à 10 ans  
5 to 10 years  
5 bis 10 Jahre

pas de rénovation régulière  
no regular renovation  
keine Renovierungskosten

rénovation régulière  
regular renovation  
regelmäßige Renovierung

pas de saleté  
no dirt  
keine Schmutz

plus de saleté  
more dirt  
mehr Schmutz

pas de déchets  
no waste  
keine Abfall

plus de déchets  
more waste  
mehr Abfall



**PAS DE RÉNOVATION**  
**NO RENOVATION IS NEEDED**  
**KEINE RENOVIERUNG ERFORDERLICH**



Arch. : Drieskens &amp; Dubois Architects



Réalisation : Essenciel

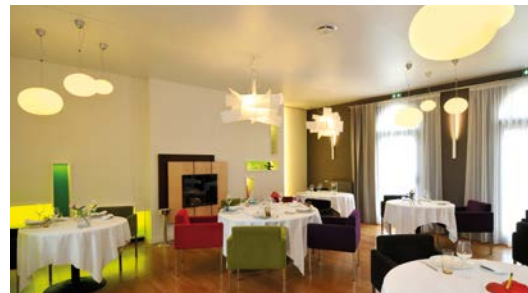

Arch. : Cabinet Boissiere et Gaulay

# Barrisol®

## Les Recyclés®

### The Recycled ■ Die Recycelten



50% pre-consumer (toile / sheet / Spannfolie)  
up to 100% post-consumer (structure / structure / Struktur)



Beltherm

Grand Hôtel  
La Cloche

Barrisol® accorde depuis longtemps une grande importance au respect de l'environnement. De plus, l'ensemble des matériaux utilisés pour la production est recyclable ou fait de matières recyclées (emballages, conditionnements...).

La gamme de toiles « Les recyclés » va encore plus loin puisqu'en plus d'être recyclable à 100% comme toutes les autres toiles Barrisol®, elles sont fabriquées à partir de matières Barrisol® recyclées (50% pre-consumer).

Les toiles « Les recyclés » sont destinées à équiper non seulement les bâtiments labellisés « développement durable », mais aussi tous les types de constructions pour lesquelles le souci de contribuer à la préservation de l'environnement est présent à l'esprit des promoteurs.

Since the beginning Barrisol® can claim its ecological commitment by respecting the environment. Furthermore, the raw material used for production are recyclable or made with recycled materials (packaging, shipping packing...).

"The recycled" range of membranes goes even further, in addition to being 100% recyclable like all other Barrisol® membranes, they are made from recycled Barrisol® materials (50% pre-consumer).

"The Recycled" sheeting can be installed in "sustainable development" certified buildings and also in all types of construction which contribute to the protection of the environment.

Barrisol® setzt sich seit langem konsequent für Umweltschutz ein. Deshalb verwenden wir in der Produktion nur recycelbare Werkstoffe oder recyceltes Material (Verpackungen, Aufmachungen...).

Die Spannfolien des Sortiments „Les Recyclés“ gehen noch einen Schritt weiter, denn sie sind nicht nur zu 100 % recycelbar wie alle anderen Spannfolien von Barrisol®, sondern werden auch aus bereits recycelten Barrisol® Materialien hergestellt (50 % gebrauchtes Material).

Die Gewebe „Les Recyclés“ sind nicht nur für Gebäude mit dem Gütesiegel „Nachhaltige Entwicklung“ bestimmt, sondern auch für alle Arten von Bauwerken, deren Projektträger einen Beitrag zur Bewahrung der Umwelt leisten möchten.



VIDEO



Réalisation : Kordekor



Arch.: Studio ADN Architecture Design Nomade

Écologie  
Ecology  
Ökologie



	Barrisol®	autres types de plafonds - other types of ceilings - andere Decken
Poids Weight Gewicht	<b>0.5kg/m<sup>2</sup></b>	12kg/m <sup>2</sup>
pour - for - für <b>10 000 m<sup>2</sup></b>	<b>5 t</b>	120 t
<b>115 tonnes de matière première en moins 115 tons less of raw material 115 Tonnen weniger Rohstoffe</b>		

### CARACTÉRISTIQUES TECHNIQUES - TECHNICAL INFORMATION- TECHNISCHE INFORMATION

Composition toile / Sheet composition /  
Zusammensetzung Spannfolie

#### Pre-consumer 50%

50% de matières recyclées - 50% PVC originel  
50% recycled materials - 50% virgin PVC  
50% recycelte Materialien - 50% reines PVC

Profil d'accrochage et structures /  
Profile and structures / Befestigungsprofil und Strukturen

#### Post-consumer up to 100%

Recyclables jusqu'à 100% - up to 100% recyclable - Recyclbar bis zu 100 %



R02 Blanc Neige



R01 Beige Sable

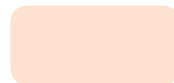

R05 Rose Fleur



R06 Vert Nature



R07 Bleu Ciel



R03 Gris Perle



R04 Noir Crepuscule

#### ACOUSTICS®

A15 - A20 - A30 : ≤ 220 cm

A40 : ≤ 200 cm.

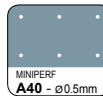
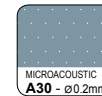
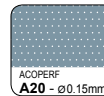
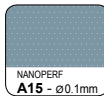

#### PERFORATIONS - PERFORATIONS - PERFORATIONEN - PERFORAZIONE - PERFORACIÓN

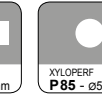
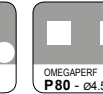
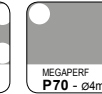
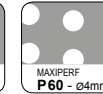
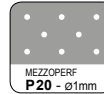
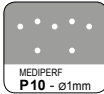

Taux de réflexion de la lumière - Light reflexion rate

Lichtreflexionsgrad - Tasso di riflessione della luce - Porcentaje de reflexión de luz

R02 Blanc 90%

Norme - Norm - Norm - Normativa - Normativa : ASTM E903 - NF EN 410

\* Vous pouvez nous faire parvenir vos toiles et profilés Barrisol® en fin de vie, nous nous engageons à les réutiliser, recycler et réduire les déchets, pour la préservation de notre environnement.

\* You can send us your end of life Barrisol membranes and profiles, we commit to recycle and use them again to reduce waste and thus preserve our environment.

\* Sie können uns ihre Gewebe und Profileisten von Barrisol® mit abgelaufener Lebensdauer zurückgeben, wir kümmern uns um die Wiederverwertung. So verringern wir den Abfall zum Schutz unserer Umwelt.





Arch. : Space 9

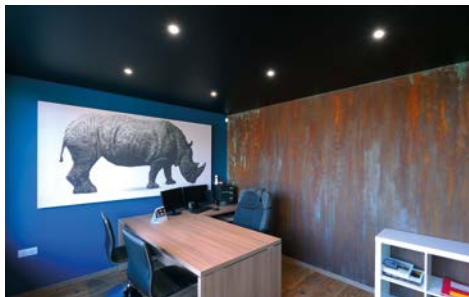

Réalisation : Barrisol®



Réalisation : Kordekor

# Barrisol®

## Biosourcée® ■ Biosource ■ Die Biobasierte

Plastifiant d'origine végétale ■ Plasticizing agent of vegetable origin  
Pflanzlicher Weichmacher



La toile Biosourcée® est le produit idéal pour le Barrisol Clim®  
The biosourced membrane it's the ideal product for the Barrisol Clim®  
Die Barrisol Folie ist das ideale Produkte für der Barrisol Clim®



HTC Headquarters

Les toiles de la gamme Biosourcée® contiennent dans leur composition un plastifiant d'origine végétale à base de céréales. Nous protégeons l'environnement depuis plus de 50 ans en utilisant que des matériaux 100% recyclables.

Le plastifiant d'origine végétale rentre dans la composition de la toile Biosourcée® satinée jusqu'à 30% et jusqu'à 10% pour la version translucide.

Nous proposons également des profilés faits en aluminium post-recyclé à plus de 80%, rendant le circuit de réutilisation des matières premières encore plus respectueux de l'environnement.

Les tests garantissant la climatisation ont été réalisés avec la toile Biosourcée®, il est donc le produit idéal, de par sa composition, pour le Barrisol® Clim®. De plus, les toiles Biosourcée® sont conformes au test ODDY.

Our range of fabrics "Bio-based" contain in their composition a plasticizer of plant origin, cereal based. We have been protecting the environment for over 50 years using only 100% recyclable materials.

The plant based plasticizer used in the composition of the satin bio-based membrane up to 30% and up to 10% for the translucent version.

Our profiles on aluminium are recyclable up to 80% (post-consumer), making the reuse circuit of raw materials more respectful for the environment. The tests guaranteeing climatization have been realized with the biosourced membrane, it's therefore the ideal product, by its composition, for the Barrisol® Clim®. In addition, Biosourcée® membranes complies with ODDY test.

Die Spannfolie des Sortiments Biosourcée® enthalten in ihrer Zusammensetzung einen pflanzlichen Weichmacher auf Getreidebasis. Indem wir nur 100 % recycelbare Materialien verwenden, schützen wir die Umwelt seit über 50 Jahren.

Der Anteil des pflanzlichen Weichmacher in der Spannfolie Biosourcee® beträgt in der Version Seidenglanz bis zu 30 % und in der transluzenten Version bis zu 10 %.

Wir bieten außerdem Profileleisten mit einem Anteil an recyceltem Aluminium von über 80 %, was den Wiederverwertungskreislauf der Rohstoffe noch umweltfreundlicher gestaltet. Die biobasierte Spannfolie wurde in Bezug auf Belüftungsqualität geprüft und erwies sich aufgrund seiner Zusammensetzung als das ideale Produkt für die Decke Barrisol® Clim®. Darüber hinaus sind Biosourcée®-Folien konform mit den ODDY-Test.



VIDEO



Arch. : Kris yao Architect



Design : Groupe Accor

**CARACTÉRISTIQUES TECHNIQUES - TECHNICAL INFORMATION - TECHNISCHE INFORMATION**



**BOS 01** Arctic



**BOT 05** Atlas



**BOL 01** Blanc Edelweiss



**ACOUSTICS®**

A15 - A20 - A30 :  $\leq 220$  cm

A40 :  $\leq 200$  cm.

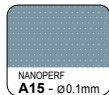

**NANOPERF**  
**A15** -  $\phi 0.1$ mm

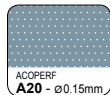

**ACOPERF**  
**A20** -  $\phi 0.15$ mm

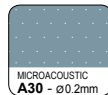

**MICROACOUSTIC**  
**A30** -  $\phi 0.2$ mm

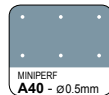

**MINIPERF**  
**A40** -  $\phi 0.5$ mm

**PERFORATIONS - PERFORATIONS - PERFORATIONEN - PERFORAZIONE - PERFORACIÓN**

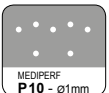

**MEDIAPERF**  
**P10** -  $\phi 1$ mm



**MEZZOPERF**  
**P20** -  $\phi 1$ mm



**SOLAPERF**  
**P50** -  $\phi 2.8$ mm



**MAXIPERF**  
**P60** -  $\phi 4$ mm

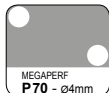

**MEGAPERF**  
**P70** -  $\phi 4$ mm



**OMEGAPERF**  
**P80** -  $\phi 4.5$ mm



**XYLOPERF**  
**P85** -  $\phi 5$ mm

\* Vous pouvez nous faire parvenir vos toiles et profilés Barrisol® en fin de vie, nous nous engageons à les réutiliser, recycler et réduire les déchets, pour la préservation de notre environnement.

\* You can send us your end of life Barrisol membranes and profiles, we commit to recycle and use them again to reduce waste and thus preserve our environment.

\* Sie können uns ihre Die biobasierte Spanntolie und Profileisten von Barrisol® mit abgelaufener Lebensdauer zurückgeben, wir kümmern uns um die Wiederverwertung. So verringern wir den Abfall zum Schutz unserer Umwelt.



Design : Groupe Brayé - Architecte d'intérieur : Edith Grese



Arch. : Pauline Percheron



Arch. : Bontinck



# Barrisol® Clim®

la garantie du n°1 Mondial du plafond tendu  
 the guarantee of the n°1 World of the stretched ceiling  
 Die Garantier der weltweiten Nr. 1 in Spanndecken



1<sup>er</sup> place en Développement Durable  
 en partenariat avec Baitykool  
 1<sup>st</sup> place in Sustainability  
 in partnership with Baitykool  
 1. Platz in Nachhaltigkeit Entwicklung  
 in Partnerschaft mit Baitykool

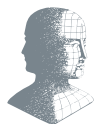

JANUS 2017  
 DE L'INDUSTRIE



1<sup>er</sup> place en Efficacité Énergétique  
 en partenariat avec Baitykool  
 1<sup>st</sup> place in Energy Efficiency  
 in partnership with Baitykool  
 1. Platz in Energieeffizienz  
 in Partnerschaft mit Baitykool



Version Française



English version



Deutsche Version



US Version



Versione italiana



Versión española



Bijouterie  
 Guillosson

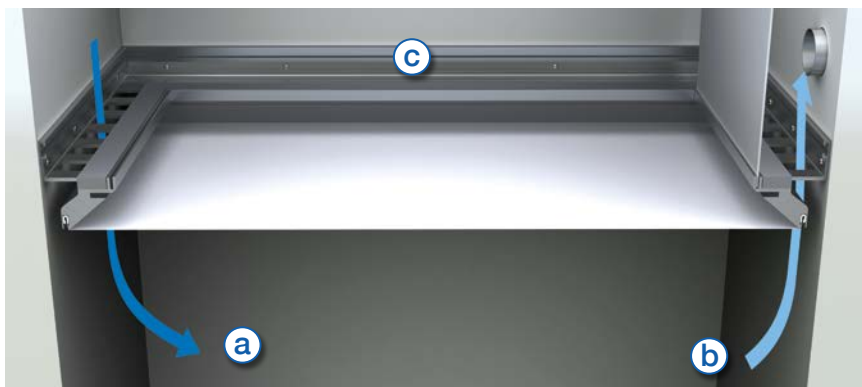
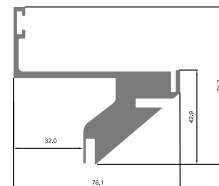
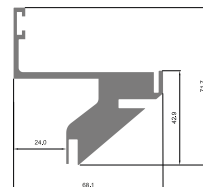
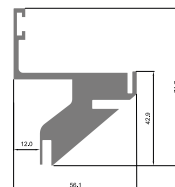

Grâce à sa forme ajourée brevetée, Barrisol Clim® permet un passage d'air en soufflage **a** ou en aspiration **b** entre le volume du plénum et celui de la pièce. La version non ajourée **c** du profilé permet d'interdire le passage d'air sur certaines parois.

With its patented slotted profile, Barrisol Clim® transfers air either as Forced Air **a** or Return Air **b** between the plenum space and that of the room. The solid version **c** of the profile allows to prevent the passage of air through certain walls.

Dank seiner einzigartig patentierten Form mit Durchbrüchen ermöglicht Barrisol Clim® eine Lufteströmung durch Zuluft **a** bzw. Abluft **b** zwischen dem Hohlraumvolumen und dem Raum selbst. Die Ausführung der Profileiste ohne Durchbrüche **c** verhindert die Lufteströmung bei bestimmten Wänden.



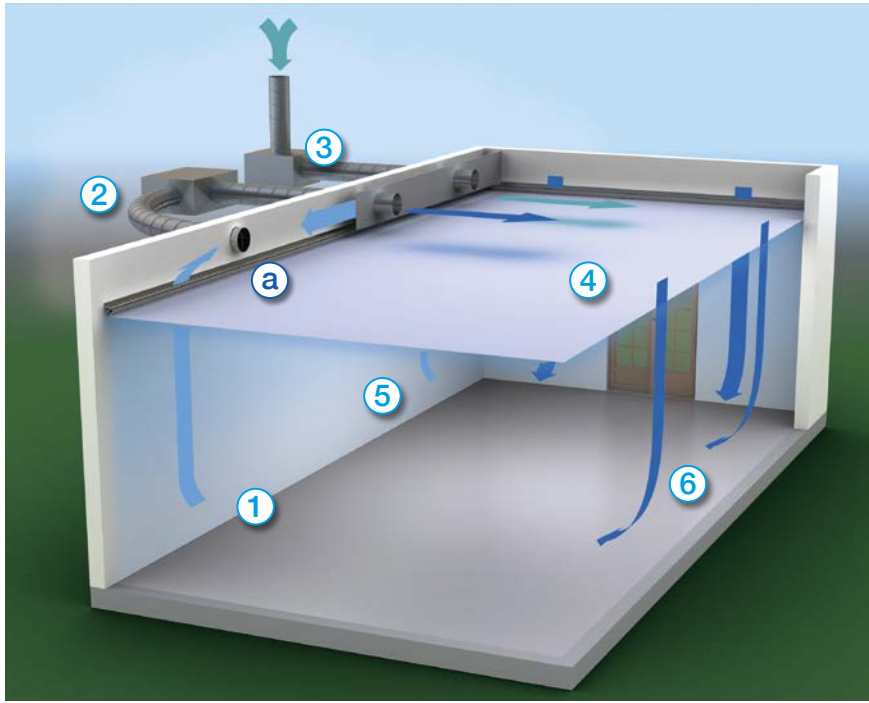

Arch. : Bertine Creemers - PUUR Binnenhuisarchitectuur

- ① L'air ambiant est aspiré le long des parois intérieures de la pièce, puis canalisé au moyen d'une paroi de séparation **a** supportée par le profilé spécial Barrisol Clim®.
- ② L'air aspiré rejoint l'unité de climatisation\*, il est filtré puis chauffé ou refroidi avant d'être diffusé dans le plénum compris entre la dalle haute et le plafond Barrisol Clim®.
- ③ Un caisson de ventilation peut être connecté au système pour injecter de l'air neuf hygiénique dans le plénum.
- ④ L'air conditionné et l'air neuf forment un mélange homogène, réparti dans l'ensemble du volume du plénum.
- ⑤ Le plafond Barrisol Clim® devient un immense diffuseur, rayonnant sur toute sa surface.
- ⑥ L'air climatisé descend lentement le long des parois extérieures.

- ① Ambient air is drawn along the interior walls of the room, then channelled by means of a separating bulkhead **a**, supporting the special Barrisol Clim® profile.
- ② The air enters the air conditioning unit\*, where it is filtered then heated or cooled before being released in the plenum between the slab above and the Barrisol Clim® ceiling.
- ③ A ventilation box can be connected to the system to inject hygienic new air into the plenum.
- ④ The conditioned air blends effectively with the new air and is distributed throughout the volume of the plenum.
- ⑤ The Barrisol Clim® ceiling becomes one huge diffuser, radiating heat or coolness across the entire surface.
- ⑥ The conditioned air flows slowly over the outer walls.

- ① Die Umgebungsluft wird entlang der Innenwände des Raums angesaugt und dann mittels einer Trennwand **a**, die von einer Barrisol Clim®-Spezialprofileiste getragen wird, kanalisiert.
- ② Die angesaugte Abluft gelangt in die Klimatisierungseinheit\*, wird gefiltert und danach erwärmt bzw. gekühlt, bevor sie im Hohlraum zwischen der bestehenden Decke und der Barrisol Clim®-Spanndecke verteilt wird.
- ③ An das System kann ein Lüftungskasten angeschlossen werden, um saubere Frischluft in den Deckenhohlraum zu leiten.
- ④ Die klimatisierte Luft und die Frischluft bilden ein einheitliches Temperaturkissen, das sich über den gesamten Deckenhohlraum erstreckt.
- ⑤ Die Barrisol Clim®-Decke wird zu einem großflächigen Verteiler, der über die gesamte Oberfläche des Raums strahlt.
- ⑥ Die klimatisierte Luft strömt langsam von oben nach unten an den Außenwänden entlang.

\* Le système Barrisol Clim® est compatible avec toutes les technologies de production de chaud et de froid par air soufflé. Contactez votre installateur Barrisol® agréé, pour plus d'information.

\* The Barrisol Clim® system is compatible with all hot- and cold-air production technologies which use forced air. Contact your approved Barrisol® installer for more information.

\* Das Barrisol Clim®-System ist mit allen Technologien zur Erzeugung von Warm- und Kaltluftzufuhr kompatibel. Für weitere Informationen, wenden Sie sich bitte an Ihren zugelassenen Barrisol®-Installateur.

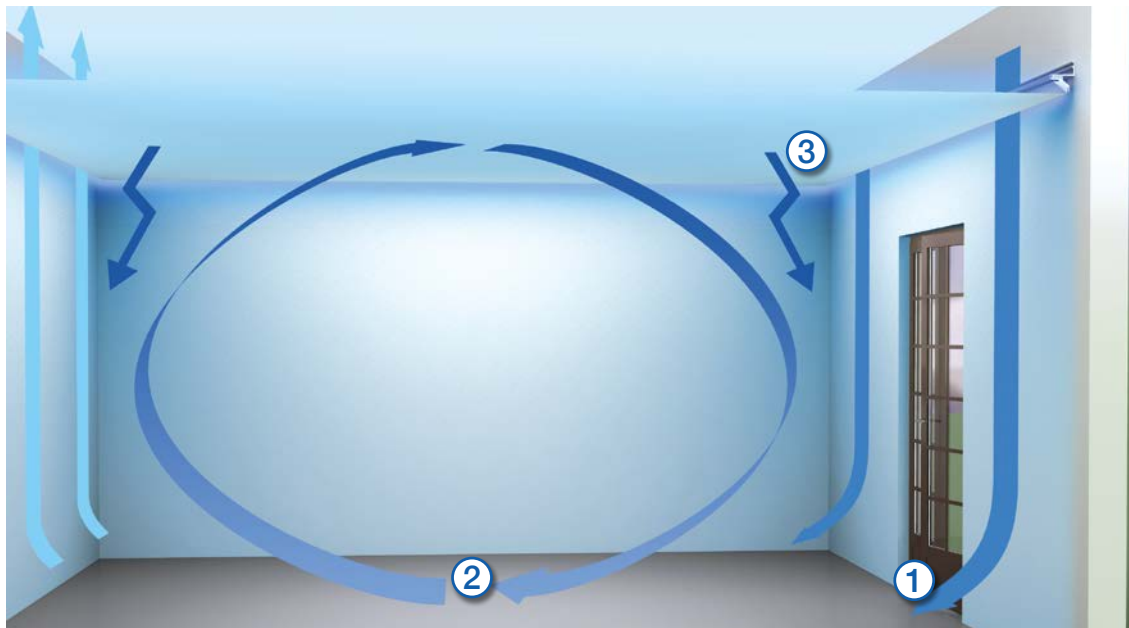

- ① En été comme en hiver, le flux d'air conditionné effleure les parois extérieures. Les phénomènes désagréables de parois chaudes ou froides disparaissent.
- ② Un mouvement d'air naturel se crée dans le volume de la pièce, à des vitesses très lentes, quasi-imperceptibles.
- ③ L'ensemble de la surface du plafond rayonne, générant une agréable et douce sensation de chaleur ou de fraîcheur.

- ① Whether in summer or winter, conditioned air will flow gently over the outer walls. This eliminates any unpleasantly hot or cold walls.
- ② A natural flow of air develops throughout the space inside the room, at speeds so low they are barely perceptible.
- ③ Heat radiates through the entire surface of the ceiling, providing pleasant, gentle heat or coolness.

- ① Im Sommer wie im Winter strömt die klimatisierte Luft an den Außenwänden entlang. Unangenehme Effekte wie warme oder kalte Wände verschwinden.
- ② Im Raum entsteht eine natürliche Luftbewegung, die sehr langsam und deswegen quasi unbemerkt erfolgt.
- ③ Die gesamte Deckenfläche gibt Strahlung ab und erzeugt ein angenehm kühles oder warmes Gefühl.

Exemple de distribution thermique du système  
An example of the thermal distribution provided  
by the system  
Beispiel für die thermische Verteilung des Systems

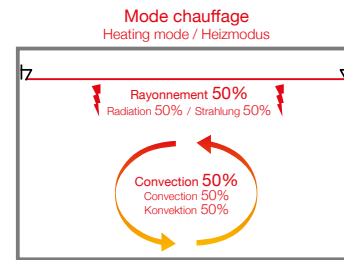
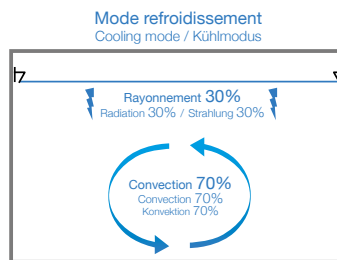

Les températures de parois homogènes, l'alliance du mouvement d'air naturel et la grande surface de rayonnement du plafond, tout concourt avec Barrisol Clim® à un confort sans égal en chauffage comme en refroidissement. Les occupants sont enveloppés par une douce sensation de fraîcheur ou de chaleur, dans le plus grand silence et sans courant d'air. Le rayonnement du plafond confère au système une réactivité incroyable, en seulement quelques minutes la sensation de chaud ou de froid est perceptible.

Thanks to the consistent wall temperatures, the natural air flow and the large heat-exchanging surface of the ceiling, Barrisol Clim® provides unparalleled comfort whether heating or cooling your home. Occupants are surrounded by a gentle sensation of warmth or coolness. There is no noise and no air disturbance. The ceiling works to radiate the heat or coolness extremely quickly. You'll feel a notable change in temperature within minutes.

Aufgrund der gleichmäßigen Wandtemperaturen und der Kombination zwischen natürlicher Luftbewegung und großer Strahlungsfläche der Decke, bietet Barrisol Clim® ein unvergleichliches Raumklima, sowohl bei der Heizung als auch bei der Kühlung. Die Raumnutzer sind in absoluter Stille und ohne Zugluft von angenehmer Kühle bzw. Wärme umgeben. Durch die Deckenstrahlung ist das System unglaublich reaktionsstark und das Gefühl von Wärme bzw. Kühle entsteht innerhalb weniger Minuten.

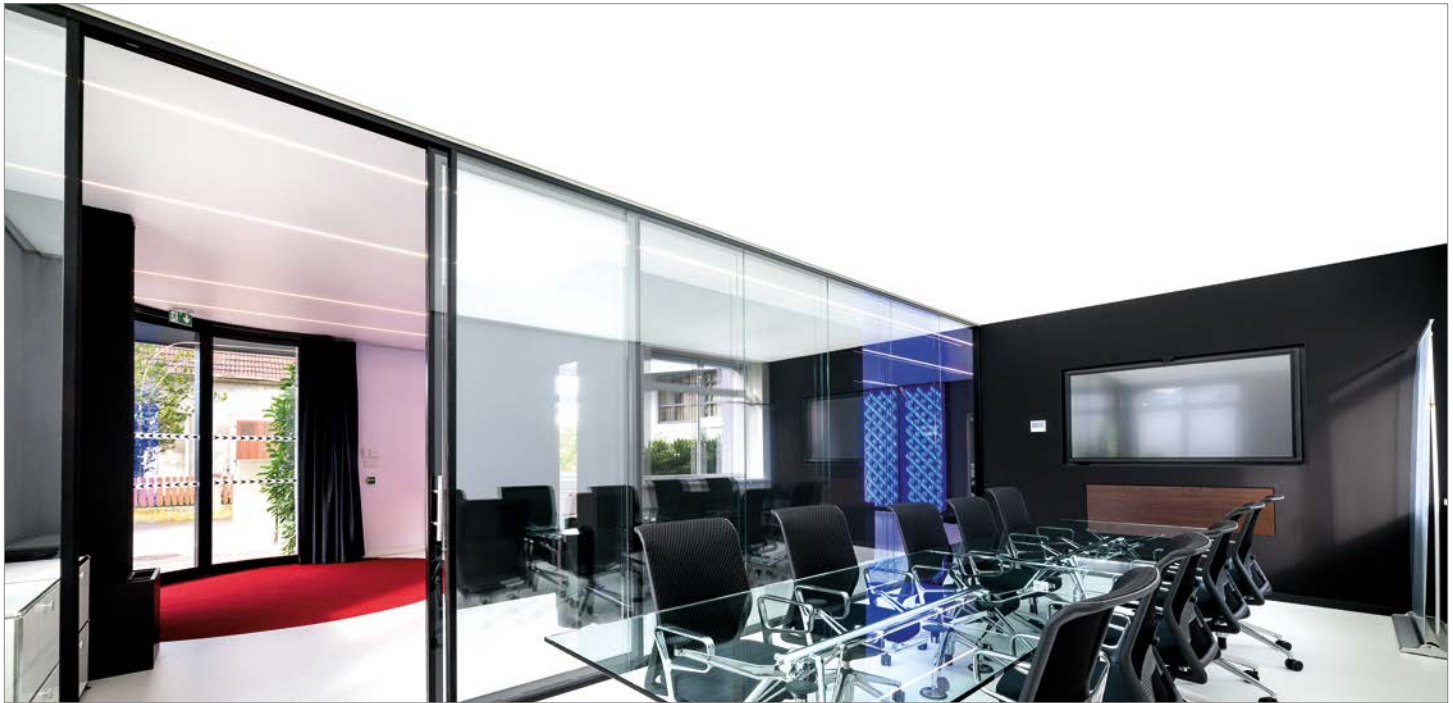

Arch. : Jean-François Brodbeck - AMRS Architectes

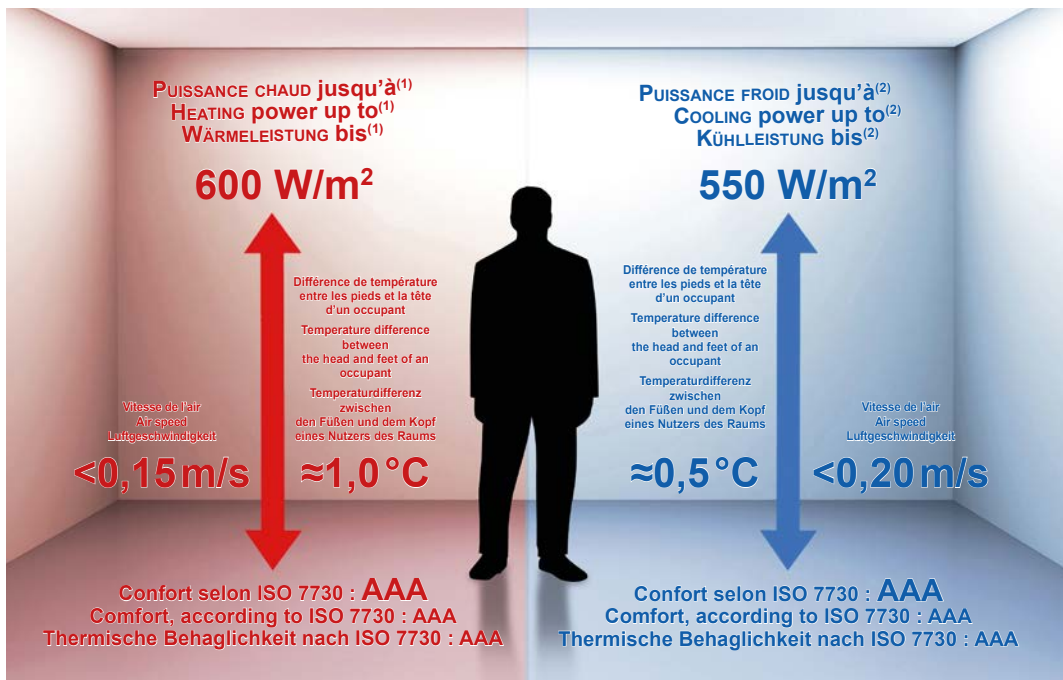

**(1) sans aucun risque de déformation du plafond tendu**

(1) with no risk of deforming the stretched sheet ceiling

(1) ohne Gefahr der Verformung der Spanndecke

**(2) sans aucun risque de condensation du plafond tendu**

(2) with no risk of condensation on the stretched sheet ceiling

(2) ohne Kondensationsgefahr der Spanndecke



Clim®  
Acoustique  
Acoustics®  
Akustik



**A15 NANOPERF®**

SIMPLE TOILE  
SINGLE-SHEET  
EINFACHER FOLIE



Designer : Arnaud Klein

VIDEO

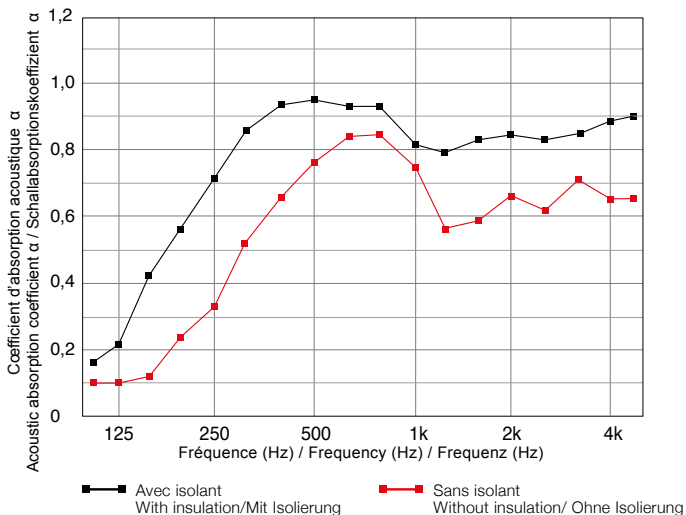
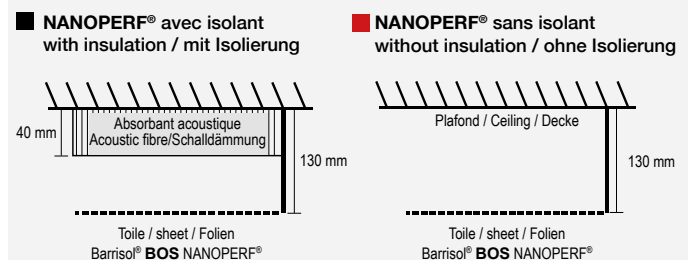

Clim®  
Lumière  
Acoustique®  
Acoustic Light®  
Das akustische  
Licht®



**A15 NANOPERF®**

DOUBLE TOILE LUMINEUSE  
LUMINOUS DOUBLE-SHEET  
DOPPELTER LICHTFOLIE



Réalisation : Kordekor

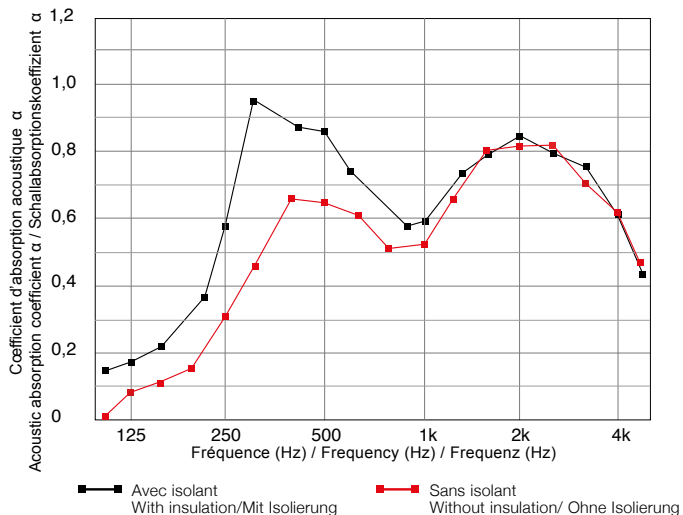
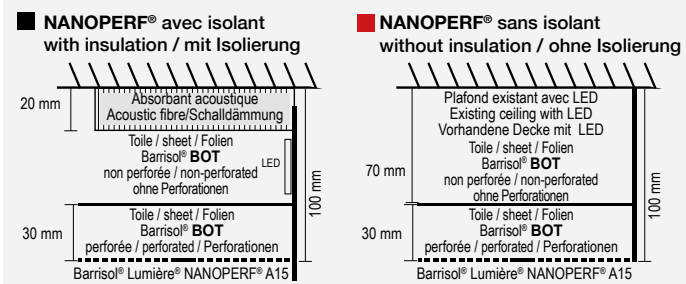

PV disponible sur simple demande / PV available upon request / Prüfprotokoll auf Nachfrage verfügbar



Arch. : MHCS



Arch. : Architectunion

## Avantages

Regroupe toutes les fonctionnalités techniques :

- Chauffage et refroidissement
- Ventilation des locaux / Free Cooling
- Toile acoustique et/ou lumineuse :  
La toile Biosourcée® étant le produit idéal pour le Barrisol Clim®
- Possibilité de diffusion du son et d'incorporation d'un vidéo projecteur

Allie esthétique et souplesse :

- Aucun élément technique disgracieux visible
- Libère les murs et les espaces des pièces à vivre
- Optimise les hauteurs de plénum

Un confort sans équivalent pour votre bien-être :

- Silencieux
- Absorption acoustique
- Température homogène en tout point de la pièce, très faible différence de température entre les pieds et la tête d'un occupant
- Rapidité et réactivité du système pour obtenir la température souhaitée
- Aucun courant d'air

Performant et économique :

- De 5 à 10% d'économie de consommation en comparaison des climatisations classiques
- Écologique (moins d'énergie, moins de matière)
- Performance **AAA froid** et **AAA chaud** selon la norme ISO 7730
- Entretien minimal

## Advantages

It handles all the technical functions in one unit:

- Heating and cooling
- Area ventilation / Free cooling
- Acoustic and/or luminous membrane:  
The biosourced membrane it's the ideal product for the Barrisol Clim®
- Option to integrate sound or projected video

Combining beauty and flexibility:

- No unsightly technical components on show
- Eliminates visible ventilation hardware.  
Frees up space on your walls and in your home
- Optimises the height of your plenum

Unparalleled comfort for enhanced well-being:

- Quiet
- Acoustic absorption
- A consistent temperature throughout
- A heightened system response time allows the unit to reach the desired temperature quickly
- No draughts

Powerful and economical:

- Uses between 5 and 10% less energy than standard air-conditioning
- Environmentally friendly (less energy, less matter)
- **AAA cold air** and **AAA heating air** performance, according to the ISO 7730 standard
- Minimal maintenance required

## Die Vorteile

Vereint alle technischen Funktionen:

- Heizung und Kühlung
- Raumbelüftung / Free Cooling
- Schalldämpfung und/oder Beleuchtung:  
Die Barrisol® Folie ist das ideale Produkte für der Barrisol Clim®
- Möglichkeit für Tonübertragung und Integration eines Videoprojektors

Kombiniert Ästhetik mit Flexibilität:

- Unansehnliche technische Vorrichtungen bleiben verborgen
- Freie Wände und Nutzflächen
- Optimierte Hohlraumtiefen

Unvergleichlicher Komfort für Ihr Wohlbefinden:

- Keine Geräuschbelästigung
- Schalldämpfung
- Gleichmäßige Temperatur überall im Raum, sehr geringe Temperaturdifferenz zwischen Kopf- und Fußbereich eines Raumnutzers
- Reaktionsstarkes System, schnelle Einstellung der gewünschten Temperatur
- Keine Zugluft

Leistungsfähig und wirtschaftlich:

- 5 bis 10 % Energieeinsparung im Vergleich zu klassischen Klimaanlage
- Ökologisch (weniger Energie, weniger Material)
- Leistung **AAA bei Kühlung** und **AAA bei Heizung** nach ISO 7730
- Minimaler Wartungsaufwand

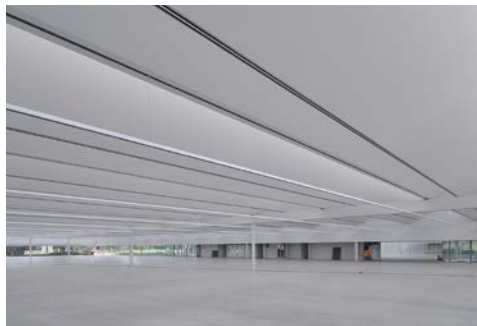

Arch. : Guido Canali



Arch. : Alessandra Foderaro



Arch. : Mikko Lemmetti

# Barrisol® Acoustics®

Solutions acoustiques ■ Acoustic solutions ■ Akustische Lösungen



Aspire



Federation Square

La gamme Barrisol Acoustics® est composée de toiles micro-perforées qui absorbent les sons et réduisent les nuisances sonores dans les lieux publics ou privés. Ces toiles réduisent l'effet de résonance et améliorent le confort acoustique. Barrisol® vous propose différentes solutions en acoustiques : Lumière Acoustique® - 3D Acoustique - Miroir acoustique - Clim® acoustique - GTs® acoustique - Print your Mind® acoustique - cadres acoustiques - cadres Artolis®.

The Barrisol Acoustics® line is composed of micro-perforated membranes which absorb sound and reduce noise pollution in public or private spaces. These membranes reduce the resonance effect and improve acoustic environment. Barrisol® offers various acoustic solutions: Acoustic Light® - Acoustic 3D - Acoustic Mirror® - Acoustic Clim® - Acoustic GTs® - Acoustic Print your mind® - Acoustic Frames - cadres Artolis®.

Das Sortiment Barrisol Acoustics® besteht aus mikroperforierten Spannfolien, die Geräusche absorbieren und den Resonanzeffekt eindämmen. So verringern sie die Lärmbelastung in öffentlichen und privaten Räumen, was den akustischen Komfort verbessert. Barrisol® bietet Ihnen verschiedene akustische Lösungen: Acoustics Light® - Acoustic 3D - Acoustic Mirror® - Acoustic Clim® - Acoustic GTs® - Acoustic Print your Mind® - Acoustic Frames - Rahmen Artolis®.



Arch. : CICO and Roger Taillibert





Arch. : Lab Architecture Studio &amp; Bates Smart

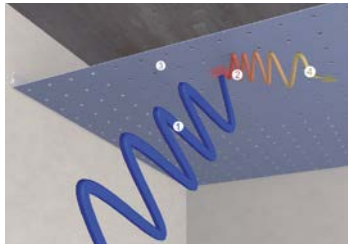

Ce principe consiste à absorber partiellement le mouvement d'air induit par la source sonore grâce aux micro-perforations de la toile qui n'en réfléchissent qu'une partie, cassant ainsi l'effet de réverbération.

The acoustic absorption characteristics of the micro-perforated membranes ensures that only a percentage of the impinging sound waves are reflected, thereby reducing the reverberation effect.

Das Prinzip besteht darin, die von der Lärmquelle verursachten Bewegungen der Luft zu dämpfen, indem die kleinen Löcher in der Spanndecke nur einen Teil des Schalls reflektieren und so den Nachhalleffekt aufbrechen.



Arch. : Kris Rymenants architectuurbureau



Arch. : CCHE Architecture



## A15 NANOPERF®

■ **NANOPERF®** sans isolant - without insulation - ohne Dämmstoff

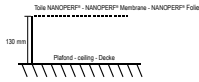

■ **NANOPERF®** avec isolant - with insulation - mit Dämmstoff

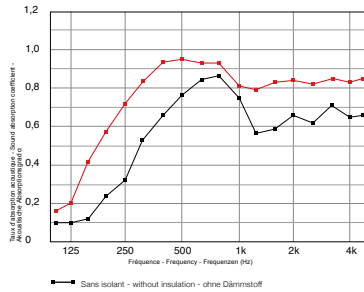
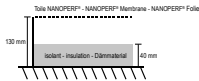

### Caractéristiques - Features - Eigenschaften NANOPERF® A15

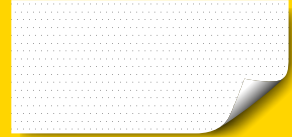

Trous - Holes - Löcher : **500 000/m<sup>2</sup>**

Diamètre d'un trou - Hole diameters - Lochdurchmesser : **≈ 0,1 mm**

Taux de perforation - Perforation rate - Perforationrate : **≈ 1 %**

Épaisseur - Thickness - Dicke : **≈ 0,18 mm**

Référence - Reference - Kennung : **A15 + réf. coloris - colour - Farbfref**



Arch. : URS Corporation

### L'aéroport de Baltimore (USA) en toile BARRISOL® NANOPERF®

Barrisol® concilie esthétique et performance acoustique dans ce lieu, vaste, haut de plafond, soumis aux perturbations sonores extérieures et intérieures. La toile Barrisol® Microperf® est optimale pour assurer les confort des usagers.

### Baltimore Airport (USA) with BARRISOL® NANOPERF®

Barrisol® fuses aesthetic and acoustic performance in this wide and high place, reducing uncomfortable noise of the crowds and outside air traffic. Barrisol® Microperf® offers a unequalled acoustic comfort to the visitors and employees of this large place.

### Flughafen Baltimore (USA) mit Membran BARRISOL® NANOPERF®

In diesem hohen und weiten Raum, der durch Menschen und Flugverkehr stark mit Lärm belastet ist, verbindet Barrisol® Ästhetik mit hoher Lärmleistung. Die Barrisol® Microperf® Decke wurde hier optimal zur Erhöhung des Komforts von Personal und Reisenden eingesetzt.

$\alpha_s$	Fréquences - Frequency - Frequenzen (Hz)						Moyenne d'absorption selon / Sound absorption Average according to / Mittlere Schalabsorption gem. ASTM C423-01	Coefficient de réduction du bruit selon / Noise Reduction Coefficient according to / Schallabsorptionskoeffizient gem. ASTM C 423-01	Coefficient d'absorption acoustique mesuré selon / Weighted sound absorption Coefficient according to / Schallabsorptionskoeffizient gemessen nach DIN EN 11654	Classe d'absorption acoustique selon / Sound Absorber class according to / Schalabsorptionsklasse gem. DIN EN 11654
	125	250	500	1000	2000	4000				
NANOPERF® Plenum 130 sans isolant - without insulation ohne Dämmstoff	0,1	0,32	0,78	0,75	0,65	0,65	SAA = 0,62	NRC = 0,60	$\alpha_w = 0,65$	C
NANOPERF® Plenum 130 avec isolant - with insulation mit Dämmstoff: 40 mm	0,2	0,72	0,95	0,81	0,83	0,82	SAA = 0,85	NRC = 0,83	$\alpha_w = 0,90$	A



## A20 ACOPERF®

■ **ACOPERF®** sans isolant - without insulation - ohne Dämmstoff

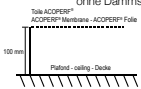

■ **ACOPERF®** avec isolant - with insulation - mit Dämmstoff

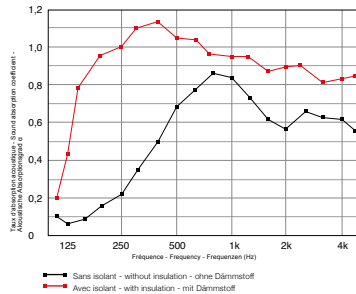
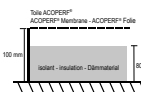

### Caractéristiques - Features - Eigenschaften ACOPERF® A20

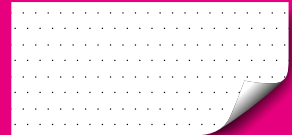

Trous - Holes - Löcher : **400 000/m<sup>2</sup>**

Diamètre d'un trou - Hole diameters - Lochdurchmesser : **≈ 0,15 mm**

Taux de perforation - Perforation rate - Perforationrate : **≈ 0,8 %**

Épaisseur - Thickness - Dicke : **≈ 0,18 mm**

Référence - Reference - Kennung : **A20 + réf. coloris - colour - Farbfref**



Arch. : Snohetta

### L'Opéra d'Oslo (Norvège) en toile BARRISOL® ACOPERF®

Prix européen d'architecture contemporaine 2009, cet édifice a été construit au bord du Fjord où il émerge du sol tel un iceberg. Le plafond tendu Barrisol Acoustics® a été installé sur une surface de 4 000 m<sup>2</sup> pour absorber les résonances acoustiques et améliorer le confort sonore dans ce bâtiment de 32 mètres de hauteur.

### Opera House of Oslo (Norway) with BARRISOL® ACOPERF® sheet

2009 European prize of contemporary architecture this building was built at the edge of the Fjord where it appears from the ground such an iceberg. The Barrisol Acoustics® sheets has been installed on a surface of 4 000 m<sup>2</sup>. Barrisol Acoustics® sheets absorb noise and improve sound comfort in this building of 32 meters height.

### Die Oper von Oslo (Norwegen) mit einer BARRISOL® ACOPERF® Decke

Europäischer Preis für zeitgenössische Architektur 2009: Dieses Gebäude wurde an der Küste des Fjordes gebaut, wo es sich wie ein Eisberg aus dem Boden erhebt. Die Spanndecke Barrisol Acoustics® wurde auf einer Fläche von 4 000 m<sup>2</sup> installiert, um akustische Resonanzen zu absorbieren und so den Raumklang in diesem Gebäude mit 32 m Höhe zu verbessern.

$\alpha_s$	Fréquences - Frequency - Frequenzen (Hz)						Moyenne d'absorption selon / Sound absorption Average according to / Mittlere Schalabsorption gem. ASTM C423-01	Coefficient de réduction du bruit selon / Noise Reduction Coefficient according to / Schallabsorptionskoeffizient gem. ASTM C 423-01	Coefficient d'absorption acoustique mesuré selon / Weighted sound absorption Coefficient according to / Schallabsorptionskoeffizient gemessen nach DIN EN 11654	Classe d'absorption acoustique selon / Sound Absorber class according to / Schalabsorptionsklasse gem. DIN EN 11654
	125	250	500	1000	2000	4000				
ACOPERF® Plenum 100 sans isolant - without insulation ohne Dämmstoff	0,07	0,22	0,69	0,83	0,57	0,61	SAA = 0,60	NRC = 0,58	$\alpha_w = 0,55$	D
ACOPERF® Plenum 100 avec isolant - with insulation mit Dämmstoff: 80 mm	0,20	1,00	1,05	0,95	0,9	0,83	SAA = 1,00	NRC = 0,99	$\alpha_w = 0,95(L)$	A



## A30 MICROACOUSTIC®

■ **MICROACOUSTIC®** sans isolant - without insulation - ohne Dämmstoff

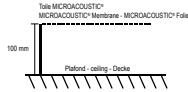

■ **MICROACOUSTIC®** avec isolant - with insulation - mit Dämmstoff

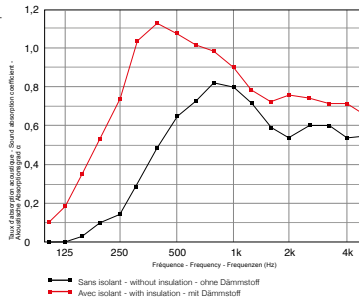
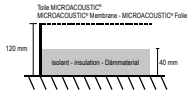

### Caractéristiques - Features - Eigenschaften MICROACOUSTIC® A30



Trous - Holes - Löcher : **300 000/m<sup>2</sup>**  
 Diamètre d'un trou - Hole diameters - Lochdurchmesser : **≈ 0,2 mm**  
 Taux de perforation - Perforation rate - Perforationsrate : **≈ 0,6 %**  
 Épaisseur - Thickness - Dicke : **≈ 0,18 mm**  
 Référence - Reference - Kennung : **A30 + réf. coloris - colour - Farbfref**



Arch. : SNC Lavallin & Bodreau Architecture

Espace Copernic - Groupe Cesbron (France)  
**BARRISOL® MICROACOUSTIC®**  
 Barrisol® permet la réduction de la réverbération des sons dans un espace avec plafond très haut.

*Copernic Hall - Cesbron Group (France)*  
**BARRISOL® MICROACOUSTIC®**  
 Barrisol® offers the possibility to reduce reverberation and improve room acoustic quality in this particular high ceiling place.

*Copernic Halle - Cesbron Firma (Frankreich)*  
**BARRISOL® MICROACOUSTIC®**  
 Mit Barrisol® kann die Resonanz in Räumen mit besonders großer Deckenhöhe verringert werden.

$\alpha_s$	Fréquences - Frequency - Frequenzen (Hz)						Moyenne d'absorption selon / Sound absorption Average according to / Mittlere Schallabsorption gem. ASTM C423-01	Coefficient de réduction du bruit selon / Noise Reduction Coefficient according to / Schallabsorptionskoeffizient gem. ASTM C 423-01	Coefficient d'absorption acoustique mesuré selon / Weighted sound absorption Coefficient according to / Schallabsorptionskoeffizient gemessen nach DIN EN 11654	Classe d'absorption acoustique selon / Sound Absorber class according to / Schallabsorptionsklasse gem. DIN EN 11654
	125	250	500	1000	2000	4000				
MICROACOUSTIC® Plenum 100 sans isolant - without insulation ohne Dämmstoff	0	0,15	0,62	0,80	0,55	0,54	SAA = 0,54	NRC = 0,50	$\alpha_w = 0,50(M)$	D
MICROACOUSTIC® Plenum 120 avec isolant - with insulation mit Dämmstoff: 40 mm	0,18	0,75	1,08	0,90	0,77	0,72	SAA = 0,86	NRC = 0,90	$\alpha_w = 0,80$	B



## A40 MINIPERF®

■ **MINIPERF®** sans isolant - without insulation - ohne Dämmstoff



■ **MINIPERF®** avec isolant - with insulation - mit Dämmstoff

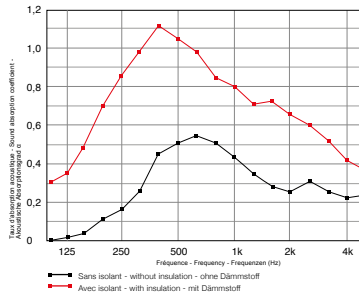

### Caractéristiques - Features - Eigenschaften MINIPERF® A40

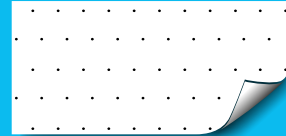

Trous - Holes - Löcher : **30 000/m<sup>2</sup>**  
 Diamètre d'un trou - Hole diameters - Lochdurchmesser : **≈ 0,5 mm**  
 Taux de perforation - Perforation rate - Perforationsrate : **≈ 0,6 %**  
 Épaisseur - Thickness - Dicke : **≈ 0,30 mm**  
 Référence - Reference : **A40 + réf. coloris - colour - Farbfref**



Arch. : Kerez, Moger & Degelo

Musée des Beaux-Arts de Vaduz (Lichtenstein)  
**BARRISOL® LUMIERE® & BARRISOL® MINIPERF®**  
 Barrisol® assure une parfaite mise en valeur des œuvres d'art et un confort acoustique optimale pour ses visiteurs.

*Vaduz Art Museum (Lichtenstein)*  
**BARRISOL® LUMIERE® & BARRISOL® MINIPERF®**  
 Barrisol® enhances the works of art and ensures the acoustic comfort of its visitors.

*Kunstmuseum Vaduz (Lichtenstein)*  
**BARRISOL® LUMIERE® & BARRISOL® MINIPERF®**  
 Durch Barrisol® wird gewährleistet, dass die Kunstobjekte optimal zur Geltung kommen und die Besucher einen optimalen Raumklang vorfinden.

$\alpha_s$	Fréquences - Frequency - Frequenzen (Hz)						Moyenne d'absorption selon / Sound absorption Average according to / Mittlere Schallabsorption gem. ASTM C423-01	Coefficient de réduction du bruit selon / Noise Reduction Coefficient according to / Schallabsorptionskoeffizient gem. ASTM C 423-01	Coefficient d'absorption acoustique mesuré selon / Weighted sound absorption Coefficient according to / Schallabsorptionskoeffizient gemessen nach DIN EN 11654	Classe d'absorption acoustique selon / Sound Absorber class according to / Schallabsorptionsklasse gem. DIN EN 11654
	125	250	500	1000	2000	4000				
MINIPERF® Plenum 100 sans isolant - without insulation ohne Dämmstoff	0,07	0,18	0,51	0,42	0,27	0,23	SAA = 0,35	NRC = 0,30	$\alpha_w = 0,35$	D
MINIPERF® Plenum 100 avec isolant - with insulation mit Dämmstoff: 70 mm	0,35	0,85	1,05	0,80	0,65	0,42	SAA = 0,83	NRC = 0,85	$\alpha_w = 0,65(Lm)$	C





Arch. : Eigen ontwerp - Plafond imprimé - Printed ceiling - Bedruckte Decke

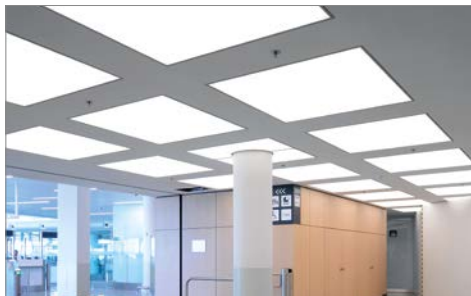

Arch. : Chapman Taylor architects - Plafond lumineux - Luminous ceiling - Leuchtende Decke

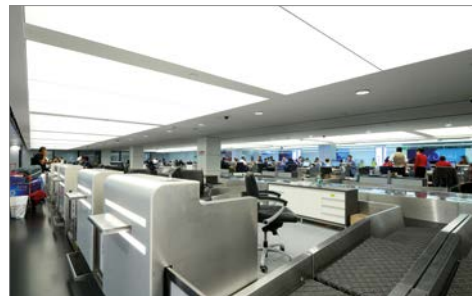

Arch. : Dar Al Handasah - Plafond lumineux - Luminous ceiling - Leuchtende Decke

# Barrisol® Glass Textile solution A2-s1,d0

GTs® non enduit, translucide | GTs® non coated, translucent | GTs® unbeschichtet, transluzent

Classement au feu A2-s1, d0 | Fire classification A2-s1, d0 | Brandklasse A2-s1, d0

Transmission de la lumière 33% Réflexion de la lumière 64% Absorption de la lumière 3%

Light transmission 33% Reflexion rate 64% Light absorption 3% | Lichtverbreitungsgrad 33% Lichtreflexionsgrad 64% Lichtabsorption 3%



Store

Le textile de verre est un matériau qui fait partie de la famille des revêtements muraux et plafonds. Composé de fils de verre extrêmement fins, sa solidité et sa durabilité sont ses caractéristiques les plus appréciées. Nous avons développé notre gamme de plafonds et murs Barrisol GTs® pour répondre aux demandes les plus exigeantes en question de normes de sécurité et santé. Classée A2-s1, d0 (version non enduite) et A2-s2, d0 (version enduite), cette toile est un revêtement mural et plafond incombustible, esthétique et façonnable quasi à l'infini. Elle peut être acoustique, lumineuse, imprimée et est 100% recyclable. Idéale pour les immeubles de grande hauteur, couloirs, voie d'évacuation et tous les lieux nécessitant une esthétique et une sécurité irréprochables.

Glass textile is a material that is part of the family of wall and ceiling coverings. Made of extremely fine glass fibres, its strength and durability are the most appreciated characteristics. We have developed our range of Barrisol GTs® ceilings and walls to meet the most important standards of safety and health.

Classified A2-s1, d0 (non coated version) and A2-s2, d0 (coated version), this sheet is a wall and ceiling covering non-combustible, aesthetic and shapable almost to infinity. It can be acoustic, luminous, printed and is 100% recyclable. Ideal for high-rise buildings, corridors, escape routes and all places requiring aesthetics and impeccable safety.

Glasgewebe ist ein Material, das zur Familie der Wand- und Deckenbekleidungen gehört. Das Gewebe besteht aus extrem feinen Glasdrähten, und zeichnet sich durch eine hohe Stabilität und lange Lebensdauer aus. Die Barrisol GTs® -Decken wurden gemäß unserer hohen Qualitäts-, Sicherheits- und Gesundheitsstandards entwickelt. Klassifiziert als A2-s1, d0 (unbeschichtete Version) und A2-s2, d0 (beschichtete Version) ist die Wand und Deckenbekleidung nahezu unbrennbar, ästhetisch und formbar. Es kann akustisch wirksam, hinterleuchtet oder bedruckt ausgeführt werden und ist 100% recycelbar. Ideal geeignet für ästhetische Anwendungen mit hohen Brandschutzanforderungen wie Flure, Fluchtwege, Versammlungsstätten. Für ein Höchstmaß an Sicherheit.



Designer : Hakan Kiran - Plafond lumineux - Luminous ceiling - Leuchtende Decke



VIDEO



Arch. : Foster + Partners - Plafond acoustique - Acoustic ceiling - Akustikdecke



Arch. : Gabriele Glöcker



Designer : Hakan Kiran



Arch. : Philippe Marragou - Cadres lumineux Barrisol G<sup>Ts</sup>® - Barrisol G<sup>Ts</sup>® luminous frames - Barrisol G<sup>Ts</sup>® Leuchtrahmen

## Les avantages techniques et pratiques

- Toile de grande largeur, idéale pour les grands espaces
- Légère et flexible
- Niveau d'émissions de COV classe A+ (très faibles émissions), le meilleur niveau
- Sans amiante
- LED basse consommation
- Solide, garantie de 10 ans du processus de fabrication
- Résistante à l'humidité
- Respectueuse des normes de sécurité et d'hygiène, des secteurs de l'alimentation et de la restauration
- Possibilité d'intégrer des systèmes d'éclairage, chauffage, climatisation et sonorisation
- Transmission de la lumière en version translucide et absorption de nuisances sonores en version acoustique. Possibilité d'intégrer ces deux qualités sur la même toile (G<sup>Ts</sup>® acoustique lumineuse)
- Isolation thermique légère
- Dalles en cadres auto-portants et ouvrants, facilitant la maintenance

## Technical and practical advantages

- Wide width sheet, ideal for large spaces
- Lightweight and flexible
- VOC emissions class A+ (very low emissions), best rating
- Asbestos free
- Energy-saving LED
- Solid, 10-year warranty on the manufacturing process
- Resistant to moisture
- Respectful of safety and hygiene standards, for food industries and catering
- Possibility of integrating lighting, heating, air conditioning and sound systems
- Transmission of light in translucent version and noise pollution absorption in acoustic version
- Possibility of conferring these two qualities on the same fabric (G<sup>Ts</sup>® acoustic light)
- Light thermal insulation
- Tiles in self-supporting and opening frames to facilitate the maintenance

## Technische und praktische Vorteile

- Bespannungen
- Geringes Gewicht, extrem flexibel
- VOC-Emissionsklasse A+ (sehr niedrige Emissionen), Bestnote
- Asbestfrei
- Geringer Stromverbrauch bei Hinterleuchtung mit LED-Technik
- Solide, 10 Jahre Garantie auf den Herstellungsprozess
- Beständig gegen Feuchtigkeit
- Erfüllt die Hygienestandards der Lebensmittelindustrie und des Caterings
- Möglichkeit der Integration von Beleuchtung, Heizung, Klimaanlage und Soundsystem
- Lichtübertragung durch transluzente Version und akustische Absorption. Beide Eigenschaften durch ein Gewebe realisierbar (G<sup>Ts</sup>® akustisches Licht)
- Wärmedämmeigenschaften
- Flügelrahmen für einfache Wartung





By Rolls-Royce - Plafond lumineux - Luminous ceiling - Leuchtende Decke

## Performances acoustiques | Acoustic performance | Akustische Leistungen

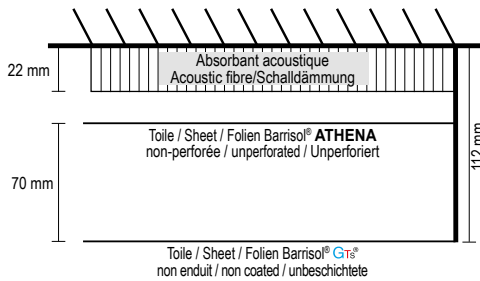

**NRC = 0.80**  
**SAA = 0.78**  
 $\alpha_w = 0.80$   
**class - class - Klasse : B**

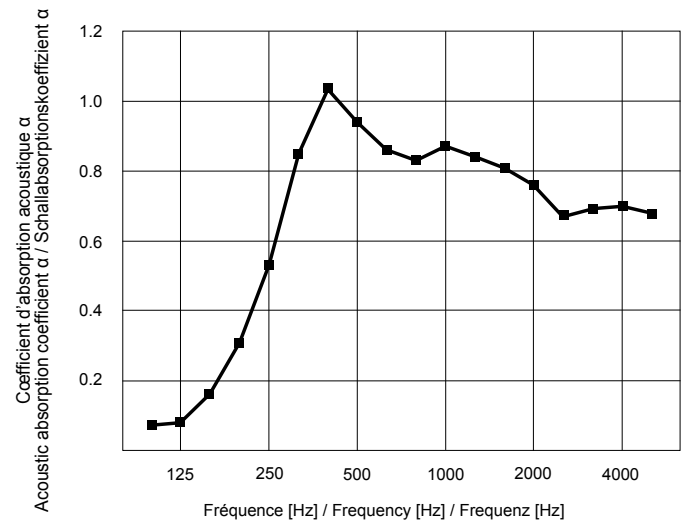



Arch. : DRLW



Design : MFB



Design : SZM



Design : SZM

# Arcolis®

Cadres & baffles acoustiques ■ Acoustic panels & baffles ■ Akustikmodule & -baffeln



La Quille



Gare de Lyon



Exposition  
Ross Lovegrove

Leader mondial des plafonds tendus, récompensé par le Décibel d'Or en 2014 pour ses solutions lumière acoustique, Barrisol® lance les panneaux acoustiques Arcolis®. Fort de son expérience dans le domaine technique de l'acoustique et des solutions pour l'architecture et la décoration, Barrisol® a développé une large gamme de panneaux et baffles acoustiques, à suspendre, à accrocher ou des cloisons amovibles à poser, pour une correction acoustique de tous les espaces publics et privés. Peut-être utilisé, soit en finition Barrisol® soit en finition textile.

World leader in stretch ceilings, awarded the Golden Decibel in 2014 for its acoustic lighting solutions, launches Barrisol® acoustic panels Arcolis®. With his experience in the technical field of acoustics and solutions for architecture and decoration, Barrisol® has developed a wide range of acoustic panels and baffles, to suspend or hang, or removable dividers to ask for a acoustic correction of all public and private spaces. Can be used, either in Barrisol® finish or in textile finish.

Weltmarktführer für Spanndecken, ausgezeichnet mit dem Goldenen Decibel im Jahr 2014 für seine akustische Lichtlösungen, lanciert Barrisol® die Akustikmodule Arcolis®. Mit seiner Erfahrung auf dem technischen Gebiet der Akustik und Lösungen für Architektur und Dekoration, hat Barrisol® eine breite Palette von Akustikmodulen und -baffeln für Decke und Wand entwickelt. Ebenso verschiebbare Trennwände für eine akustische Korrektur aller öffentlichen und privaten Räumen. Diese können entweder mit Barrisol®-Folien oder in Textilausführung bestellt werden.



Design : M. Deyber

VIDEO





Gare de Lyon - Arch. : Arep

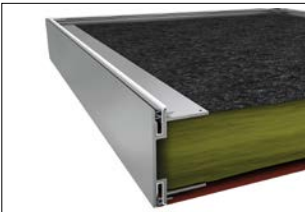

**Finition champs plat aluminium anodisé ou thermolaqué selon couleur RAL**  
Flat edge with anodised aluminium finish or powder coated in a RAL  
**Flachkante aus eloxiertem oder thermolackiertem Aluminium in RAL-Farbe**

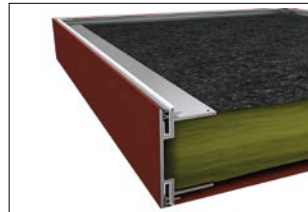

**Finition champs plat habillé**  
Flat edge with covered finish  
**Bezogene Flachkante**



**Finition 2 faces et champ plat aluminium anodisé ou thermolaqué selon couleur RAL**  
Flat edge and two sides with anodised aluminium finish or powder coated in a RAL shade  
**Beidseitig bezogene Flachkante aus eloxiertem oder thermolackiertem Aluminium in RAL-Farbe**

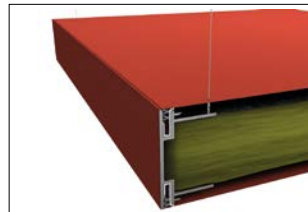

**Finition 2 faces et champ plat habillé**  
Flat edge and two sides with covered finish  
**Beidseitig bezogene Flachkante**



Réalisation : Barrisol® - Intégration lumineuse - Light integration - Integration von Leuchtkörpern





Réalisation : Barrisol® - Cadres blanc au plafond et cadres vert et rouge aux murs  
White ceiling frames and green and red wall frames - Weiße Rahmen an der Decke und grüne und rote Rahmen an den Wänden



Designer : Ross Lovegrove

VIDEO



Musée de l'Impression sur Étoffes - NB



Arch. : LMS Vermeersch - Design : IB Lichtateljee



Arch. : Atelier Jean Nouvel - Cadres imprimés sur-mesure  
Printed frames made-to-measure - Maßgeschneiderte bedruckte Rahmen

# Performances acoustiques

## Acoustic performance | Akustische Leistungen

Mesures selon la norme internationale ISO 11654 et américaine ASTM C 423.

Measurement according to international standard ISO 11654 and US standard ASTM C 423.

Messungen nach der Internationalen Norm ISO 11654 und der US-Norm ASTM C 423.

Panneaux Arcolis® 1 face 1 200 x 600 mm  
posés directement contre le mur ou fixé directement au  
plafond (PV acoustiques disponibles sur demande)

Arcolis® one-sided panels, 1 200 x 600 mm,  
placed directly against the wall or fixed directly to the ceiling  
(acoustics test reports available on request)

Einseitige Arcolis®-Platten 1 200 x 600 mm.  
Direkt an der Wand oder direkt an der Decke befestigt (Proto-  
koll der Akustikmessungen auf Anfrage erhältlich).

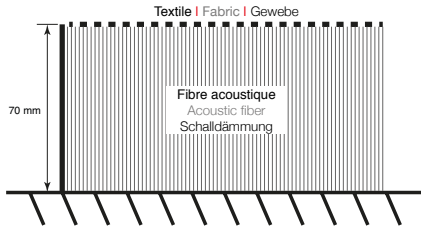

Coefficient d'absorption sonore  $\alpha_p$   
Sound absorption coefficient  $\alpha_p$   
Schallabsorptionskoeffizient  $\alpha_p$

Fréquence Frequency Frequenz (Hz)	$\alpha_p$ [-]
125	0.35
250	0.90
500	1.00
1000	1.00
2000	0.90
4000	0.90

NRC = 0.95  
SAA = 0.98  
 $\alpha_w = 1.0$   
classe - class - Klasse: A

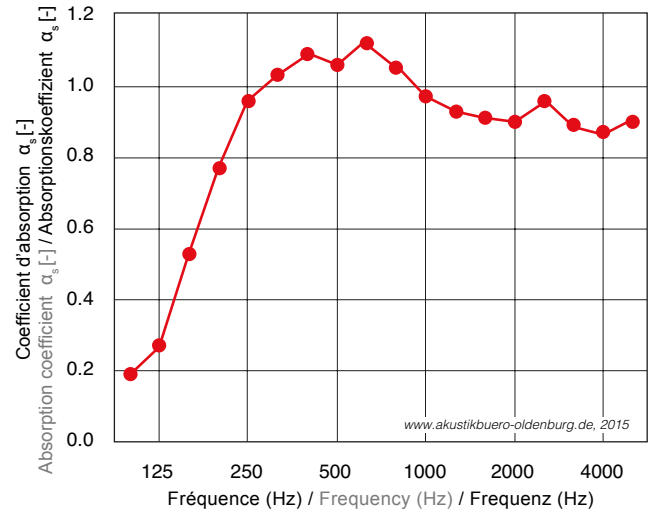

Coefficient d'absorption sonore  $\alpha_s$  selon la norme ASTM C 423

Sound absorption coefficient  $\alpha_s$  according to ASTM C423 | Schallabsorptionskoeffizient  $\alpha_s$  nach ASTM C 423

Fréquence Frequency / Frequenz (Hz)	100	125	160	200	250	315	400	500	630	800	1000	1250	1600	2000	2500	3150	4000	5000
$\alpha_s$ [-]	0.19	0.27	0.53	0.77	0.96	1.03	1.09	1.06	1.12	1.05	0.97	0.93	0.91	0.90	0.96	0.89	0.87	0.90



Arch. : SPC acoustique



Arch. : ASA architekten



Réalisation : Barrisol®



Réalisation : Barrisol®

# MICROSORBER®

Optimisation acoustique & transparence de la lumière | ETFE résistant aux UV  
 Acoustic optimisation & light transparency | ETFE that is resistant to UV  
 Akustische Optimierung & Licht und Transparenz | ETFE, UV-beständig



Neubau  
Verwaltungszentrum



Deutsches Historisches  
Museum Berlin

Microsorber® by Barrisol® est un système d'amélioration du confort acoustique des espaces publics et privés grâce à l'utilisation d'une toile transparente micro-perforée. Au contact de la toile, le mouvement d'air induit par une source sonore est partiellement absorbé grâce à la micro-perforation, cassant ainsi l'effet de réverbération. La réverbération et le niveau sonore sont réduits de manière significative. Microsorber® by Barrisol® est résistant aux UV et peut être imprimé.

Microsorber® by Barrisol® is an innovative sound comfort optimizer reducing sound reflexion thanks to the use of a micro perforated foil. As soon as sound waves strike the microperforated surface, a physical reaction takes place: sound energy is converted into energy through the friction arising at the hole edges reducing reverberation times and sound levels at the same time. Reverberation times and sound levels are reduced significantly. Microsorber® by Barrisol® is UV resistant and can be printed.

Microsorber® by Barrisol® ist ein System zur Verbesserung des akustischen Komforts öffentlicher und privater Räume dank der Verwendung eines mikroperforierten, transparenten Gewebes. Wenn eine Luftschwingung, die durch eine Schallquelle ausgelöst wird, mit dem Gewebe in Berührung kommt, wird sie dank der Perforationen teilweise absorbiert, sodass der Nachhalleffekt unterbunden wird. Nachhall und Lärmpegel werden deutlich verringert. Microsorber® by Barrisol® ist UV-resistent und kann bedruckt werden.

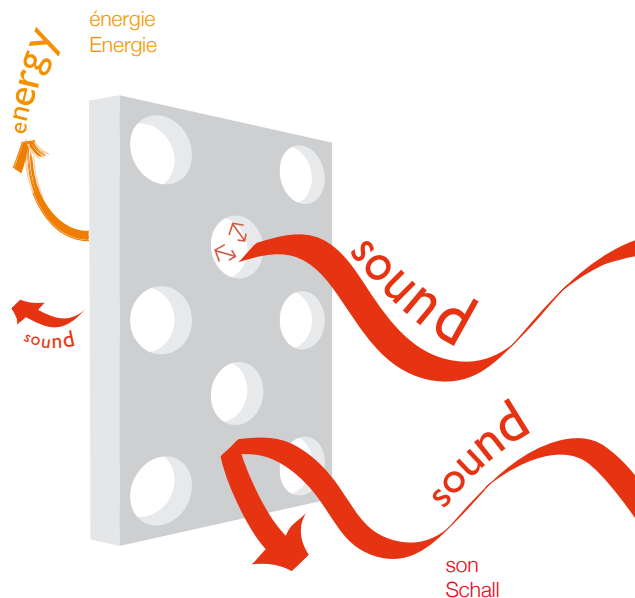





Arch. : Ingenhoven architects gmbh



Arch. : I.M. Pei



Réalisation : Barrisol®



Arch. : Kauffmann Theilig & Partner



Réalisation : Barrisol®



Arch. : Behnisch und Partner



Arch. : DD Architektur

## Microsorber® imprimé | Printed Microsorber® | Microsorber® bedruckt



Arch. : Moatti et Rivière

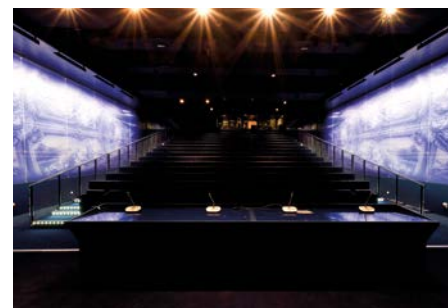



Performances acoustiques | Acoustic performance | Absorptionswerte

**BARRISOL® MICROSORBER®**

**Toile simple / Single-layered / Einlagig**

Épaisseur - thickness - Foliendicke: 0.1 mm  
 Diamètre d'un trou - Hole diameter - Lochdurchmesser: 0.2 mm  
 Espace entre 2 trous - Hole spacing - Lochabstand: 2.0 mm  
 Poids - weight - Gewicht: 0.14 kg / m<sup>2</sup>

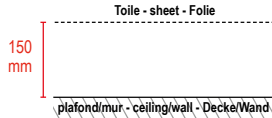

NRC = 0.50  
 SAA = 0.51  
 $\alpha_w = 0.55$   
 classe - class - Klasse : D

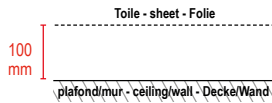
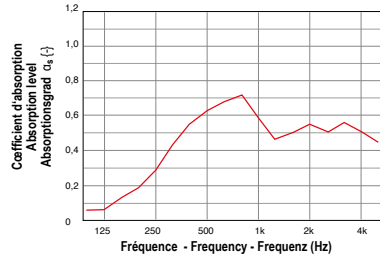

NRC = 0.45  
 SAA = 0.46  
 $\alpha_w = 0.45$  (M)  
 classe - class - Klasse : D

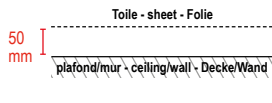
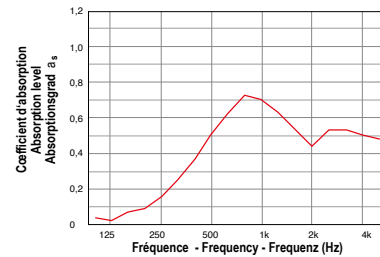

NRC = 0.45  
 SAA = 0.43  
 $\alpha_w = 0.35$  (MH)  
 classe - class - Klasse : D

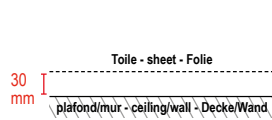
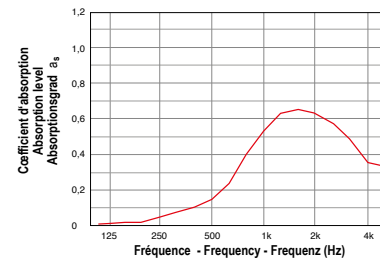

NRC = 0.25  
 SAA = 0.25  
 $\alpha_w = 0.15$  (H)  
 classe - class - Klasse : E

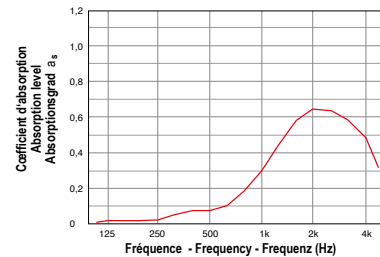

**BARRISOL® MICROSORBER®**

**Double toile / Double-layered / Zweilagig**

Épaisseur - thickness - Foliendicke: 0.1 mm  
 Diamètre d'un trou - Hole diameter - Lochdurchmesser: 0.2 mm  
 Espace entre 2 trous - Hole spacing - Lochabstand: 2.0 mm  
 Poids - weight - Gewicht: 0.14 kg / m<sup>2</sup>

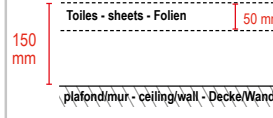

NRC = 0.65  
 SAA = 0.67  
 $\alpha_w = 0.70$   
 classe - class - Klasse : C

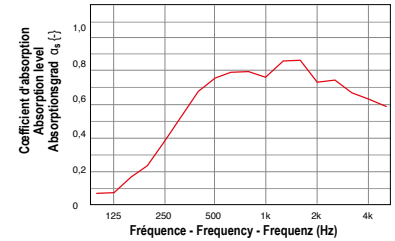

NRC = 0.65  
 SAA = 0.66  
 $\alpha_w = 0.65$   
 classe - class - Klasse : C

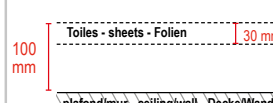
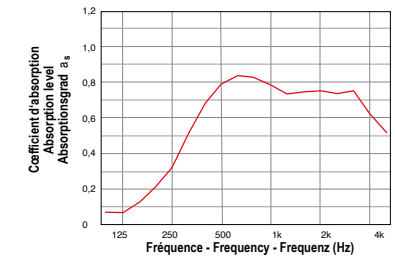

NRC = 0.70  
 SAA = 0.67  
 $\alpha_w = 0.60$  (MH)  
 classe - class - Klasse : C

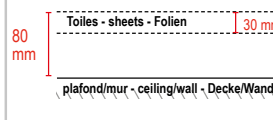
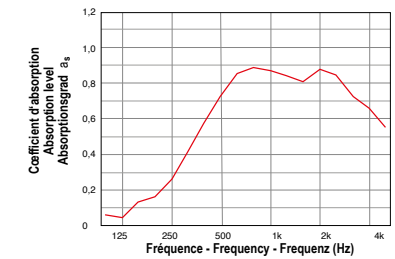

NRC = 0.65  
 SAA = 0.63  
 $\alpha_w = 0.50$  (MH)  
 classe - class - Klasse : D

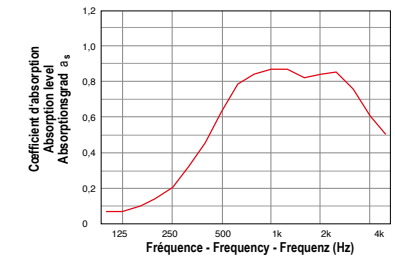





Arch. : Jean-François Brodbeck  
Miroir argent - Silver mirror - Spiegel Silber



Design : JMS - US  
Miroir argent - Silver mirror - Spiegel Silber



Musée de l'Impression sur Étoffes  
Miroir argent - Silver mirror - Spiegel Silber



Réalisation : Barrisol®  
Miroir or - Gold mirror - Spiegel Gold



# Barrisol® Mirror®

Solutions miroir ■ Mirror solutions ■ Spiegel Lösungen



**2015**  
TOP DESIGN  
AWARD



Audi Dogus mirror



Christoffe mirror



Krucza 16/2



Private Office



Forum Gdansk



Stand Ross Lovegrove



Havas HIX



Restaurant Le Buerehiesel

Grâce à ses qualités exceptionnelles, Barrisol Mirror® combine la puissance réfléchissante d'un miroir et les caractéristiques des toiles tendues Barrisol®. Imprimée ou rétro éclairée, la toile Barrisol Mirror® allée au système exclusif de micro-perforations, améliore le confort acoustique de tous les espaces. Disponible en diverses finitions : Argent, Or, Cuivre, Cuivre moiré, Étain moiré, Noir, Barrisol Mirror® est également disponible en version acoustique, imprimée et s'adapte très bien aux formes 3D.

With its exceptional qualities, Barrisol Mirror® mixes the reflective capacity of a mirror and the characteristics of Barrisol® stretched sheets. Whether printed or backlit, Barrisol Mirror®, combined with an exclusive system of micro-perforations, enhance the acoustic comfort of any space. Available in various finishes: Silver, Gold, Copper, Moire Copper, Moire Tin, Black, Barrisol Mirror® is also available in acoustic, printed version and adapts very well to 3D shapes.

Dank seiner außergewöhnlichen Qualität vereint Barrisol Mirror® in sich die Reflexionsleistung eines Spiegels und die Eigenschaften der Spannfolie von Barrisol®. Ob Sie sich für die bedruckte oder die hinterleuchtete Version entscheiden, in Kombination mit dem exklusiven Perforationssystem verbessert Barrisol Mirror® den akustischen Komfort in Räumen aller Art. Unterschiedliche Ausführungen stehen zur Auswahl: Silber, Gold, Kupfer, Kupfer Moiré, Zinn Moiré. Barrisol Mirror® ist ebenfalls in Akustikversion und bedruckt erhältlich und fügt sich einwandfrei in 3D-Projekte ein.



Arch. : Cabinet Saguez et Partners  
Miroir argent - Silver mirror - Spiegel Silber



Designer : Boytorun Mimarlık - Miroir noir - Black mirror - Spiegel Schwarz



## A15 NANOPERF®



Perforations  
perforation  
Perforationen

Caractéristiques - features - Merkmale

Trous - holes - Löcher : **500 000/m²**

Diamètre d'un trou - holes diameters

Lochdurchmesser : = **0,1 mm**

Taux de perforation - perforation rate

Perforationrate : = **1 %**

Epaisseur - thickness - Dicke : = **0,18 mm**

Référence - reference - Referenz :

**A15 + réf. coloris - colour - Farbfref**

■ **NANOPERF®** installée à 130 mm du plafond original  
installed with 130 mm cavity - installiert bei 130 mm Abstand

Toile NANOPERF®  
NANOPERF® Membrane - NANOPERF® Folie

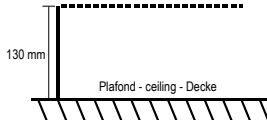

**NRC: 0.60**  
**SAA: 0.62**  
 **$\alpha_w$ : 0.65**

classe - class - Klasse: **C**

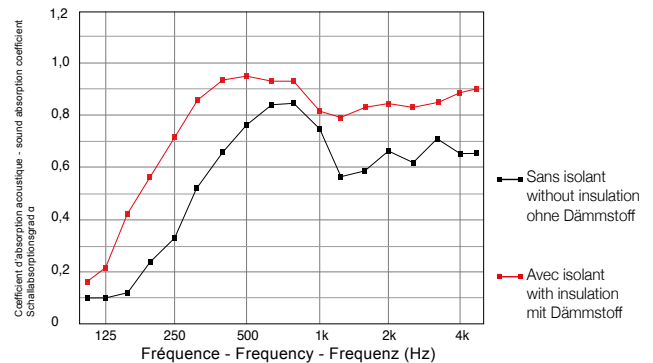

■ **NANOPERF®** avec isolant - with insulation - mit Dämmmaterial

Toile NANOPERF®  
NANOPERF® Membrane - NANOPERF® Folie

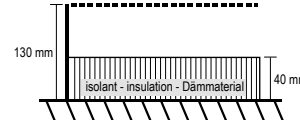

**NRC: 0.85**  
**SAA: 0.83**  
 **$\alpha_w$ : 0.90**

classe - class - Klasse: **A**



Miroir Argent | Silver Mirror | Spiegel Silber



Arch. : Hannes Peer



Arch. : Gensler



Arch. : Dickson interior Design





Arch. : Marcin Gnich

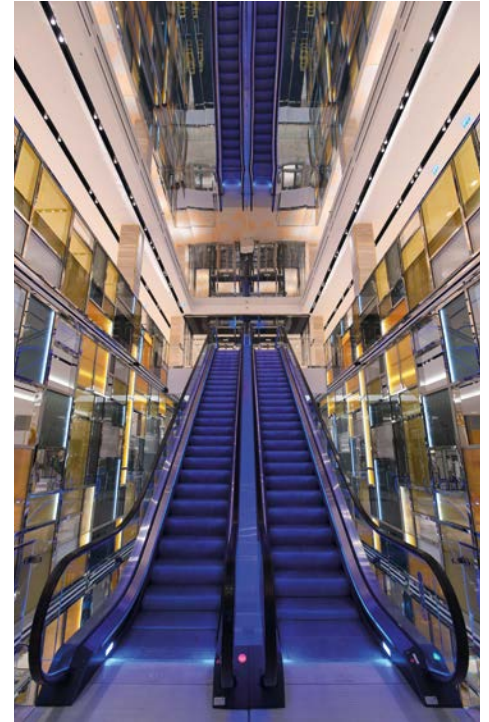

Ing. : AEB Arab Engineering Bureau - Design Int. : Four IV



Arch. : Durmuş Dilekçi



Arch. : Lemay & Escobar Design by Lemay



Arch. : Acer Architectes

## Miroir Or | Gold Mirror | Spiegel Gold



Designer : Devrim TURAN



Réalisation : Barrisol®





Arch. : Inma Rabano

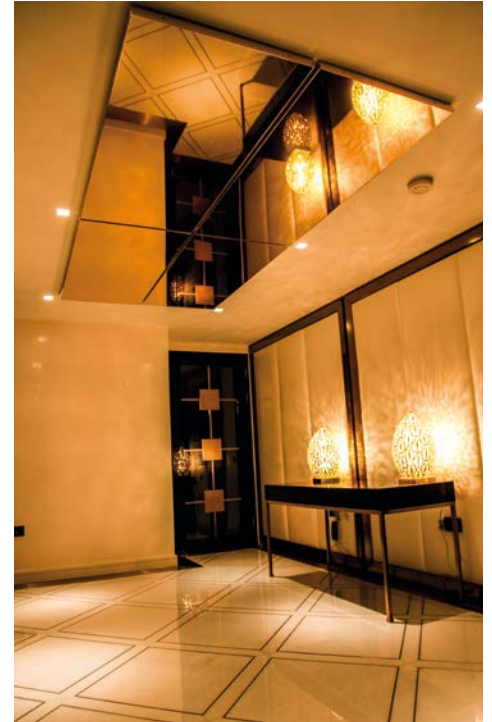

Réalisation : Barrisol®



Réalisation : Barrisol Finland®



Arch. : Gilles Guillot



Arch. : Design studio : 2PM Piotr Musiałowski



Miroir Noir | Black Mirror | Spiegel Schwarz



Arch. : Sekmen partners

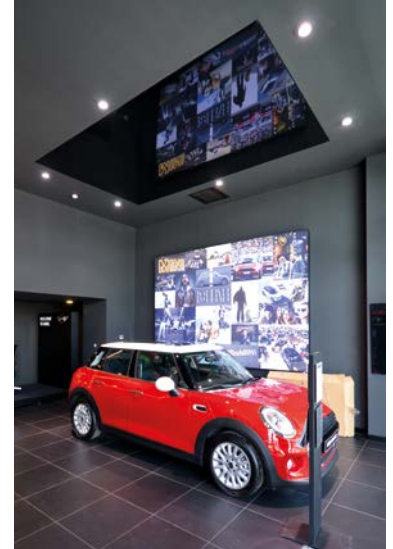

Design : Dikmen Tayfur

Le miroir dans tous ses états : cuivre, étain moiré, or  
The mirror in all its forms: copper, tin moiré, gold  
Der Spiegel in den Oberflächen: Kupfer, Zinn Moire, Gold



Arch. : Alberto Castillo Nakoura - Cúbica Estudio  
Miroir cuivré, miroir étain moiré, miroir or - Copper mirror  
Tin moiré mirror, Gold mirror - Spiegel Kupfern, Spiegel Zin Moire,  
Spiegel Gold

# Miroir 3D | 3D Mirror | 3D Spiegel



VIDEO



Arch. : Sud Architecte



VIDEO



Designer : Ross Lovegrove for Barrisol®



Arch. : Estudio Botner Pecina



Miroir design | Design mirror | Design-Spiegel

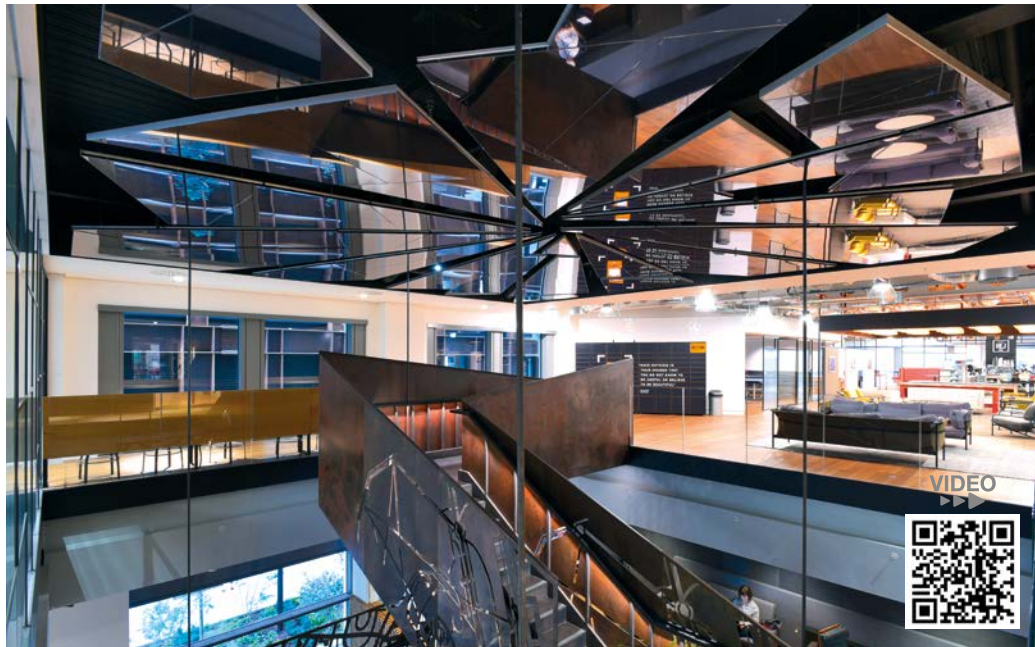

Arch. : MCM Architecture



Arch. : Steven Laab



Arch. : Ann Snauwaert



Comédie musicale - 42<sup>nd</sup> Street - Musical comedy - 42<sup>nd</sup> Street - Musical - 42<sup>nd</sup> Street  
Réalisation : Barrisol® - Welch





Miroir imprimé | Printed mirror | Bedruckter Spiegel



VIDEO



Miroir imprimé avec paysage - Mirror printed with landscape - Bedruckter Spiegel mit Landschaft Arch. : Guy Walter - Design: SZM



Réalisation : Barrisol®  
Miroir imprimé finition béton - Concrete-finish printed mirror - Bedruckter Spiegel mit Beton-Finish



Réalisation : Barrisol®  
Miroir imprimé avec personnage - Mirror printed with a character - Bedruckter Spiegel mit Person



Arch. : De Schepper E.C.



Arch. : Nagui Sabet

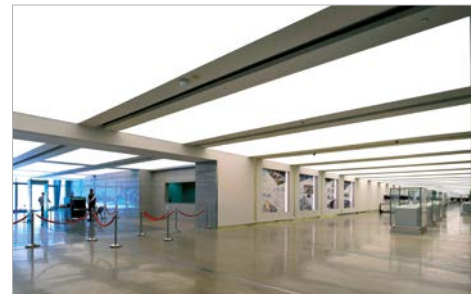

Arch. : SSH International, Architects



# Barrisol®

## Lumière Acoustique® Acoustic Light® Das akustische Licht®



Solutions acoustiques pour la lumière ■ Luminous acoustic solutions ■ Leuchtende akustische Lösungen



Bell Yorkdale



Beltherm



Next Level Mall



Office

Souhaitée depuis de nombreuses années et attendues par les architectes et acousticiens, la lumière acoustique devient enfin réalité. La solution Barrisol Lumière Acoustique® est le fruit de plusieurs années de recherche et développement. Barrisol® est parvenu à rendre acoustique un matériau lumineux tout en conservant son esthétique et en lui conférant des coefficients d'absorption acoustique très performants :  $\alpha_w$  de 0,55 à 0,80.

La solution Barrisol Lumière Acoustique® vient donc aujourd'hui à point nommé pour compléter la gamme de plafonds lumineux proposée depuis de nombreuses années par Barrisol®.

Acousticians and architects have been expecting it for years. Acoustic light has now become a reality. The Acoustic Light® by Barrisol® is the result of many years of research and development. The luminous material has become acoustical, retained its attractive appearance and has excellent sound absorption coefficients: NRC Ratings between 0.55 and 0.80.

The Acoustic Light® by Barrisol® solution now appropriately completes the range of luminous ceilings Barrisol® has offered for many years.

Akustiker und Architekten warten seit Jahren darauf. Akustisches Licht ist jetzt Realität geworden.

Die akustische Lichtwand® von Barrisol® ist das Ergebnis jahrelanger Forschung und Entwicklung. Leuchtendes Material ist akustisch wirksam geworden, es behält seine einzigartige Erscheinung bei gleichzeitig ausgezeichneter akustischer Absorptionswerte:  $\alpha_w$  de 0.55 à 0.80. Die akustische Lichtwand® ergänzt nun unsere Palette von innovativen Barrisol®-Lösungen.

▶▶▶▶ **A15 NANOPERF® SANS ISOLANT**  
WITHOUT INSULATION - OHNE ISOLIERUNG



▶▶▶▶ **A15 NANOPERF® AVEC ISOLANT**  
AVEC ISOLANT - MIT ISOLIERUNG



**Caractéristiques features - Merkmale**



Trous - holes - Löcher: **500 000/m²**  
Diamètre d'un trou - holes diameters  
Lochdurchmesser: **≈ 0.1 mm**  
Taux de perforation - perforation rate  
Perforationrate: **≈ 1 %**  
Épaisseur - thickness - Dicke: **≈ 0.18 mm**  
Référence - reference - Referenz:  
**A15 + coloris - ref. colour - Farbfref**

**NANOPERF® sans isolant**  
without insulation / ohne Isolierung

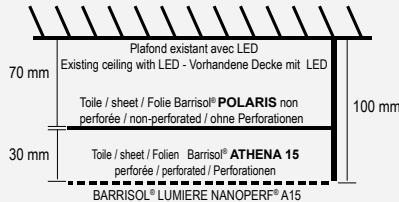

**NANOPERF® avec isolant**  
with insulation / mit Isolierung

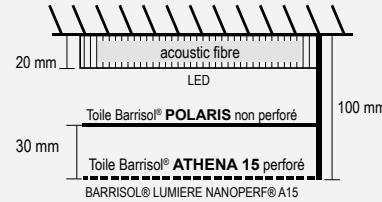

**Caractéristiques features - Merkmale**



Trous - holes - Löcher: **500 000/m²**  
Diamètre d'un trou - holes diameters  
Lochdurchmesser: **≈ 0.1 mm**  
Taux de perforation - perforation rate  
Perforationrate: **≈ 1 %**  
Épaisseur - thickness - Dicke: **≈ 0.18 mm**  
Référence - reference - Referenz:  
**A15 + coloris - ref. colour - Farbfref**

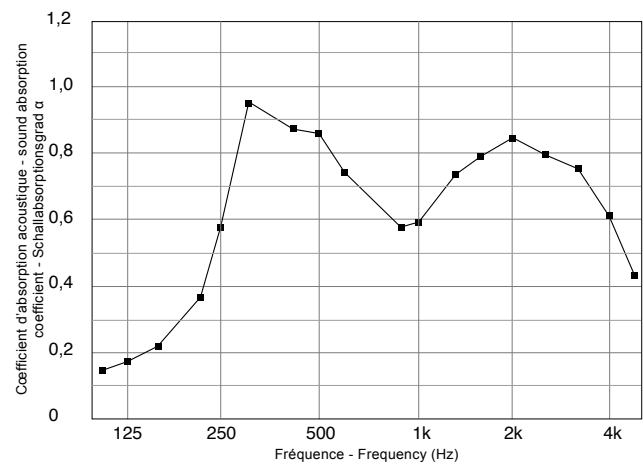
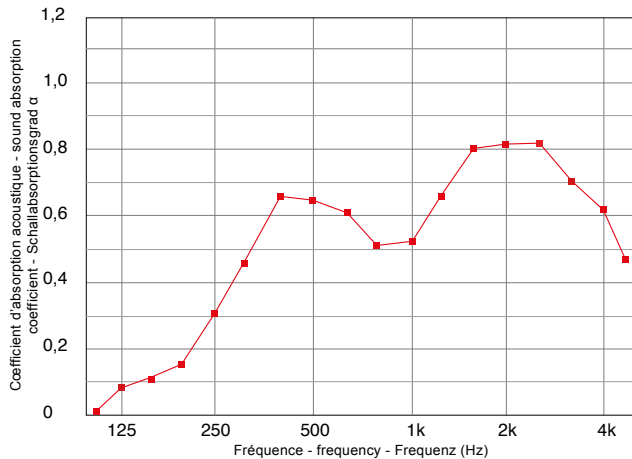

$\alpha_s$	Fréquences - Frequency - Frequenzen (Hz)						Moyenne d'absorption selon / Sound absorption Average according to / Mittlere Schallabsorption gem. ASTM C423-01	Coefficient de réduction du bruit selon / Noise Reduction Coefficient according to / Schallabsorptionskoeffizient gem. ASTM C 423-01	Coefficient d'absorption acoustique mesuré selon / Weighted sound absorption Coefficient according to / Schallabsorptionskoeffizient gemessen nach DIN EN 11654	Classe d'absorption acoustique selon / Sound Absorber class according to / Schallabsorptionsklasse gem. DIN EN 11654
	125	250	500	1000	2000	4000				
NANOPERF® Plenum 100 mm avec isolant - with insulation mit Dämmstoff: 20 mm	0.15	0.60	0.80	0.60	0.80	0.60	SAA = 0.72	NRC = 0.70	$\alpha_w = 0.70(H)$	C
NANOPERF® Plenum 100 mm sans isolant - without insulation ohne Dämmstoff	0.05	0.30	0.65	0.55	0.80	0.60	SAA = 0.58	NRC = 0.55	$\alpha_w = 0.55(H)$	D



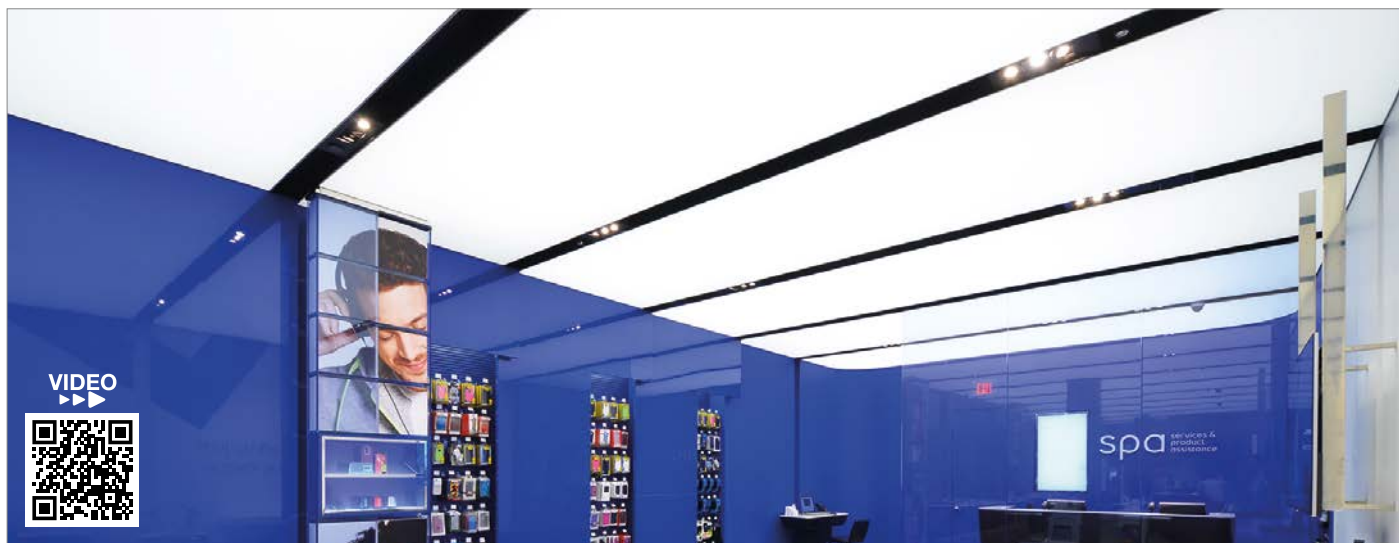

Arch. : Burdiflek

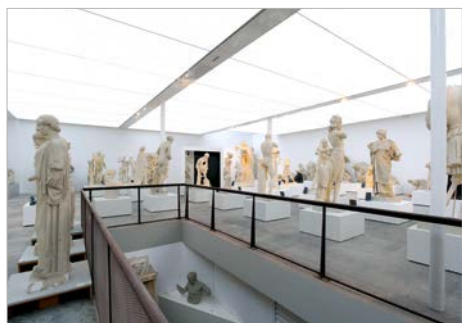

Arch. : Agence d'architecture Nicolas C. Guillot  
LED Périphérique - Peripheral LEDs - LED-Deckenaufsatz



Arch. : Reichardt Ferreux Architectes



Arch. : AHMM

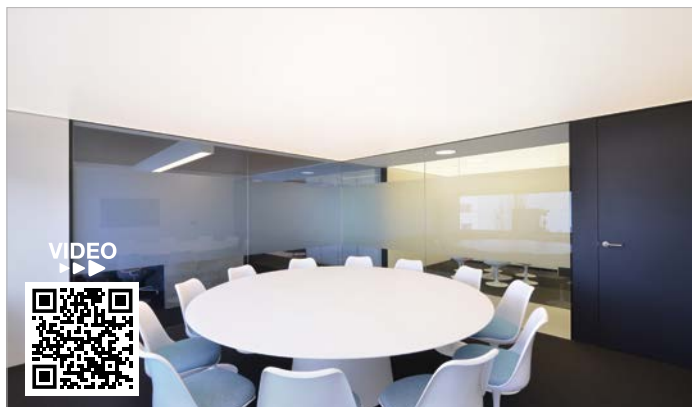

Arch. : Lineos Ontwerp bureau



Arch. : Brigitte Weber

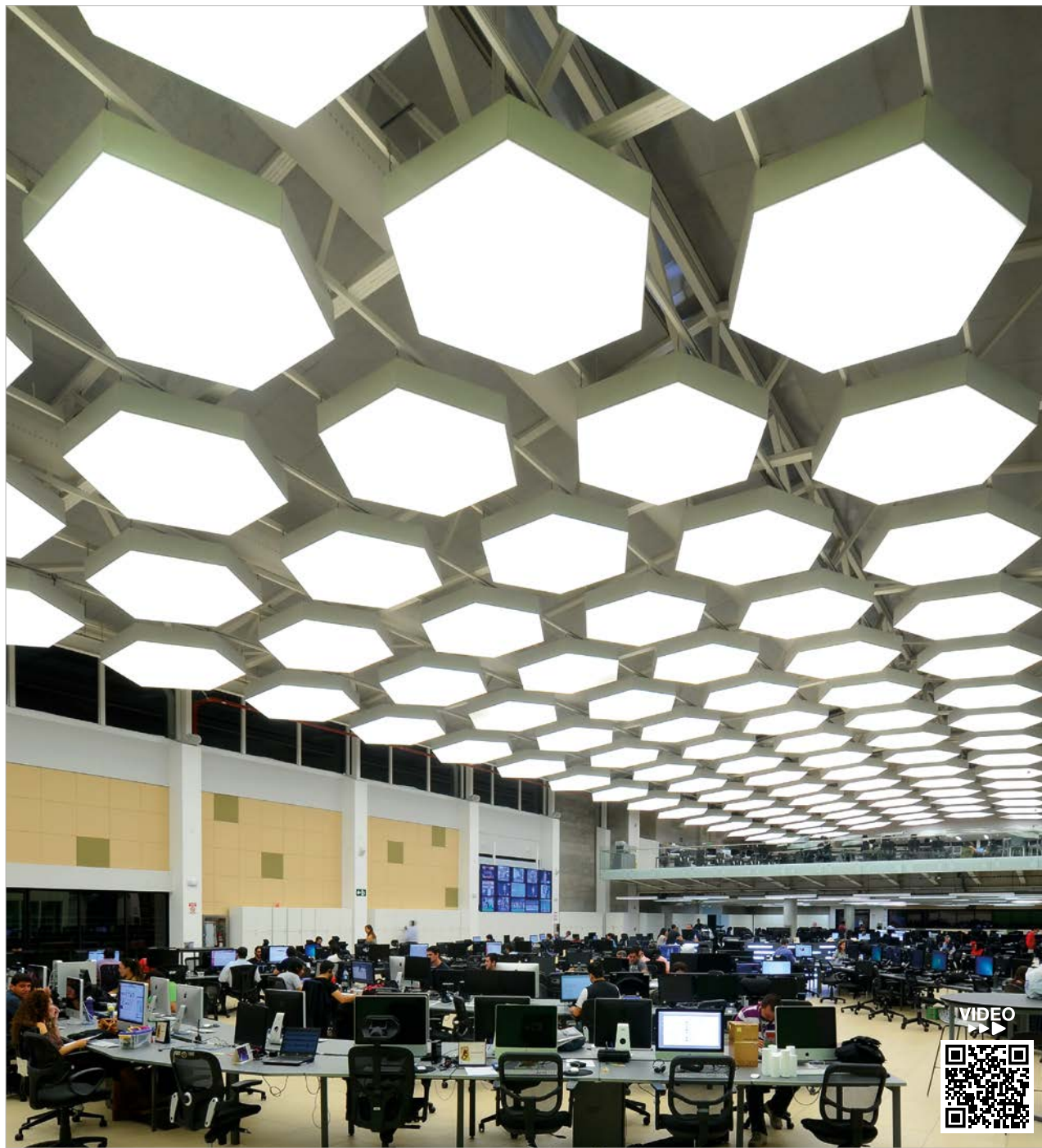

Arch. : Parq Projecto Arquitectura





Designer : Arnaud Klein



Arch. : RSP Interiors Pte Ltd



Arch. : Interior Design Co Twee, Antwerpen



Arch. : Tolga Çokşenim

# Barrisol® Lumière®

Solutions pour la lumière ▪ Lighting solutions ▪ Lichtlösungen



Musée Alpha Roméo



GSA Europe  
Galileo



Holt Rentrifew  
Square One



Akzo Nobel



Hotel Mella Benidorm

## Barrisol® Lumière® invite la lumière à l'intérieur.

Les sources lumineuses sont placées au-dessus des toiles Barrisol® translucides qui diffusent la lumière d'une manière douce et uniforme sur l'ensemble de l'espace à vivre. Grâce aux systèmes d'éclairage (fluos, LEDs, etc.) et aux différents degrés de diffusion de la lumière des gammes Les Translucides® et Les Xtrem®, les plafonds Barrisol® Lumière® offrent une multitude d'ambiances lumineuses (lumière diffuse, vive, colorée, naturelle, etc.). Barrisol® Lumière® peut prendre la forme d'un chemin lumineux, d'un plafond, d'une cloison ou encore d'une forme en 3D.

Les toiles Barrisol® Lumière® peuvent aussi être acoustiques, micro-perforées et imprimées.

## Barrisol® Lumière® invites light into interior spaces.

Light sources are placed above the translucent Barrisol® membrane which diffuses the light in a sweet homogenous way for the entire interior space. Thanks to the various light sources available (fluorescent tubes, LEDs etc.) in conjunction with the various diffusion characteristics of the Barrisol® translucent membranes, a multitude of lighting effects and moods are possible (bright, diffuse, colored etc.) Barrisol® Lumière® Translucid® and Xtrem® can be used for ceilings, walls or any form or 3D shape. These membranes can also be micro-perforated and printed.

## Barrisol® Lumière® bringt Licht ins Haus.

Die Lichtquellen werden unter unter transluzenten Barrisol® Decken angebracht, die das Licht sanft und gleichmäßig über den gesamten Raum verteilen. Durch den Einsatz von verschiedenen Beleuchtungssystemen (Leuchtstofflampen, LEDs) und die unterschiedlichen Grade der Lichtverteilung der Produkte Les Translucides® und Les Xtrem®, schaffen die Barrisol® Lumière® Decken unzählige Lichtstimmungen (diffuses, helles, farbiges oder natürliches Licht usw.). Decken aus Barrisol® Lumière® können die Form eines Leuchtbandes, einer Decke, einer Zwischenwand oder auch eine dreidimensionale Form annehmen.

Die Barrisol® Lumière® Decken können auch schalldämmend, mikroperforiert und bedruckt sein.



VIDEO



Arch. : Benedetto Camera





Arch. : Martin Perlik - AP Studio Perlik & Krytl



Arch. : IBI Group

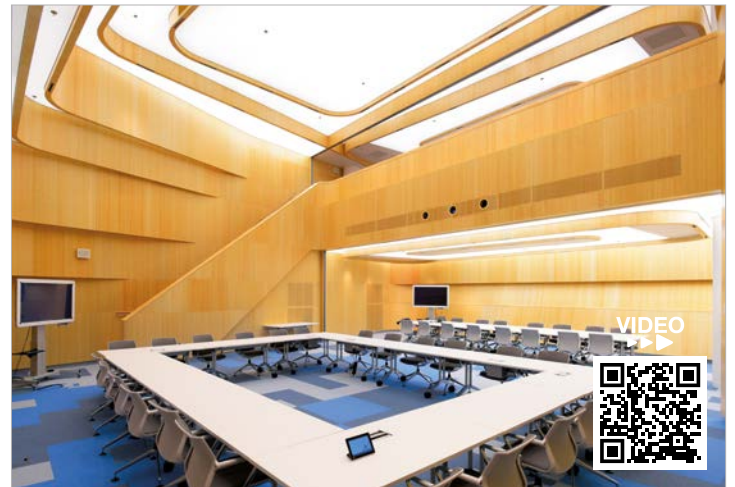

Arch. : Group A

## Éclairage par LED périphérique Lit by means of peripheral LEDs | Beleuchtung durch seitliche LED Platzierung



Arch. : Ciro Mariani



Arch. : Danilo Mikić



VIDEO



Arch. : Curvics Arquitectura + Suitel Design



Arch. : Bleu Cube Architecture

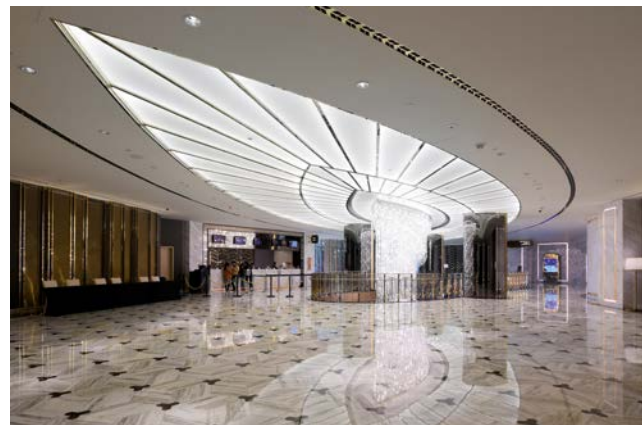

Arch. : Leigh & Orange



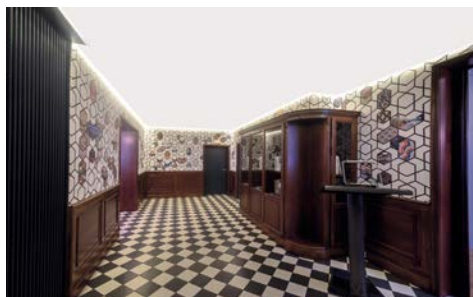

Mur - Wall - Wände : SZM  
Plafond - Ceiling - Decken : Barrisol®



Arch. : Marcin Gnich

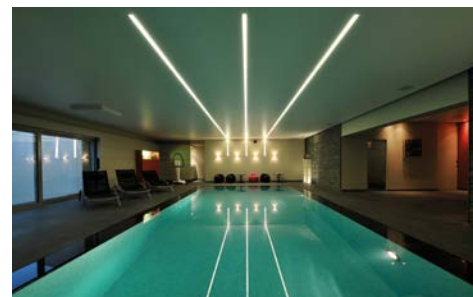

Arch. : Jan Anseeuw

# Barrisol® Light Lines®



Private House



Mosquée de Saint-Louis

Le système **Light Lines®** est un moyen complémentaire de rendre le séparateur esthétique et lumineux. Il s'adapte à tous les styles et gammes **Barrisol®** : Les Reflets Laqués®, Les Reflets Satinés®, Les Recyclés®, Les Mats Tradition®, Les Daims Ambiance®, Les Effets Matière®, Les Collections Matière®, Creadesign®, Barrisol Biosourcée®, Les Acoustics®, Les Xtrem®, Les Métal®, Les Translucides®, Les Effets Lumière®, Print your Mind®, Barrisol Mirror®, Les Perforés®.

The **Light Lines®** system is a complementary way to make the separator aesthetic and luminous. It adapts to all **Barrisol®** styles and ranges: Les Reflets Laqués®, Les Reflets Satinés®, Les Recyclés®, Les Mats Tradition®, Les Daims Ambiance®, Les Effets Matière®, Les Collections Matière®, Creadesign®, Barrisol Biosourcée®, Les Acoustics®, Les Xtrem®, Les Métal®, Les Translucides®, Les Effets Lumière®, Print your Mind®, Barrisol Mirror®, Les Perforés®.

Die **Light Lines®** sind eine ergänzende Möglichkeit, den Separator ästhetisch und leuchtend zu machen. Es passt sich allen **Barrisol®** Stilen und Bereichen an: Les Reflets Laqués®, Les Reflets Satinés®, Les Recyclés®, Les Mats Tradition®, Les Daims Ambiance®, Les Effets Matière®, Les Collections Matière®, Creadesign®, Barrisol Biosourcée®, Les Acoustics®, Les Xtrem®, Les Métal®, Les Translucides®, Les Effets Lumière®, Print your Mind®, Barrisol Mirror®, Les Perforés®.



Arch. : Lineos Ontwerp bureau – Chris Vantornout

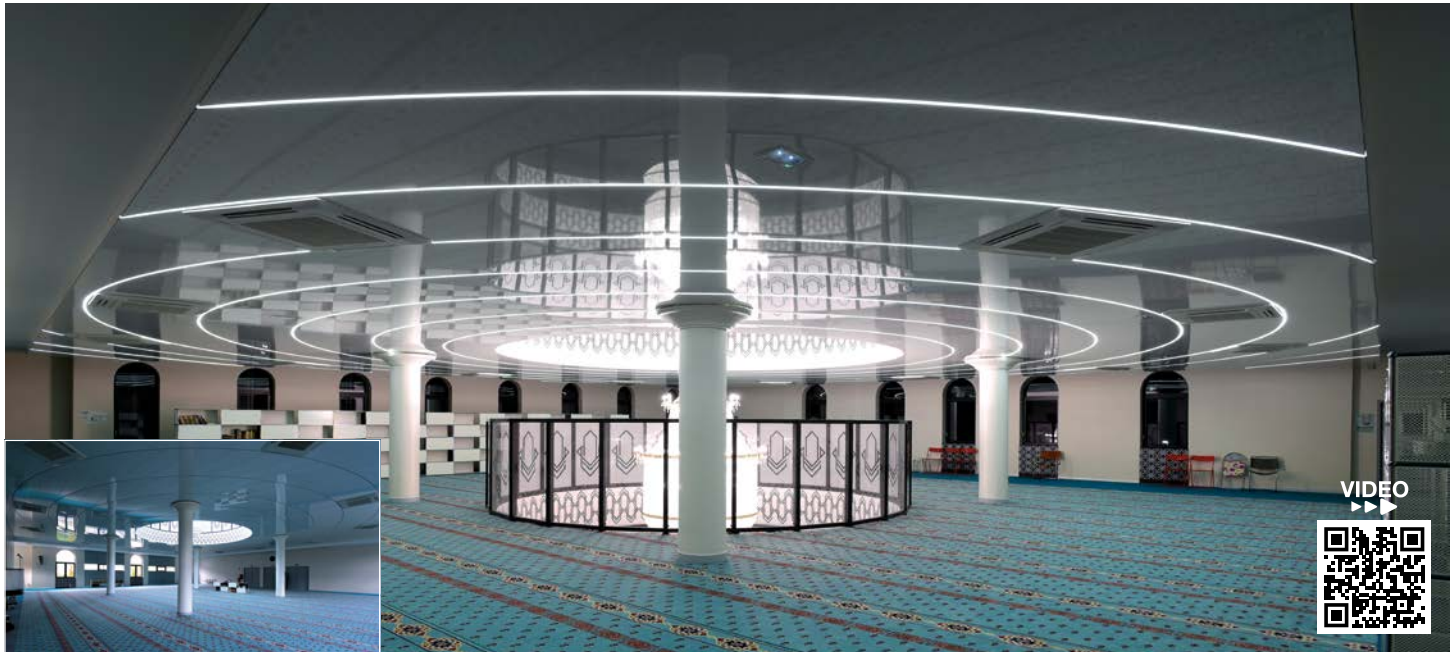

Arch. : Arcanes Minotaure Roland Spitz

<p><b>Ref. : BS 350/13</b> Lisse aluminium pour éclairage LED périphérique Aluminium track for perimeter LED lighting Wandanschlussleiste zur Aufnahme von LED-Beleuchtung</p>		
<p><b>Ministar®</b> <b>Réf. : BMS 340/14</b> Lisse aluminium pour éclairage LED périphérique Aluminium track for perimeter LED lighting Wandanschlussleiste zur Aufnahme von LED-Beleuchtung</p>		
<p><b>•Ministar®</b> <b>Réf. : BMS 365/40</b> Séparateur LED pour cercle et forme 3D LED separator for circle and 3D shape Trennschiene für kreisrunde und 3D-Formen</p>		
<p><b>Ministar®</b> <b>Réf. : BMS 365/50</b> Séparateur LED mur et plafond LED wall and ceiling separator Trennschiene für Wand- und Deckenanschluss</p>		

\*Suivant le profilé, qu'il soit incliné ou non, la couleur du textile va influencer la couleur de la lumière -  
Depending on the profile, either inclined or not, the colour of the textile will influence the colour of the light  
- Abhängig vom Profil, abgesehen oder nicht, beeinflusst die Farbe der Spannfolie die Lichtfarbe



Arch. : Edo Kadribegovi

# Barrisol®

## Bandes lumineuses

### Light strips ■ Lichtstreifen

Bandes lumineuses de toutes largeurs et de toutes longueurs  
Light strips in all widths and lengths ■ Lichtstreifen aller Größen und Längen



Wedding salon  
Ruza Mostar



Growthpoint



Place Québec

Barrisol®, par ses caractéristiques uniques, permet de réaliser des bandes lumineuses de toutes formes et de toutes largeurs. Barrisol® réalise des prouesses impossibles avec un autre type de matériau grâce à un procédé breveté. Il peut également être imprimé. Barrisol® réalise les effets lumineux dont vous avez toujours rêvé, avec une parfaite et homogène diffusion de la lumière.

Barrisol®, through its unique features, is able to create a light strips of all shapes and lengths. Thanks to its patented process, Barrisol® is able to create unbelievable achievements, unfeasible with any other material.

Barrisol® creates the luminous effects you have always dreamed of, with a perfect and homogeneous light diffusion.

Dank seiner einzigartigen Eigenschaften ermöglicht Barrisol® die Installation von Lichtstreifen jeder Form und jeder Breite. Mithilfe einer anderen Werkstoffart und dank eines patentierten Verfahrens vollbringt Barrisol® Meisterleistungen, die Ihre Vorstellungskraft übertreffen. Es kann sogar bedruckt werden.

Barrisol® erzielt die Lichteffekte, von denen Sie immer geträumt haben, mit einer perfekten und gleichmäßigen Lichtstreuung.



Arch. : Alia Alghunaim - Design Manager : Mabanee Company S.A.K





VIDEO



Arch. : Edo Kadribegovi



Arch. : HMONP



Arch. : HOK



Arch. : Daniel Libeskind AG



VIDEO



Arch. : Guy Steenkamp



VIDEO



Arch. : Atelier 21



Design : Lina Gener &amp; Antonio Calvo / ACS Ibiza

# Barrisol® Lumière Color®

Variation de couleur ■ Lighting color variation ■ Lichtfarbvariation



Wedding Viktorija



Vasaa University



Hotel Spa Arkamów



Brisbane City Hall

Avec Barrisol Lumière Color®, tous types d'ambiances lumineuses deviennent possibles grâce à la variation de lumière et aux changements de couleurs. Les systèmes d'éclairage spécifiques placés au-dessus des toiles Barrisol® translucides rythment, animent et mettent en valeur l'espace.

Barrisol Lumière Color® allows a multitude of moods and ambiances to be created thanks to the light variation and color changes. The rhythm, animations, and emphasis of the space is dependent on which specific lighting system is installed above the Barrisol® translucent membrane.

Barrisol Lumière Color® ermöglicht eine Vielzahl an Stimmungen, dank der Licht- und Farbvariation. Spezifische Beleuchtungssysteme werden oberhalb der transluziden Folien Barrisol® installiert. So wird das Licht von extremer Intensität bis hin zu sehr gedämpft angepasst.



Arch. : Edo Kadribegovi





Arch. : Wacław Matlok & Magdalena Dendewicz-Matlok



Arch. : Hiikka Maija Antila, Markus Jakas and Bassel Dallou pour Architect bureau Nurminen Antila & Co



Arch. : Tanner Kibble Denton & GHD (Tanner GHD)





Barrisol® Caisson lumineux et système EasyAccess® - Barrisol® illuminated light box and EasyAccess® system - Barrisol®-Lichtkästen und EasyAccess®-System

# Barrisol® Caissons lumineux

## Illuminated light boxes ■ Lichtkästen



Federation Square



Euro Airport



Rosengaarden shopping



Volvo Baku



Lok fu shopping

Les caissons lumineux Barrisol® sont des cadres ouvrants qui facilitent l'accès aux éléments techniques placés à l'intérieur. Grâce à la technologie EasyAccess®, les caissons lumineux s'ouvrent automatiquement avec une télécommande. Toute maintenance pour des changements de LEDs ou de fluos est simplifiée. Les caissons lumineux Barrisol® peuvent être acoustiques et imprimés.

The Barrisol® illuminated light boxes are openable frameworks which facilitate the access to technical elements placed inside. Thanks to the technology of EasyAccess®, the illuminated light boxes open automatically via a remote control. Any maintenance for changing LEDs or fluorescent tubes is simplified. In addition, the Barrisol® illuminated light boxes can be realized in acoustic and/or printed versions.

Leuchtkästen von Barrisol® bestehen aus Rahmen, die sich leicht öffnen lassen, um darin technische Elemente unterzubringen. Dank der EasyAccess®-Technologie können die Leuchtkästen ganz einfach mit einer Fernsteuerung geöffnet werden. Wartungsarbeiten für den Austausch von LEDs oder Leuchtstoffröhren gehen so schneller und leichter von der Hand. Barrisol® Leuchtkästen stehen auch in lärmämmender und bedruckter Ausführung zur Verfügung.



Arch. : Lab Architecture Studio & Bates Smart

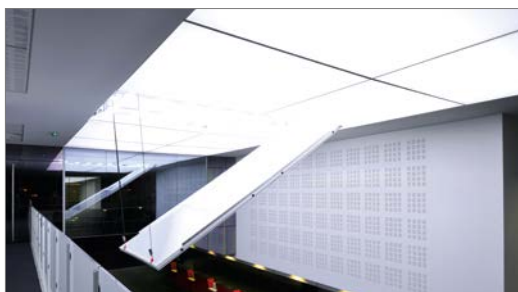

Arch. : Isabelle Mallet  
Barrisol® Lumière®, cadres ouvrants - Barrisol Light®, opening frames - Barrisol® Licht, rahmen öffnen

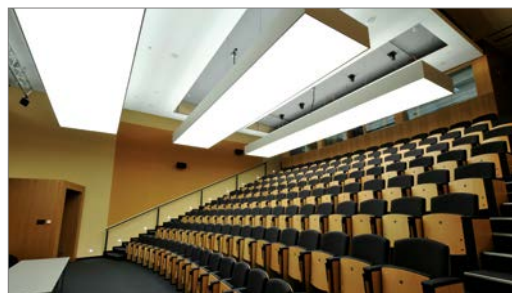
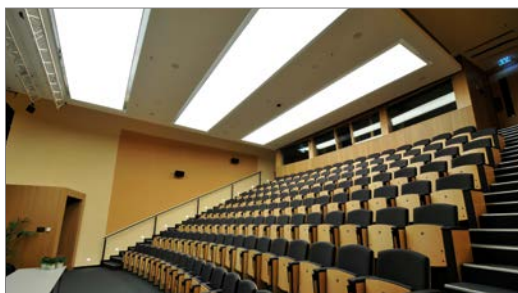

Arch. : BENG Atelier d'Architecture Esch sur Alzette



## Caissons | Boxes | Kästen



Arch. : Polyform



Design : cabinet Prache



Arch. : Dario Angeli





Design : BS GROUP Taleh Aliyev



Arch. : Ronald Lu & Partners



Arch. : Atilla Kuzu/Levent Çirpici - ZOOM TPU



Arch. : Graber Pulver Architekten AG

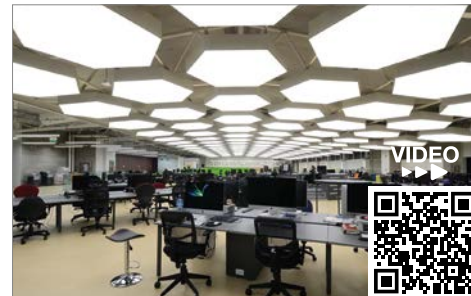

Arch. : Parq Projecto Arquitectura

# Barrisol®

## Luminaires ■ Lightings ■ Leuchtendesign



Office



Immeuble Renaissance



Arkas Logistic

Grâce à la souplesse de ses toiles et la flexibilité de ses profils en aluminium, Barrisol® réalise des luminaires, au service des architectes, designers et créateurs. Toutes les formes peuvent être conçues des plus classiques au plus originales. Animés de LEDs ou de fluos, de variations de couleurs et d'intensité, les luminaires Barrisol® laissent toute liberté de création. Les toiles peuvent être imprimées.

Thanks to the range and flexibility of its membranes and aluminum profiles, Barrisol® realizes lamps according to the architects, designers and artists imagination. All shapes can be conceived from the most classical to the most original forms. Animated with LEDs or fluorescent tubes, colors and intensity variations, Barrisol® lamps offer full freedom of creation. The membranes can be printed.

Dank unseres Fachwissens und der Qualität unserer Folien baut Barrisol® Lichtdecken, die von Architekten und Designern ausgedacht werden. Form, Farbe, Licht, alles wird möglich. Die Barrisol® Lichtdecken erlauben Phantasie und Design und bringen alle Räume zur Geltung. Die Folien können bedruckt werden.



Arch. : Saffet - Ahmet Gozlukaya



Designer : Watt Network  
Luminaire XXL - XXL lightings - XXL-Leuchtkörper



Arch. : E-KARE Architectur



Arch. : Nihal Sezgi





Arch. : Space 9  
Luminaire XXL - XXL Lightings - XXL-Leuchtkörper



Design : XY Architecture  
Luminaire XXL - XXL Lightings - XXL-Leuchtkörper



Arch. : Chapman Taylor

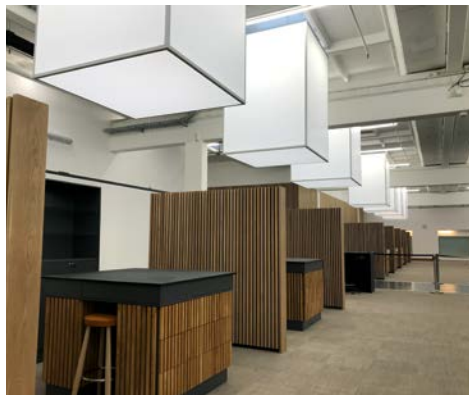

Arch. : Kullegaard



Arch. : Jochen Schröder & Tobias Link Lichtplanung



Arch. : Kreatif Architecture  
Luminaire XXL - XXL Lightings - XXL-Leuchtkörper



Arch. : Tolgo Arkan- MPU Architects  
Luminaire XXL - XXL Lightings - XXL-Leuchtkörper



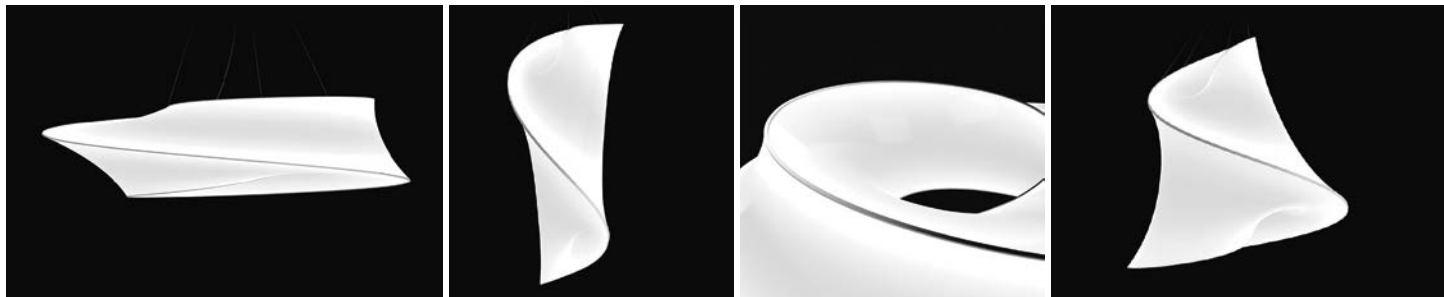

Designer : Ross Lovegrove for Barrisol®

# Barrisol® Lovegrove



reddot award 2015  
best of the best



Barrisol®  
Lovegrove

Une multitude de récompenses pour les lampes sculptées Barrisol® Lovegrove

A host of awards for Barrisol® Lovegrove sculpted lamps

Eine Vielzahl von Auszeichnungen für Barrisol® Lovegrove geformte Lampen

La collection de lampes Barrisol® by Lovegrove illustre l'équilibre parfait entre forme organique et haute technicité. Les qualités et la souplesse des toiles et structures Barrisol®, ont permis la création de superbes objets inspirés de la nature, qui non seulement illuminent les espaces mais aussi améliorent l'environnement acoustique.

The Barrisol® by Ross Lovegrove collection illustrates the perfect balance between organic form and high technicity. Qualities and flexibility of Barrisol® sheets and structures enabled the creation of exceptional objects inspired by nature, which not only illuminate but also offer an acoustic comfort enhancement of the spaces.

Die Sammlung von Barrisol® Lampen Lovegrove zeigt die perfekte Balance zwischen organischer Form und Hochtechnologie. Die Qualität und die Flexibilität der Barrisol® Spannfolie und Strukturen, haben, inspiriert von der Natur, schöne Objekte geschaffen, die nicht nur die Räume beleuchten, sondern auch die akustische Umgebung verbessern.

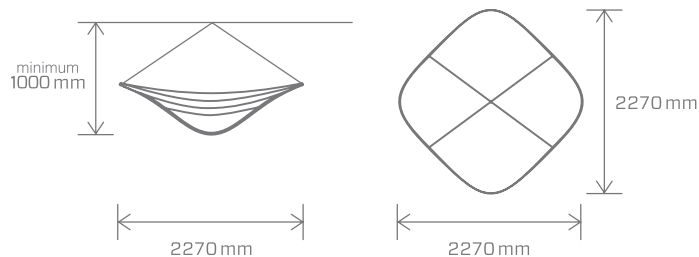





Designer : Ross Lovegrove for Barrisol®



Designer : Ross Lovegrove for Barrisol®



Designer : Ross Lovegrove for Barrisol®

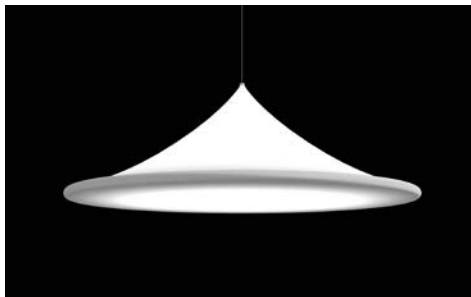

Designer : Piero Castiglioni for Barrisol®

# Barrisol® Castiglioni



Barrisol®, leader mondial du plafond tendu, offre aux architectes et designers des possibilités illimitées de création. L'expertise et l'expérience Barrisol®, au service des créateurs, donnent vie aux projets les plus originaux partout dans le monde.

Avec Piero Castiglioni, c'est une histoire de famille à laquelle nous rendons hommage en créant la lampe 1954 grâce aux propriétés uniques des produits Barrisol® et le savoir-faire exceptionnel de Barrisol®.

As the world leader of stretched ceiling, Barrisol® offers illimited possibilities of creation to architects and designers. Barrisol®'s exceptional experience and expertise make most original projects in the world possible.

With Piero Castiglioni, and the creation of the 1954 lamp we paid a tribute to a family history, thanks to the unique qualities of the Barrisol® products and exceptional Barrisol®'s know how.

Als Weltmarktführer von Spanndecken, eröffnet Barrisol® Architekten und Designern nahezu unerschöpfliche Gestaltungsmöglichkeiten. Barrisol® einzigartige Erfahrung und Kompetenz ermöglichen außergewöhnliche Projekte weltweit.

Mit Piero Castiglioni, und der Kreation der 1954 Lampe zollen wir Tribut an eine historische Familiengeschichte. Das ist das Ergebnis der spezifischen Eigenschaften der Barrisol® Produkte und des einzigartigen Know-hows von Barrisol®.

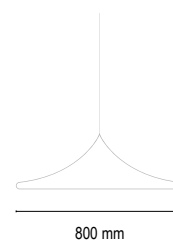
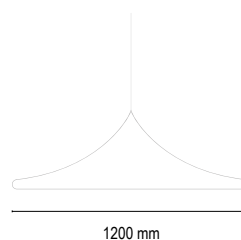
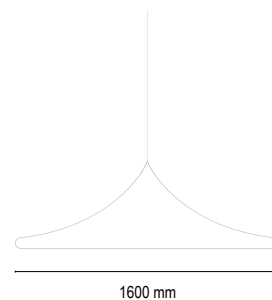
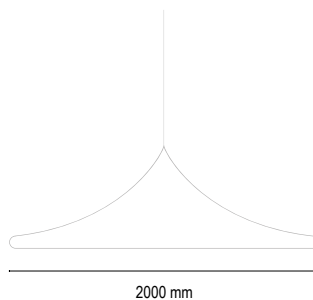



Designer : Piero Castiglioni for Barrisol®



Designer : Piero Castiglioni for Barrisol®



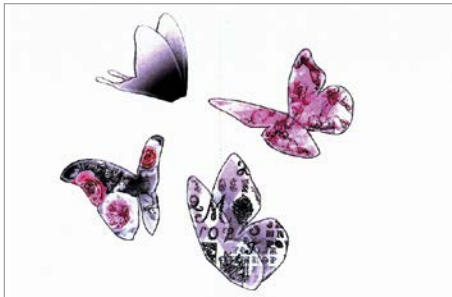

Designer : Chantal Thomass

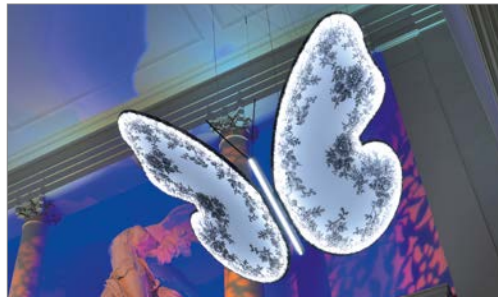
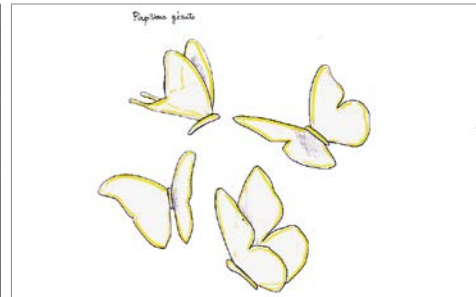
Designer : Chantal Thomass - Butterfly Lamp® by Chantal Thomass  
Taille L - Size L - Größe L

# Barrisol® Butterfly Lamp®

## By Chantal Thomass

JANUIS 2018  
DE L'INDUSTRIEMention EXCELLENCE  
Butterfly Lamp® by  
Chantal ThomassVIVA LIGHT 2018  
Butterfly Lamp® by  
Chantal ThomassChantal Thomass  
et OsramRestaurant  
Le Buerehiesel

Issu de la collection de Luminaires créée par Chantal Thomass pour Barrisol®, en partenariat avec Osram, ce papillon diffuse un éclairage doux pour une ambiance féérique.

Dimmable, il peut aussi être très lumineux pour des intérieurs qui le nécessitent. Sculpture géante, cette suspension magistrale illumine les intérieurs avec poésie.

From the collection of light fixtures created by Chantal Thomass for Barrisol® in partnership with Osram, this butterfly diffuses soft lighting for a magical atmosphere. It can be dimmed or become very bright in spaces that need more light. This great sculptural suspension poetically lights up interiors.

Aus der Sammlung der von Chantal Thomass für Barrisol® und Partner Osram kreierten Beleuchtungskörper entnommen, verbreitet der Schmetterling ein sanftes Licht und zauberhafte Stimmung.

Mit Dimmer versehen, kann er ebenso gut sehr hell beleuchten, sollte das Interieur dies erfordern. Gleich einer riesenhaften Skulptur beleuchtet dieses meisterliche Hängeobjekt die Innenräume voller Poesie.

Dimension grand papillon - Big butterfly size - Große Schmetterlingsgröße : 2358 mm x 1974 mm  
Dimension petit papillon - Small butterfly size - Kleine Schmetterlinggröße : 1435 mm x 1910 mm



VIDEO



Butterfly Lamp® by Chantal Thomass  
Taille M - Size M - Größe M



Design : Alix Videlier by Arcanes Minotaure

# Barrisol® Luminaire PLUS®

## By Alix Videlier



Luminaire Plus



Exposition Astana



2011  
MENTION SPÉCIAL  
TROPHÉE DU DESIGN AWARD  
BATIMAT

Luminaire au design minimaliste et épuré, Barrisol PLUS® est le fruit d'une réflexion créative entre Barrisol® et le designer Alix Videlier. Luminaire modulable et entièrement personnalisable, il peut être fixé au plafond et au mur. Grâce à un système spécifique d'éclairage par LEDs, il diffuse une lumière douce et colorée.

Fashion design with a refined style for this light structure, Barrisol PLUS® is the result of a creative thinking between Barrisol® and the designer Alix Videlier. Modular and fully customized light structure, it can be ceiling or wall mounted. Through a specific lighting system by LEDs, it provides a soft and coloured lighting.

Beleuchtung minimalistisch im schlanken Design. Barrisol PLUS® ist das Ergebnis des kreativen Schaffens von Barrisol® und dem Designer Alix Videlier. Daraus entstand ein veränderbarer und völlig personalisierbarer Beleuchtungskörper, dieser kann an der Decke oder an der Wand installiert werden. Dank seinem spezifischen LED - Beleuchtungssystem, verbreitet er ein weiches und farbiges Licht.



Design : Alix Videlier by Arcanes Minotaure





Réalisation : Tekno

Structure personnalisable et modulable  
Customizable and modular structure  
Personalisierbare und anpassbare Aufbau

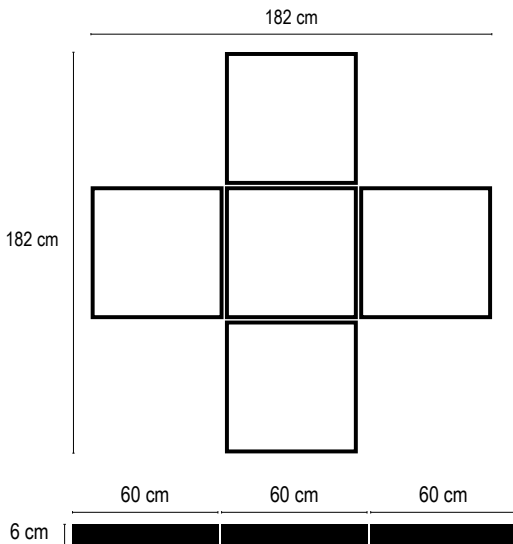

Dimensions Size Abmessungen	- Ouvert 182 cm x 182 cm - Épaisseur 6 cm	- opened : 182cm x 182cm - thickness 6 cm	- geöffnet 182cm x 182cm - Dicke 6 cm
Structure Structure Struktur	- Aluminium Barrisol® - Personnalisable - Inclinaison modulable des 4 faces	- aluminium Barrisol - customisable - adjustable angle of the 4 faces	- Barrisol Aluminium - individuell zu gestalten - Anpassbare Steigung der 4 Seiten
Habillage Finish Verkleidung	- Toile Barrisol® Translucides - 13 finitions disponibles - Imprimable	- Barrisol translucent sheet - 13 translucent Barrisol finishes - printable	- Barrisol transluzente Folien - 13 Ausführungen verfügbar - bedruckbar
Type d'éclairage Lighting system Beleuchtungssystem	- Système spécifique LEDs	- LED	- LEDs
Sécurité Safety Sicherheit	- Classement au feu BS2-d0 - Certifié CE (toile et structure)	- fire rated BS2-d0 - CE certified (sheet and structure)	- Brandverhalten BS2-d0 - EG zertifiziert (Folie und Struktur)



Lampe King® S - 150 cm



2011  
MENTION SPÉCIAL  
TROPHÉE  
DU DESIGN AWARD  
BATIMAT

Lampe King® L - 190 cm



Lampe King® XL - 250 cm

Barrisol® & Pilot Design

# Barrisol® Lampe King® By Pilot Design

Découvrez la gamme de mobilier design créée par Barrisol®. Habillés de toiles Barrisol®, les meubles et luminaires Barrisol® peuvent être totalement personnalisés pour un aménagement unique des espaces.

Discover the new furniture range created by Barrisol®. Dressed with Barrisol® membrane, printed or back lit, Barrisol® furniture and lights can be totally customized to create a unique interior space.

Entdecken Sie die Design Möbel Barrisol® Palette. Diese werden mit Barrisol® Folien verkleidet: entweder bedruckt oder beleuchtet, werden die Barrisol® Möbel laut Ihrer Phantasie ausgeführt, um einen individuell gestalteten Innenraum zu haben.



Lampe King® - Design : Barrisol® & Pilot Design



Gamme B-Skin® - Réalisation : MISE  
Design : Jean-Charles de Castelbajac



Gamme B-Skin® - Design : Barrisol® & Pilot Design

# Barrisol®

## Objets & Design By Pilot Design

Barrisol® investit le secteur du mobilier et innove en créant une gamme de meubles design. Habillés de toiles Barrisol®, imprimés et/ou lumineux, les meubles B-Skin® peuvent être totalement personnalisés pour un aménagement unique des espaces.

Barrisol® innovates in the furniture market, by creating a range of design furniture. Dressed with Barrisol® membranes, printed and/or back lit, B-Skin® furniture can be totally personalized to achieve a unique decoration of interior spaces.

Barrisol® tritt im Bereich der Einrichtung mit den Design Möbel B-Skin® auf. Diese werden mit Barrisol® Folien verkleidet: bedruckt oder beleuchtet die Möbel B-Skin® werden laut Ihrer Phantasie ausgeführt, um einen individuell gestalteten Innenraum zu haben.



Gamme B-Skin® - Wallpaper® - Design : Barrisol® & Pilot Design





2011  
TROPHÉE  
DU DESIGN AWARD  
BATIMAT



Fauteuil by Vallon®. Designer : Joël Vallon

# Barrisol® Le Fauteuil

## The armchair

## Der Lehnssessel

by VALLON

Barrisol® & le designer Joël Vallon ont créé le fauteuil totalement personnalisable. Choisir les couleurs, les images et la finition classique ou lumineuse, pour un mobilier à l'image du client.

Grâce à un système d'éclairage spécifique, le fauteuil sera mis en lumière.

Barrisol® & the designer Joël Vallon have created the armchair entirely user-adjustable. Choose the colours, the images and the standard or luminous finish and create a furniture reflecting the customer.

Thanks to a specific lighting system, the armchair will come to light.

Barrisol® und der Designer Joël Vallon haben den völlig individualisierbaren Lehnssessel geschaffen. Wählen Sie die Farbe, das Motiv und das leuchtende Finish, und schaffen Sie ein Möbelstück, das die Einzigartigkeit Ihres Kunden widerspiegelt.

Das spezifischen Beleuchtungssystem rückt den Lehnssessel ins rechte Licht.

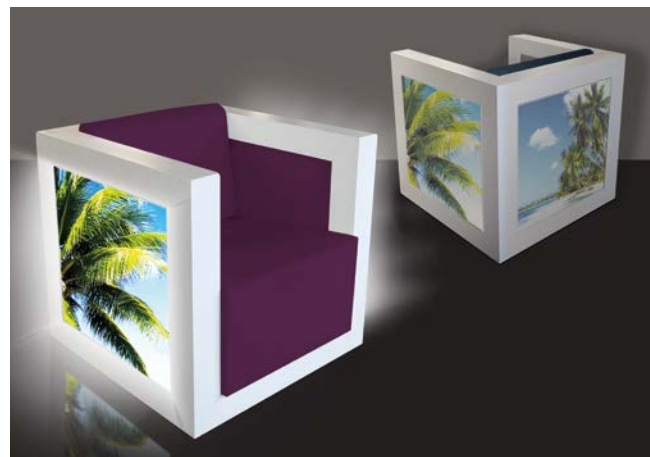

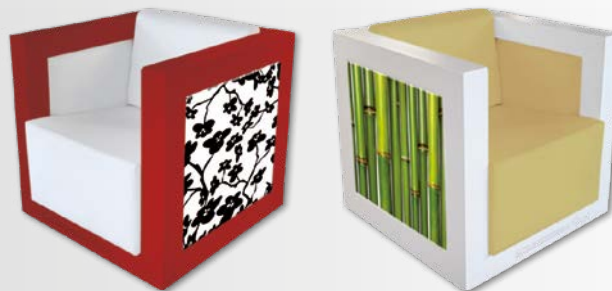

Créez votre fauteuil

Choisir les couleurs :

- Pour la structure
- Pour l'assise en finition tissu ou cuir

Choisir les images :

- Pour les 3 cadres imprimable à personnaliser. Photographies, motifs... à vous de décider.

Osez la Lumière :

- Jouez avec la lumière grâce à un système d'éclairage spécifique.

Create your personalised chair

Choose your colours:

- Of the frame
- Of the seat (leather or fabric)

Choose your images:

- For the 3 printable frames. Photos, patterns... it's your choice.

Lighting:

- It is available with a fixed White or Colour changing illumination thanks to a specific LEDs lighting system.

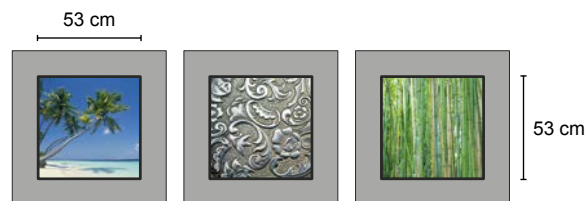
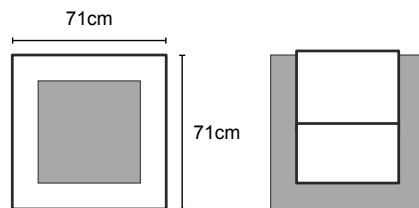

Schaffen Sie Ihren persönlichen Lehnssessel

Wählen Sie die Farben:

- der Struktur
- des Sitzes, Ausführung Stoff oder Leder

Wählen Sie die Bilder:

- der 3 personalisierbaren Rahmen
- Fotos, Motive, usw

Beleuchtung

- Spielen Sie mit Licht dank eines speziellen Beleuchtungssystems



Arch. : Jan Störmer, Störmer Murhy and Partners - Photo by Klausfrahm Fotograf®

# Barrisol® ELT3D®

Les effets lumières 3D ▪ 3D light effects ▪ 3D Lichteffekte



Présentation  
ELT3D®



Brussels Airport

Notre nouvelle gamme Barrisol ELT3D® offre un effet lumineux 3D exceptionnel grâce aux rayons lumineux produits par des LEDs sur une toile tissée. Le rendu optique désiré sera défini en fonction du positionnement et de la distance des LED RGB modulables selon les envies (en diagonale, en carré, etc.).

Ce produit peut être proposé en version acoustique avec un absorbant adapté (lumière acoustique).

Our new range Barrisol® ELT3D® provides an exceptional 3D light effect thanks to the light beams produced by LEDs on a woven fabric. The desired optical result will be defined depending on the position and distance of modular LED RGB according to the wishes (in diagonal, square, etc.).

This product can be proposed in acoustics with a suitable sound absorbent (acoustic light).

Unsere neue Produktlinie Barrisol® ELT3D® bietet außergewöhnliche 3D-Licht -Effekte. Diese Effekte werden durch die spezielle Gewebestruktur in Interaktion mit LED's erreicht. Das gewünschte optische Ergebnis wird in Abhängigkeiten der Entfernung und Anordnung der modularen RGB-LEDs (in der Diagonale, quadratisch, etc.) erreicht und kann individuell definiert werden.

Barrisol® ELT3D® kann mit einem geeigneten schallabsorbierenden Material kombiniert werden um die Raumakustik signifikant zu verbessern (akustische Licht).



Réalisation : Barrisol®  
Effet ondulation - Ripple Effect - Wellenförmiger Tiefeneffekt



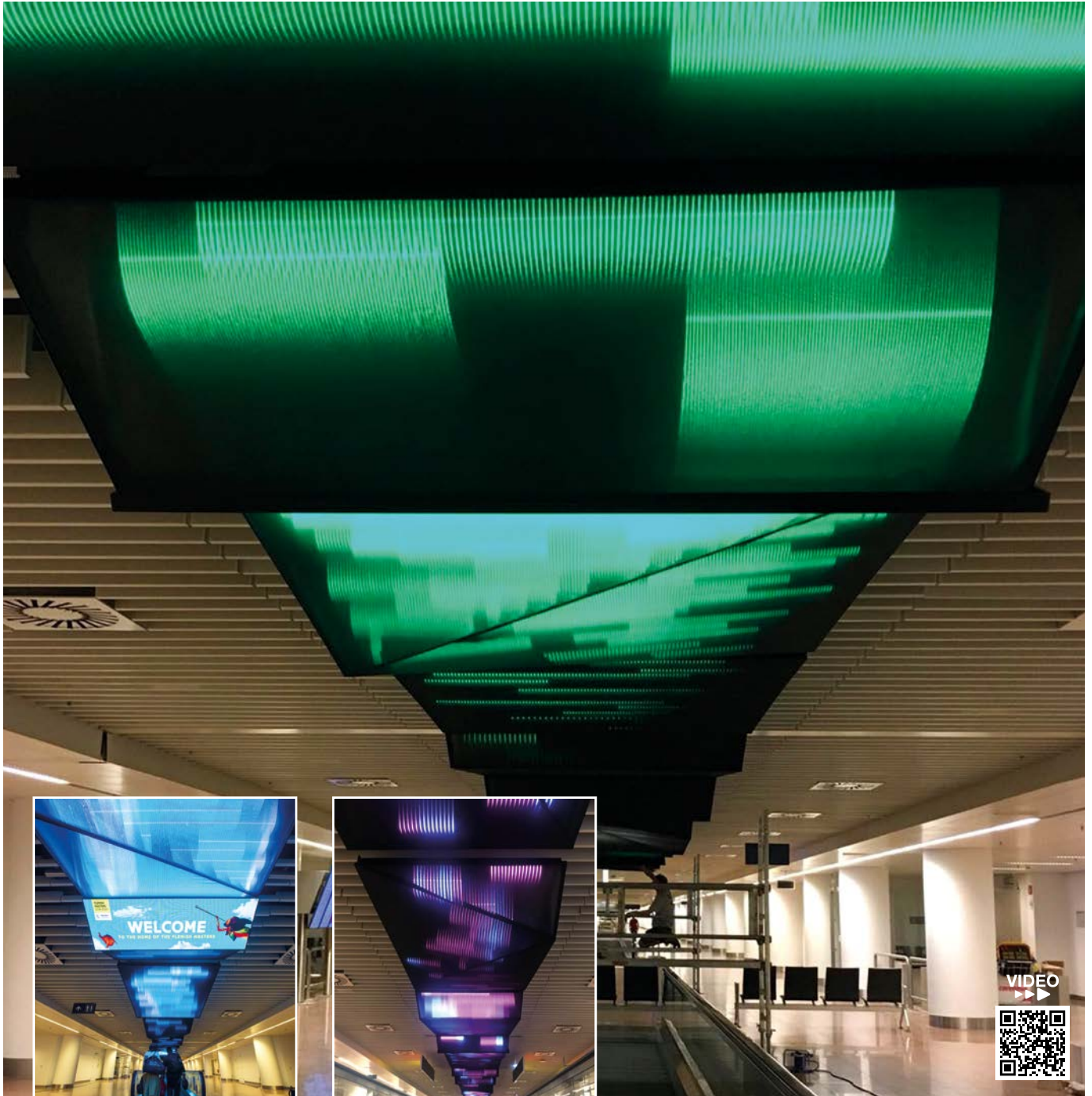

Design : ACTLD.com  
Effet Vague - Wave Effect - Welle Effekt



Intérieurontwerp Gerd Couchhuyt



Réalisation : Juan Muro



Réalisation : Martín Azúa

# Barrisol®

## Mural ■ Mural ■ Wand



Private House



Optus

Les systèmes de fixation Barrisol Star® en aluminium permettent aussi la réalisation de cloisons et de murs en 3D, concaves, convexes ou encore lumineux.

En imprimé, Barrisol® mural offre une multitude de possibilités d'aménagement, pour personnaliser un espace ou créer une signalétique.

The Barrisol Star® allows the realization of 3D, concave and convex wall shapes that can be made luminescent via back lighting. Furthermore by printing the Barrisol® membrane a multitude of solutions can be created to personify a space or create a designer's signature.

Die Barrisol Star® Befestigungssysteme aus Aluminium ermöglichen auch die Ausführung von Zwischenwänden und 3D-, konkaven oder konvexen, ja sogar Leucht-Wänden.

Als Druckversion bietet Barrisol® mural eine Vielzahl von Ausstattungsmöglichkeiten, mit denen Räume individuell gestaltet werden können oder die Handschrift des Designers hervorgehoben wird.

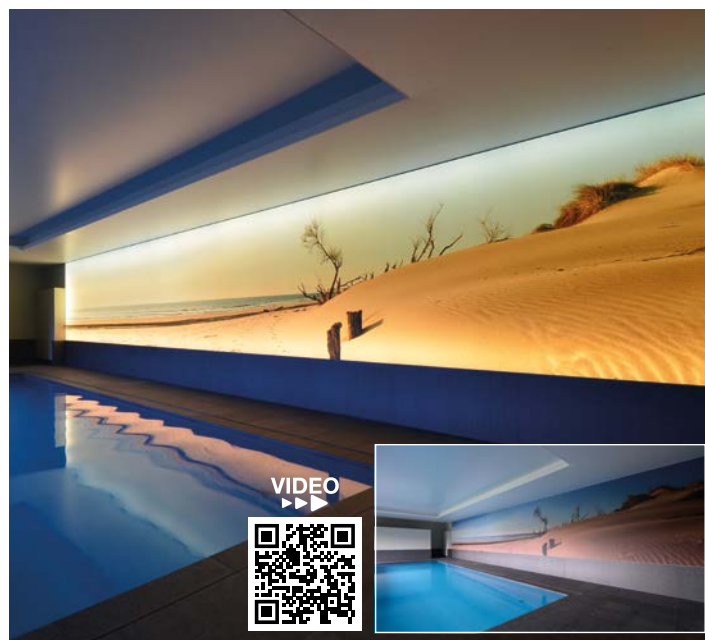

VIDEO



Architecte d'intérieur : Kurt Demeulemesster



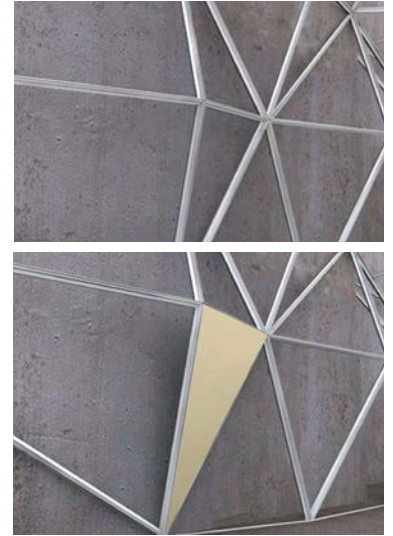

Barrisol® mural forme 3D et Lumière Color® - arch. : Ciro Maricini & Attilio Terragni



Barrisol® mural imprimé - architecte : Hilmi Şenalp



Arch. : Yves Lussier



Ing. : Giorgio Massa



Barrisol® Lumière Color® - arch. : Cabinet d'architectes Arte Charpentier



Arch. : Hassell Studio Architects



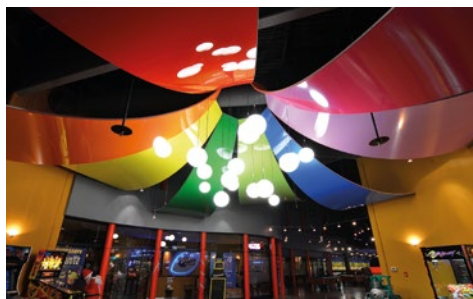

Design : Sanny Chan Design Group Ltd

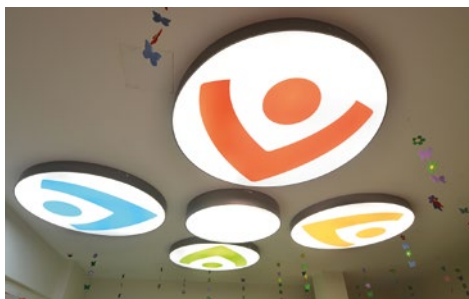

Design : Zambak Mimarlik



Design : Plural Design, M. Samjad Kandilat

# Barrisol®

## Modulaire ■ Modular ■ Modular



Next Level Mall



SonTermens

Barrisol® Modulaire offre la possibilité de créer des cadres suspendus auto-portants habillés de toile Barrisol®. Ils sont très légers, 100% recyclables et permettent la création de tous les types de formes. Pour un résultat toujours plus personnalisé, Barrisol® propose plus de 230 coloris et 15 finitions pour alterner les couleurs, les aspects (laqué, satiné, daims, imprimé, etc.) et les fonctionnalités (acoustiques, lumineux, etc.).

Barrisol® Modular consists of a suspended, self supporting frame works onto which the Barrisol® membranes are mounted. Barrisol® Modular is lightweight, 100% recyclable and available in various designs and forms. For your personal signature Barrisol® provides in excess of 230 colours and 15 finishes (lacquer, satin, suede, printed etc.). Furthermore Barrisol® Modular is available in various versions: acoustic, lighting, etc.

Barrisol® in Modulform besteht aus aufgehängten, selbsttragenden Rahmen, in die Barrisol® Folie eingefasst wird. Die Barrisol® Leicht, 100% recycelbar, es sind verschiedenen Formen möglich: Quadrate, Kreise, Ovale und gewellte Oberflächen in allen Größen. Barrisol® Modular bietet eine breite Palette an Farben (mehr als 230 Farbtöne), Fertigungen (lackiert, satiniert, beflockt, bedruckt, usw.) und Funktionen (Akustisch, beleuchtet).



Arch. : Brigitte Weber

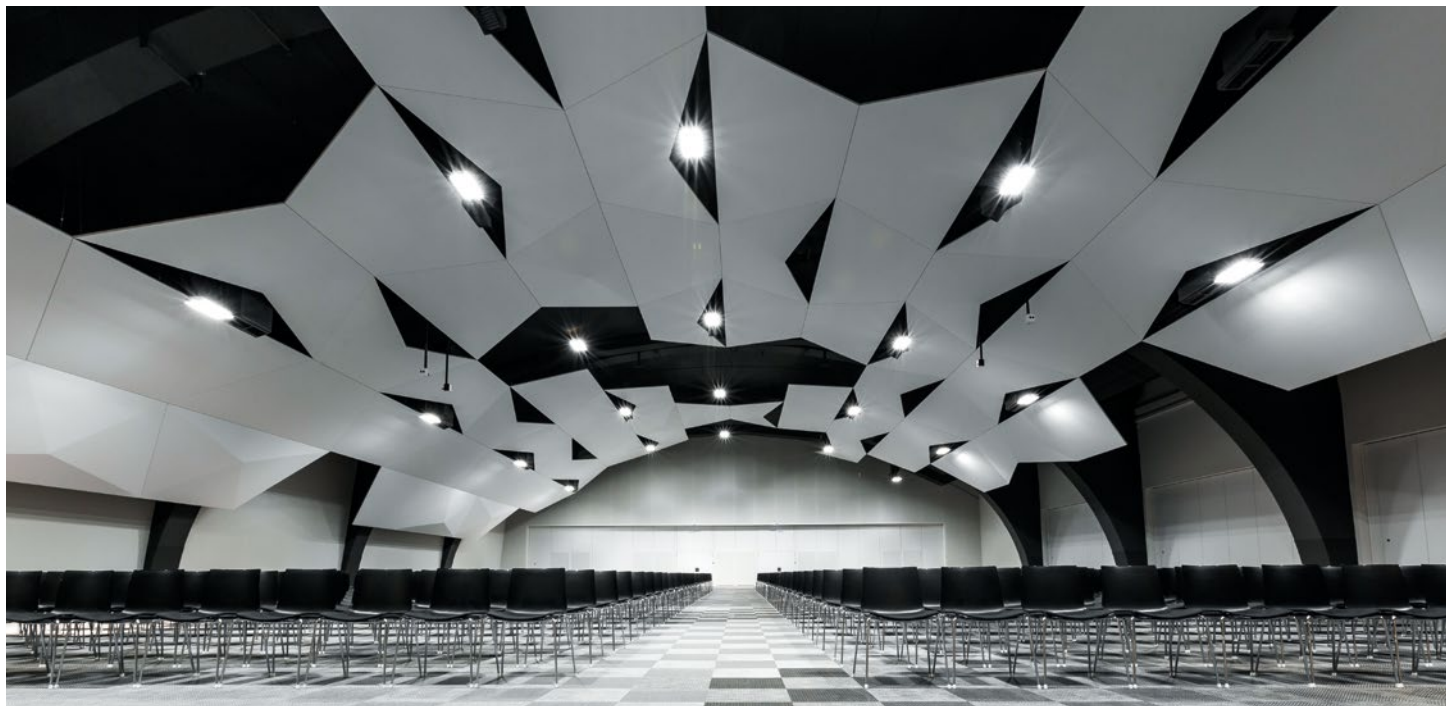

Arch. : Auntie Lucy

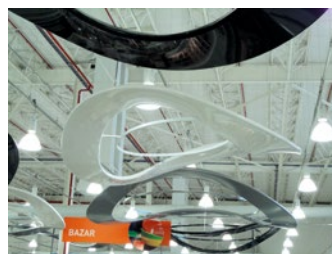

Arch. : Coto C.I.C.S.A



Arch. : Mehpare Evrenol

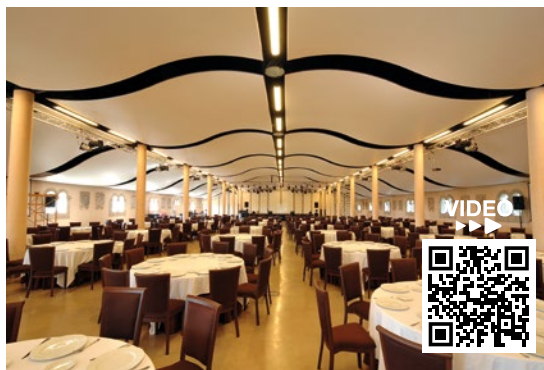

Arch. : Dolores Melgar Noguera & Pedro Alcover Montaner





Arch. : Lichttraume

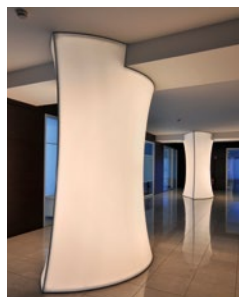

Réalisation : ATIR SRL



Arch. : Mirco

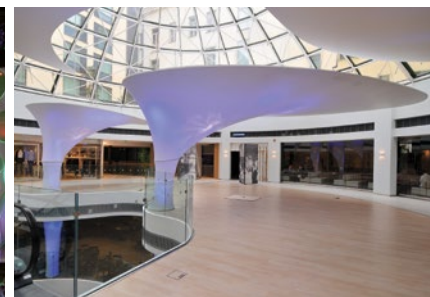

Arch. : Heidi Puttonen, Helium Design & Sami Horto, Inter Arc Oy

**Barrisol®**

# Colonne 3D ■ Column 3D ■ Säule 3D



Hotel Melia Benidorm



V City

Fort de son savoir-faire en cintrage tridimensionnel de ses profils en aluminium et riche de sa large gamme de toiles, Barrisol® permet la conception de volumes et de formes architecturales inédites en 3 dimensions.

Lumineuses, acoustiques ou imprimées et à choisir parmi notre gamme de plus de 230 coloris et 15 finitions (laquée, satinée, mate, daim, translucide, perforée), les solutions Barrisol® permettent la création de volumes aussi légers que fluides donnant à votre espace une dimension spectaculaire.

Building on its established know-how in 3D bending of its aluminum profiles, and with a large line of sheets, Barrisol® makes it possible to design original three-dimensional volumes and architectural forms.

Barrisol® solutions, be they luminous, acoustic or printed, to choose from our line of more than 230 colours and 15 finishes (lacquered, satin, mate, suede, translucent, perforated), give you the opportunity to create light and smooth volumes giving your space a spectacular dimension.

Kraft seines umfangreichen Knowhow in der dreidimensionalen Biegetechnik der Alu-Profile und dem reichhaltigen Programm an Spanndecken ist Barrisol® in der Lage, Volumenkörper und unvergleichliche architektonische 3D-Formen zu fertigen.

Mit leuchtenden, lärm-dämmenden oder bedruckten Varianten unseres Lieferprogramms aus mehr als 230 Farbtönen und Texturen (lackiert, satiniert, matt, Wildleder, durchscheinend, perforiert) können dank Barrisol® sowohl leichte, als auch fließende Volumenkörper erzeugt werden, die Ihrem Raum einen spektakulären Charakter geben.



VIDEO



Arch. : Curvics Arquitectura + Suitel Design





Arch. : Atilla KUZU/Levent ÇIRPICI - ZOOM TPU



Arch. : Lüttgenau Architekten



Réalisation : WAGG S.A.



Design : Plexgroup



Designer : Benyo



Arch. : Marek Deyl & Jan Šesták



Designer : Anjan Chatterjee

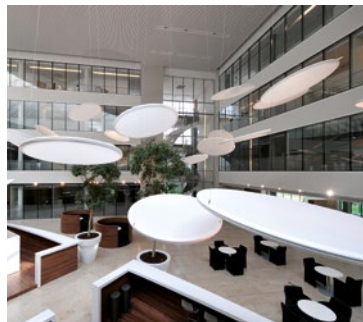

Arch. : Projectatelier



Arch. : Eco-ID Architects

## Barrisol®

# Cadres & Tubes forme 3D Frames and tubes 3D shape Rahmen & Röhren in 3D



Vodafone



Nest by Nestlé



Exposition Astana

Les Cadres et tubes forme 3D permettent de réaliser toutes les formes architecturales en reproduisant par cintrage de ses profils toutes les formes d'arcs.

Les toiles Barrisol® sont structurées et s'adaptent à toutes les architectures (anneaux, voûtes, ogives, etc...) et formes 3D (vagues, etc...).

Frames and tubes 3D shape enable the creation of any architectural shape. Because of their flexibility, they reconstruct edges and can be made in any curved shape.

The Barrisol® membranes covers the structure and adapts to the architectural shapes (rings, arches, vaulted arches, etc.) and 3D shapes.

Mit den Rahmen & Röhren in 3D ist es möglich, alle denkbaren architektonischen Formen zu schaffen, indem sich die Profile durch Verformung in alle Bogenformen fügen.

Die Barrisol® Decken sind strukturiert und passen sich allen gewünschten Architekturelementen (Ringe, Gewölbe, Kreuzgewölbe usw.) und 3D-Formen (Wellen, usw.) an.



VIDEO



Arch. : Luka Krížek, IO STUDIO





Arch. : Pulse group of London UK



Réalisation : Tekno



Arch. : Concept Consult Architects Switzerland - Scenography by Tinker





Arch. : Samad Gashov - Designer : Ruslan Habibov



Arch. : ETHOSpace PTE LTD



Arch. : Concept Consult Architects Switzerland

VIDEO



## Barrisol®

# Formes 3D ■ 3D shapes ■ 3D-Formen



2013  
MÉDAILLE D'OR  
TROPHÉE DE  
L'INNOVATION  
BATIMAT



Nest by Nestlé



Radisson hotel



ASSAS bibliothèque



Cineland Ostia

Grâce à leurs caractéristiques uniques, les profils développés par Barrisol® et sa grande variété de toiles permettent la conception de volumes et de formes en 3 dimensions. Avec cette solution, toutes les formes architecturales sont réalisables.

Thanks to the unique characteristics of the profiles developed by Barrisol® and the various Barrisol® membranes, conception and realization of various geometries and 3 dimensional shapes are possible. With Barrisol® solutions any architectural form can be achieved.

Durch die einzigartigen Eigenschaften der von Barrisol® entwickelten Profile und die große Vielfalt der Barrisol® Spanndecken ist es möglich, Volumenkörper und dreidimensionale Formen zu gestalten. Mit dieser Lösung ist jede architektonischen Form ausführbar.



VIDEO



Arch. : Christian Laquerriere



Arch. : ARINA Consultants



Design : Hakan Kùlahçi/Art Mim



Arch. : Maria Guarrera



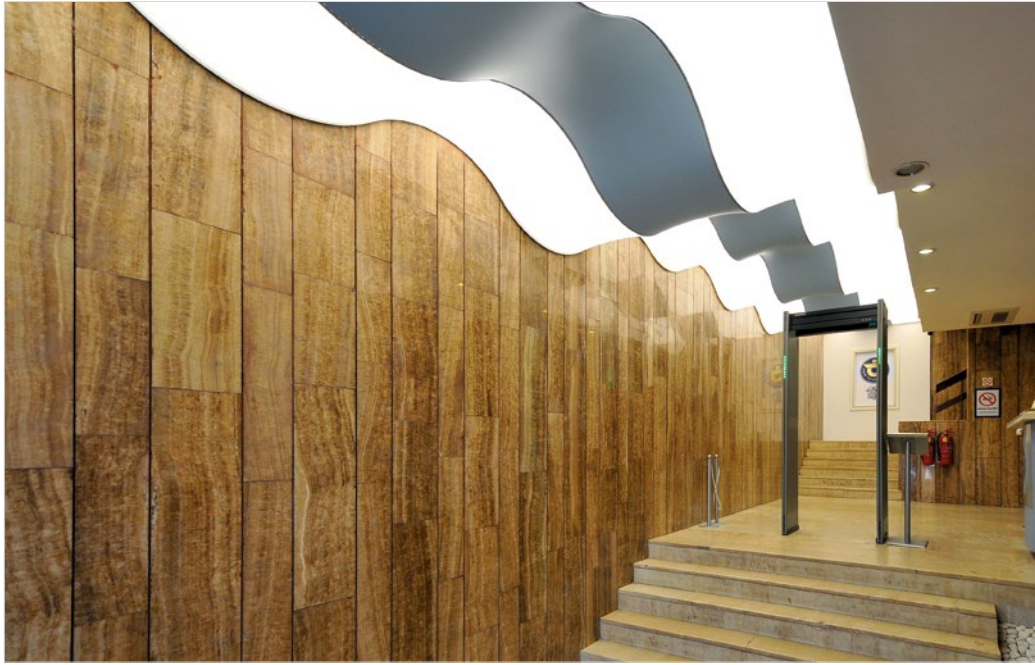

Arch. : İker Kodaman



Arch. : Carpus + Partner AG



Exemple d'une réalisation Barrisol® 3D : ellipse lumineuse - Example of a Barrisol® 3D application: illuminated ellipse  
 Beispiel einer Ausführung mit Barrisol® 3D: beleuchtete Ellipse



Exemple d'une réalisation Barrisol® 3D : tunnel - Example of a Barrisol® 3D application: tunnel  
 Beispiel einer Ausführung mit Barrisol® 3D: Tunnel

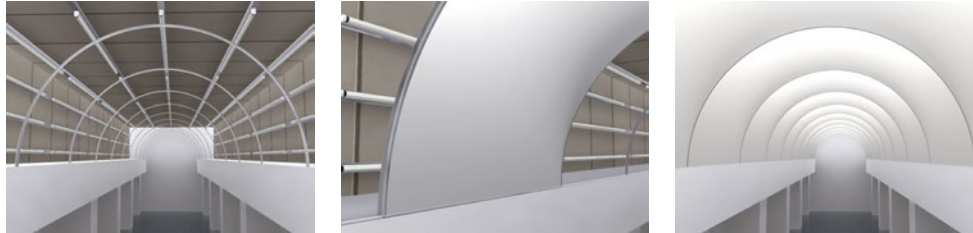

Arch. : Addon



Arch. : Marek Deyl



Arch. : Mustafa Toner



Arch. : PFZ Arquitectos



Arch. : Marc Mimram



Arch. : City Scape Architectural Studio



Arch. : İlhan Karaderi



Arch. : N Nussaume

# Barrisol®

## Print your Mind®



Casino Louis XIII



Louis Vuitton MBS



Lohr Center



Banque populaire  
de Metz



Jugo Fresh



Restaurant Le Pecarnier

Barrisol Print your Mind® permet de reproduire sur la toile Barrisol® tous types de motifs, images ou logos. Chaque projet peut ainsi être personnalisé. Avec Barrisol Print your Mind®, les possibilités de décoration sont infinies, la seule limite est celle de votre imagination.

Barrisol Print your Mind® allows the reproduction on Barrisol® membranes of any type of patterns, images or logos. Every project can be personalized. With Barrisol Print your Mind®, the possibilities of decoration become infinite, the only limit is your imagination.

Barrisol Print your Mind® gestattet die Reproduktion aller gewünschten Motive, Bilder und Logos auf den Barrisol® Decken. So kann jedes Projekt die Handschrift seines Schöpfers tragen. Mit Barrisol Print your Mind®, sind die Möglichkeiten der Dekoration unendlich und reichen so weit, wie Ihre Vorstellungskraft.

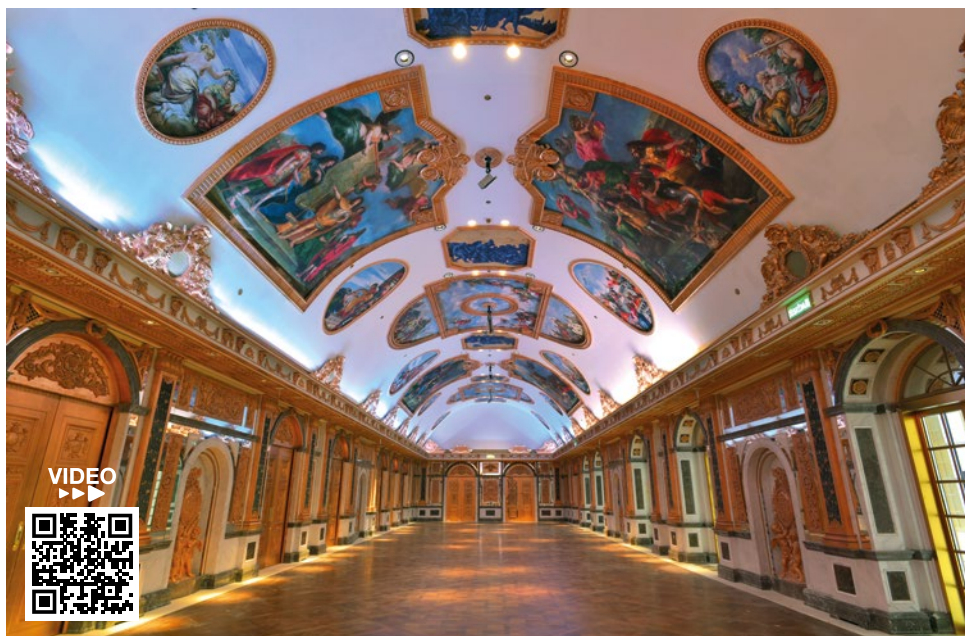

VIDEO



Arch. : Peter Silling & Associates





Design : Simon Norris



Barrisol® mural Lumière® Print your Mind® -  
Arch. : Peter Marino - illustration : R. Toledo



Arch. : Wren Architecture & Design



Arch. : Jochen Schröder & Tobias Link Lichtplanung





Arch. : Parallel Architecture



Designers : Atila Kuzu-Levent Çirpici / Zoom Mimarlık





Arch. : Alvaro Planchuelo



Arch. : Schulmann & Associates



Arch. : Jean-Michel Wilmotte



Arch. : Asiye Cengiz



Arch. : Duffy Singapore



Designer : Vallila Interiors Oy



Designer : James Law

## Barrisol®

# Projection et Jeux de lumière Projection and lighting effects Projektion und Lichtspiele



Musée Enzo Ferrari



Nest by Nestlé



Blue Planet Aquarium

Tendues sur des structures permettant de concevoir tous types de formes, les toiles Barrisol® se révèlent être de formidables supports de projection. La toile Barrisol® permet de projeter images ou mapping vidéo. En projection ou en rétro-projection, l'emploi des toiles translucides est idéalement adapté pour jouer sur les transparences et créer des ambiances scénographiques uniques.

Barrisol® sheets allowing the creation of all kinds of shapes, turn out to be great projection media. Barrisol® sheets thus be used for image projections or video mappings. Translucent sheets are the perfect choice to play with transparencies and create unique atmospheres, whether with projection or back projection.

Durch das Aufspannen auf die Tragkonstruktion können die Barrisol® Spanndecken alle Formen annehmen und sind vorzüglich als Projektionsfläche geeignet. Die Barrisol® Spanndecke gestattet es, Bilder oder Videos zu projizieren. Für die Auf- oder Hintergrundprojektion ist der Einsatz von durchscheinenden Spanndecken ideal für das Spiel mit der Transparenz und die Schaffung von einzigartigen szenischen Räumen.



Musée Casa Enzo Ferrari - Modène - Italie  
Arch. : Jan Kaplicky (Future Systems)  
et Andrea Morgante (Shiro Studio)





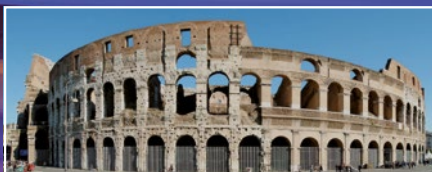
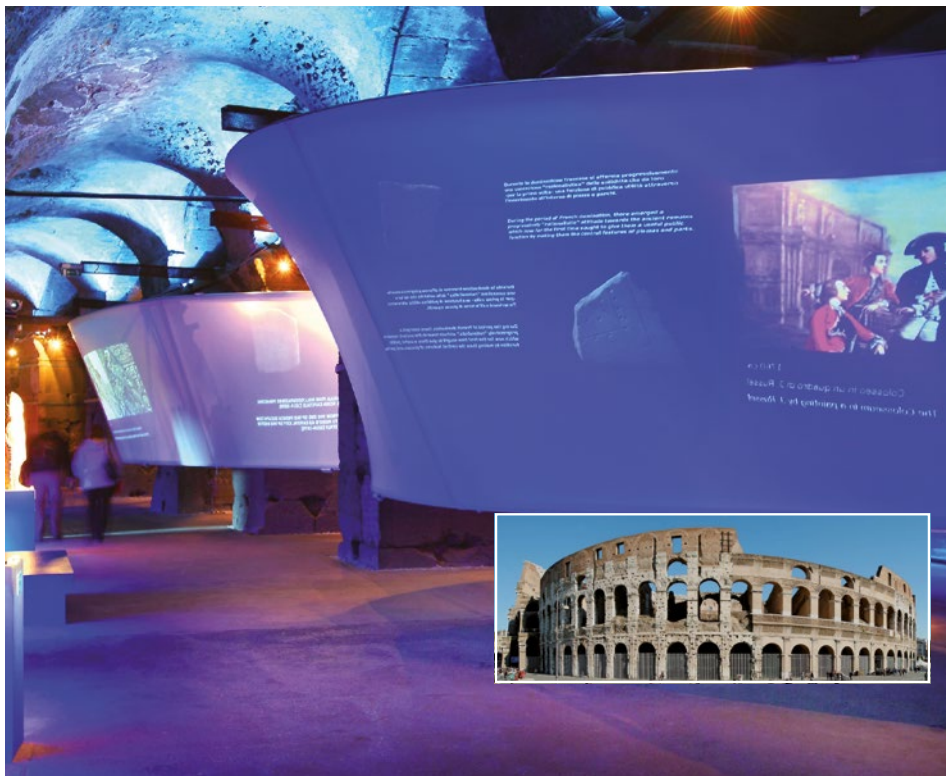

Colisée de Rome - Italie - arch. : Doriana et Massimiliano Fuksas



Le Casino de Charlevoix - Multimédia et projection : Moment Factory  
Arch. : John Archibald



Arch. : Concept Consult Architects Switzerland - Scenography by Tinker



Arch. : 3XN

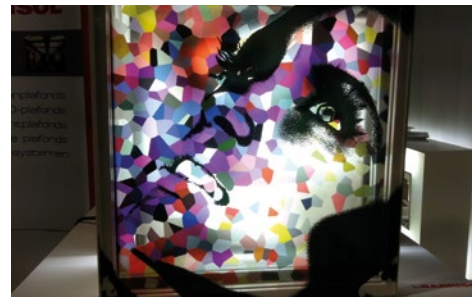
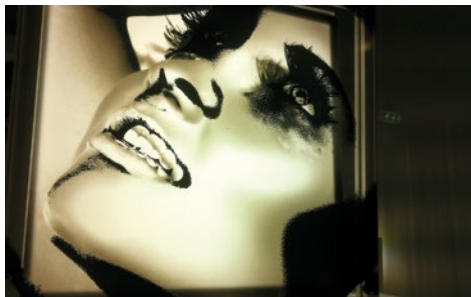
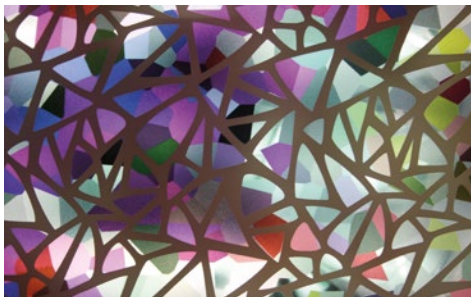

# Barrisol® Layers Concept®



Il Castello Moncalieri



Jaga Saga



MISE

Barrisol Layers Concept® est une nouvelle application originale des toiles et systèmes Barrisol® qui permet de donner une nouvelle dimension aux surfaces imprimées et de créer un effet visuel de profondeur et de mouvement, à vos plafonds ou vos murs. Barrisol Layers Concept® est la superposition de plusieurs toiles PVC translucides Barrisol® imprimées, associées à un système de fixation exclusif Barrisol®, conçu de manière à laisser un espace entre chaque toile. L'utilisation d'un système d'éclairage spécifique par LEDs permet de créer une nouvelle dimension visuelle dans tous les types d'espaces qu'ils soient publics ou privés.

Barrisol Layers Concept®, is a brand new way of utilising Barrisol® membranes and systems. This offers original 3D visual effects for printed ceilings or walls. By strategically placing several Barrisol® printed translucent sheets in conjunction with the exclusive Barrisol® edge retention system we can offer a new depth and perception when using printed sheet. The use of the specific LED lighting system creates a new visual effect for environment - public, commercial or residential.

Barrisol Layers Concept® ist eine neue Anwendung der ursprünglichen Spanndecken und Systeme von Barrisol®, mit der es möglich ist, bedruckten Flächen eine neue Dimension zu geben und einen visuellen Effekt der Tiefe und der Bewegung auf Ihren Decken und Wänden zu erzeugen.

Das Barrisol Layers Concept® beruht auf der Überlagerung von mehreren durchscheinenden und bedruckten Barrisol® PVC-Spanndecken, die so angeordnet werden, dass sich zwischen den einzelnen Spanndecken ein Zwischenraum befindet. Durch die Verwendung eines speziellen Beleuchtungssystems mit LEDs ist es möglich, in allen Räumen, seien es öffentliche Einrichtungen oder private Räume, eine neue visuelle Dimension zu erzeugen.



Arch. : Beppe Merlano - Maria Carla Visconti  
We thank the Ministry of Goods and Cultural Activities and Tourism - Pole Museum of Piedmont



Arch. : Todd Architects





Design : Ross Lovegrove



Arch. : Studio Arne Quinze



Réalisation : Barrisol®



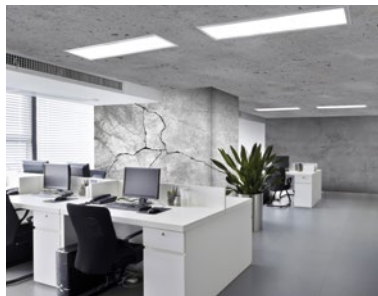

Murs - Walls - Wände : ref.: BEB04 et ref.: BEB01 -  
Plafond - Ceiling - Decke : réf.: BEB01

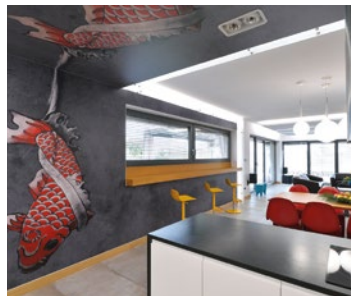

Arch. : Katarzyna Zachariasz-Rybak



Design : SZM

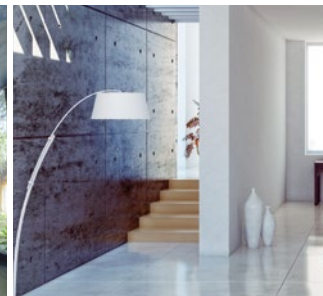

Design : Barrisol®



# Barrisol®

## Les Effets Béton®

### Concrete effect

### Beton Effekt



Grandhotel Pupp

Toujours à la pointe de l'innovation, Barrisol® invente l'effet béton. Son parfait effet trompe-l'œil, rendu possible par une impression numérique de haute définition s'associe à la technicité et aux performances des toiles et systèmes brevetés Barrisol®. Une multitude de variantes sont disponibles, des plus authentiques aux plus fines... Associé aux toiles translucides, le béton devient lumineux pour un rendu spectaculaire, sans limite de taille.

Always at the cutting edge of innovation, Barrisol® has invented the concrete effect. With a perfect trompe-l'œil effect, made possible by high definition digital printing, it has all the advanced technical features and performance of patented membranes and systems from Barrisol®. A large number of alternatives are available, from the most authentic to the finest... When used in combination with translucent membranes, concrete can become luminous and have a spectacular appearance, with no size restrictions.

Immer an der Spitze der Innovation, Barrisol® erfindet den Effekt Beton. Der spezielle Effekt „Trompe-l'œil“ ermöglicht hochauflösende digitale Drucktechnik in Kombination von technischen Hochleistungsfolien und den patentierten Barrisol® - Systemen. Eine Vielzahl von Varianten sind verfügbar, authentischer, feiner... mit transluziden Folien, wird der Beton hinterleuchtet für eine spektakuläre Inszenierung ohne Größenbegrenzung.

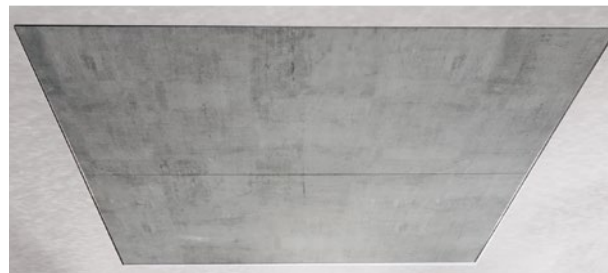

*Sans Lumière / Without light / Ohne Licht*



*Avec Lumière / With light / Mit Licht*



Mur - Wall - Wand : ref. : BEB07

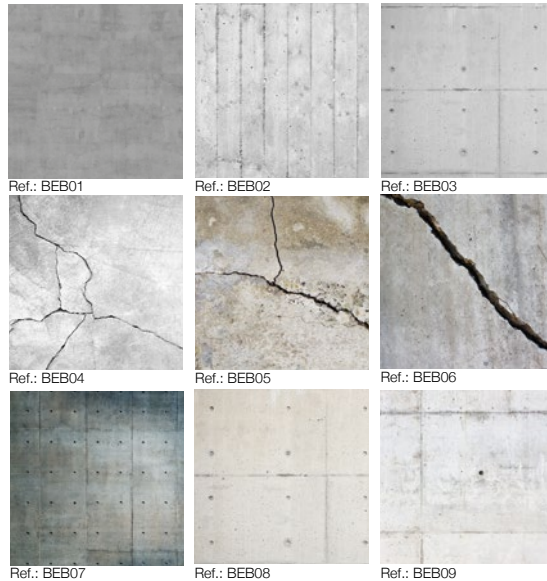

votre  
visuel

Barrisol® vous offre la possibilité d'imprimer votre propre Effet Béton !

Barrisol® offers you the possibility to print your own Concrete Effect!

Mit Barrisol® können Sie Ihren eigenen Beton-Effekt drucken!



**Béton Imprimé Artolis® optima**  
**Artolis® optima printed concrete**  
**Artolis® optima bedruckter Beton**

Mesures selon la norme internationale ISO 11654 et américaine ASTM C 423.  
Measurement according to international standard ISO 11654 and US standard ASTM C 423.  
Messungen nach der Internationalen Norm ISO 11654 und der US-Norm ASTM C 423.

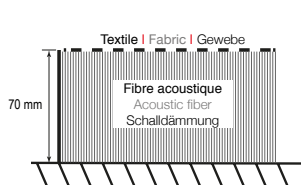

NRC = 0.95  
SAA = 0.98  
 $\alpha_w = 1.0$

classe - class - Klasse: A

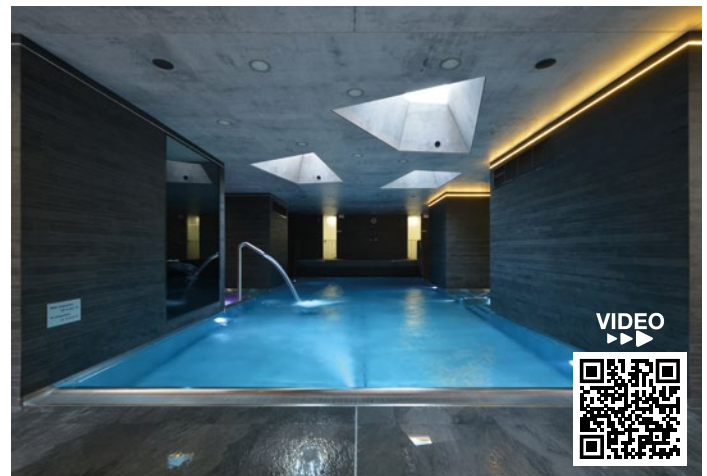
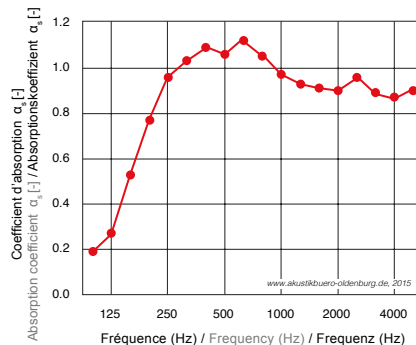

VIDEO



Arch. : Karel Mrázek



Plafond - Ceiling - Decke : ref.: BEW04  
Murs - Walls - Wände : ref.: BEW09



Réalisation : Barrisol®

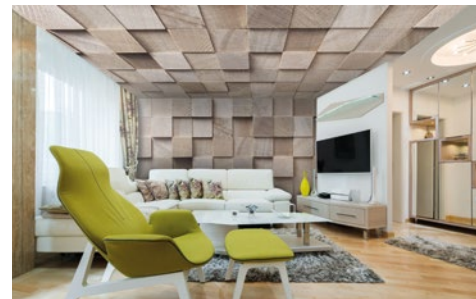

Plafond Barrisol® et mur Artolis® motif cubes de bois  
Barrisol® ceiling and Artolis® wall wood cubes motif  
Barrisol®-Decke und Artolis®-Wand mit Holzwürfel-Motif ref.: BEW01



# Barrisol®

## Les Effets Bois®

### Wood effect

### Holz Effekt



Rosengaarden  
shopping

Transformez le bois en un matériau souple et léger, acoustique, lumineux ou s'adaptant à toutes les formes... C'est ce que vous propose la toute nouvelle gamme Matières de Barrisol®.

Lorsque le bois devient lumineux, c'est toute la magie des revêtements Barrisol® qui opère. En murs ou en plafonds, faites entrer la lumière dans vos intérieurs grâce aux revêtements translucides imprimés lumineux.

En plus du rendu lumineux, profitez également du confort acoustique grâce au système de micro-perforations.

Barrisol® vous offre aussi la possibilité d'imprimer votre propre Effet Bois !

Turn wood into a flexible and lightweight material with acoustic and luminous properties, which can be adapted to all shapes... That is what the exciting new Matières range from Barrisol® promises to do.

Barrisol® finishes come into their own by making wood look resplendent. Luminous translucent print membranes bring light into your spaces when applied on walls or ceilings.

And while you add radiance, you can also improve the acoustics. Barrisol® offers you the possibility to print your own Wood Effect!

Verwandeln Sie Holz in einen flexiblen und leichten, akustischen und leuchtenden Stoff, der sich allen Formen anpassen lässt... Das bietet Ihnen das völlig neue Sortiment Matières von Barrisol®.

Wenn das Holz zu leuchten beginnt, kommt der bezaubernde Charme der Barrisol®-Bezüge gänzlich zum Tragen. Ob an der Wand oder an der Decke - dank der leuchtenden lichtdurchlässigen Druckbezüge können Sie das Licht in Ihre Innenräume holen. Damit wird der Stoff nicht nur zum Leuchten gebracht, sondern zugleich mit akustischen Eigenschaften ausgestattet.

Mit Barrisol® können Sie Ihren eigenen Holz-Effekt drucken!





Plafond imprimé motif planches de bois - Printed ceiling wood planks motif -  
Decke bedruckt mit Holzbretter-Motif - ref.: BEW06

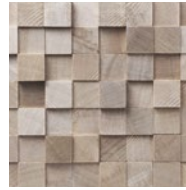

Ref.: BEW01



Ref.: BEW02

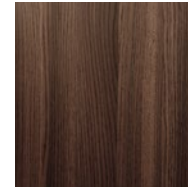

Ref.: BEW03

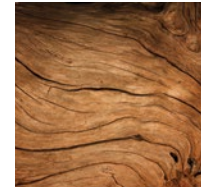

Ref.: BEW04

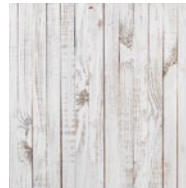

Ref.: BEW05

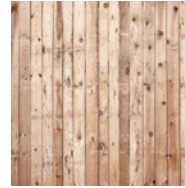

Ref.: BEW06



Ref.: BEW07



Ref.: BEW08

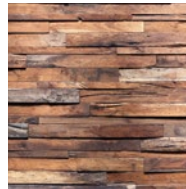

Ref.: BEW09



Ref.: BEW10

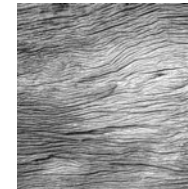

Ref.: BEW11



**Bois Imprimé Artolis® optima**  
**Artolis® optima printed wood**  
**Artolis® optima bedruckter Holz**

Mesures selon la norme internationale ISO 11654 et américaine ASTM C 423.  
Measurement according to international standard ISO 11654 and US standard ASTM C 423.  
Messungen nach der Internationalen Norm ISO 11654 und der US-Norm ASTM C 423.

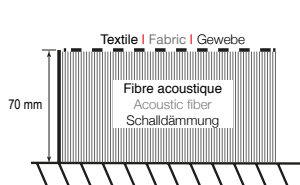

**NRC = 0.95**  
**SAA = 0.98**  
 **$\alpha_w = 1.0$**

**classe - class - Klasse: A**

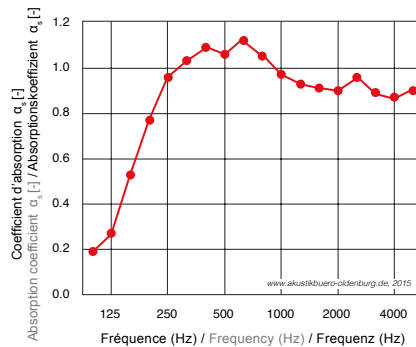

VIDEO



Arch.: Polyform

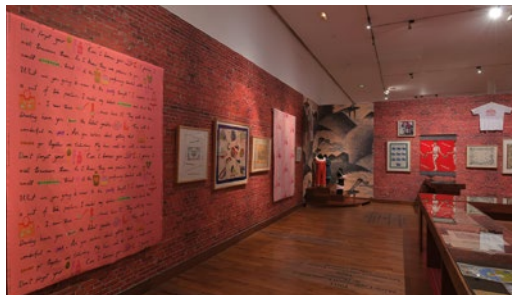

Design : MISE ref.: BEK06



Plafond - Ceiling - Decke : ref.: BEK02  
Murs - Walls - Wände : ref.: BEK05

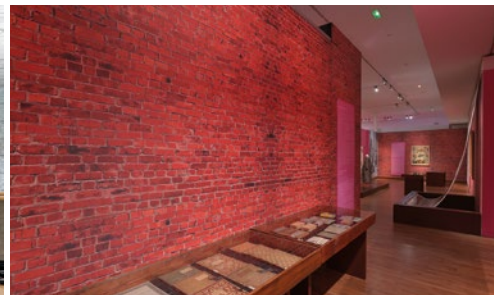

Design : MISE ref.: BEK06



# Barrisol®

## Les Effets Brique®

### Brick effect

### Backstein Effekt

Remplacez un matériau lourd comme la brique ou la pierre par un revêtement léger et innovant qui révolutionne l'architecture d'intérieur ! La légèreté des toiles Barrisol® et Artolis® permet des applications uniques avec un matériau traditionnel.

Permettre à un mur de briques d'être lumineux ne paraît pas imaginable sans la technologie Barrisol® et Artolis® translucide.

Associés à un système d'éclairage par LEDs ou par tubes fluorescents, vos murs éclairent la pièce et transmettent une ambiance chaleureuse et contemporaine.

Barrisol® vous offre aussi la possibilité d'imprimer votre propre Effet Brique !

Replace heavy materials like brick and stone with innovative lightweight materials to revolutionize interior design! Lightweight Barrisol® and Artolis® membranes allow applications out of the reach of conventional materials.

Making a brick wall luminous seems quite inconceivable without Barrisol® and Artolis® translucent technology.

When installed along with a lighting system using LEDs or fluorescent tubes, your walls will light up the room and create a warm and contemporary atmosphere.

Barrisol® offers you the possibility to print your own brick Effect!

Die Ersetzung eines schweren Baustoffs wie Tonziegel oder Stein durch einen leichten und innovativen Bezug stellt eine Revolution in der Innenarchitektur dar ! Dank der Leichtigkeit der Barrisol® und Artolis® Stoffe werden Anwendungen machbar, die mit traditionellen Materialien unvorstellbar wären.

Eine Ziegelsteinwand zum Leuchten zu bringen wäre ohne die lichtdurchlässige Barrisol® und Artolis®-Technologie kaum vorstellbar. In Verbindung mit einem LED-Beleuchtungssystem oder mit Leuchtstoffröhren erhellen Ihre Wände den Raum und strahlen eine gemütliche und moderne Atmosphäre aus.

Mit Barrisol® können Sie Ihren eigenen Backstein-Effekt drucken!





Plafond imprimé motif brique - Plafond imprimé motif brique -  
Bedruckte Decke mit Stein-Muster - Réf. BEK12

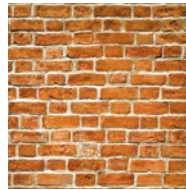

Ref.: BEK01



Ref.: BEK02

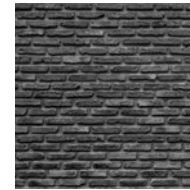

Ref.: BEK03



Ref.: BEK04



Ref.: BEK05



Ref.: BEK06



Ref.: BEK07

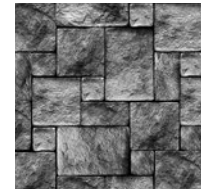

Ref.: BEK08



Ref.: BEK09



Ref.: BEK10

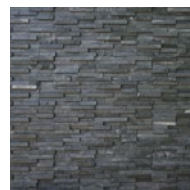

Ref.: BEK11

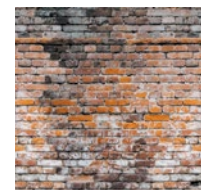

Ref.: BEK12

votre visuel



**Brique Imprimé Artolis® optima**  
**Artolis® optima printed brick**  
**Artolis® optima bedruckter Backstein**

Mesures selon la norme internationale ISO 11654 et américaine ASTM C 423.  
Measurement according to international standard ISO 11654 and US standard ASTM C 423.  
Messungen nach der Internationalen Norm ISO 11654 und der US-Norm ASTM C 423.

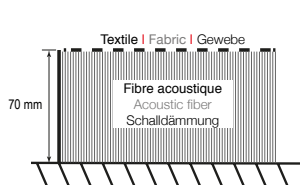

**NRC = 0.95**  
**SAA = 0.98**  
 **$\alpha_w = 1.0$**

classe - class - Klasse: **A**

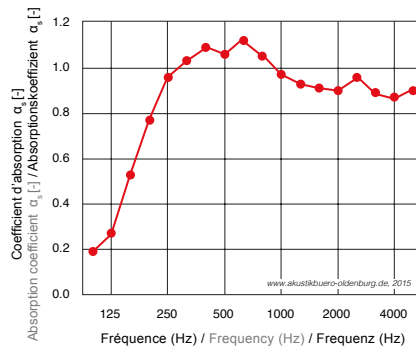

Mur Artolis® imprimé motif - Artolis® wall motif - Artolis®-Wand mit Motif - Ref.: BEK09





Murs - Walls - Wände : ref. : BER04

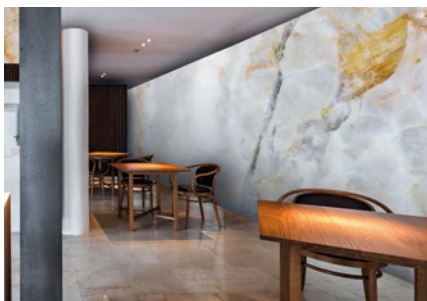

Murs - Walls - Wände : ref. : BER09



Murs - Walls - Wände : ref. : BER03



# Barrisol®

## Les Effets Marbre®

### Marble effect

### Marmor Effekt

Transformez le marbre en un matériau souple, léger, acoustique, lumineux ou s'adaptant à toutes les formes...

C'est ce que vous propose la toute nouvelle gamme Matières de Barrisol®.

Imprimés en millions de couleurs sur les revêtements Artolis® et Barrisol®, les marbres investissent les lieux pour des applications illimitées.

Turn marble into a flexible and lightweight material with acoustic and luminous properties, which can be adapted to all shapes...

That is what the exciting new Matières range from Barrisol® promises to do.

When printed in millions of colours on Artolis® and Barrisol® membranes, a wide variety of marbles can be used for unlimited applications.

Verwandeln Sie Marmor in einen flexiblen und leichten, akustischen und leuchtenden Stoff, der sich allen Formen anpassen lässt. Das bietet Ihnen das völlig neue Sortiment Matières von Barrisol®.

In Millionen Farben auf Artolis® und Barrisol®-Belägen gedruckte Marmor erobern unsere Umgebung mit unbegrenzten Anwendungsperspektiven.



Design : SZM



Plafond - Ceiling - Decke : ref.: BER02

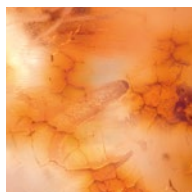

Ref.: BER01



Ref.: BER02

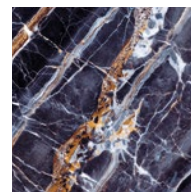

Ref.: BER03

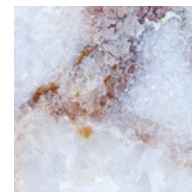

Ref.: BER04

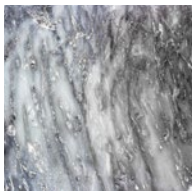

Ref.: BER05



Ref.: BER06



Ref.: BER07



Ref.: BER08



Ref.: BER09

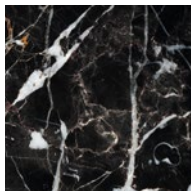

Ref.: BER10



Ref.: BER11



**Marbre Imprimé Artolis® optima**  
**Artolis® optima printed marble**  
**Artolis® optima bedruckter Marmor**

Mesures selon la norme internationale ISO 11654 et américaine ASTM C 423.  
 Measurement according to international standard ISO 11654 and US standard ASTM C 423.  
 Messungen nach der Internationalen Norm ISO 11654 und der US-Norm ASTM C 423.

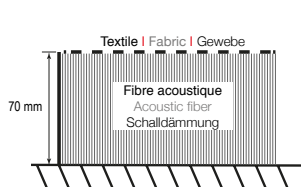

**NRC = 0.95**  
**SAA = 0.98**  
 $\alpha_w = 1.0$

**classe - class - Klasse: A**

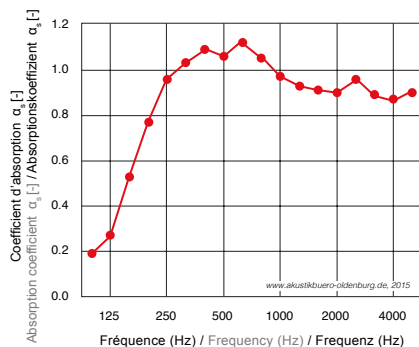

Arch. : M-OFIS Architecture





Réalisation : Building & Engineering et CDC



Arch. : Gensler



Ach. : Dalena Cermakova

# Barrisol®

## Reflet Laqué®

### Lacquered Reflection

### Die lackierte Lichtreflexion



Centre affaire Henri IV



Radisson hôtel

La toile Barrisol® Reflets Laqués® est un produit incontournable de la gamme Barrisol®. Elle habille depuis des années les habitations et les lieux les plus prestigieux. La gamme de plus de 50 coloris, permet d'agrandir une pièce et de lui donner une atmosphère unique. Choisir un plafond Barrisol® Les Reflets Laqués®, c'est choisir l'assurance d'un plafond qui vous reflète et qui est garantie sans fissure. Disponible en version acoustique : A15, A20, A30 et A40.

Barrisol®'s membrane lacquered reflect is an essential product within the Barrisol® collection. Over the years, this membrane has coated some of the most prestigious locations across the globe. The collection which contains over 50 different types of colours creates the illusion of a bigger room and provides a unique atmosphere. Choosing Barrisol® Les Reflets Laqués® leads to choosing for the guarantee of an unbreakable ceiling. Available in acoustic version: A15, A20, A30 and A40.

Die Folie Barrisol® Les Reflets Laqués® ist ein unwiderstehliches Produkt des Sortiments Barrisol®. Seit Jahren dient es den angesehensten Räumen als Verkleidung. Über 50 Farbtöne stehen zur Verfügung, um den Raum optisch zu vergrößern und in eine einzigartige Atmosphäre zu tauchen. Wenn Sie sich eine garantiert rissfreie Decke mit Spiegeffekt wünschen, ist Barrisol® Les Reflets Laqués® ist die richtige Wahl. Erhältlich in der Akustikversion: A15, A20, A30 und A40.



Arch. : COarchitecture





VIDEO



Design : Hakan Kùlahçı/Art Mim

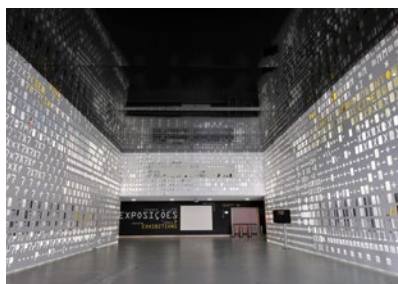

Ach. : João Luis Carrilho



Réalisation : Andrzej Lorens PLAFOND S.C.



Arch. : Marek Deyl & Jan Šesták



Arch. : Ron Arad



Arch. : RAD



Réalisation : Barrisol®  
Métal argenté - Silver metal - Metall Silber



Réalisation : Construction CRD  
Métal argenté - Silver metal - Metall Silber



Arch. : Millenum Construction  
Métal argenté - Silver metal - Metall Silber

# Barrisol®

## Les Metals® Metals Metal



Assas cafeteria

Barrisol® propose une gamme de finition métal en version argenté, fleur de métal, vert métal, laiton, rose métal pour réaliser tous vos projets, aussi bien pour des projets en forme 3D, acoustique, imprimé ou encore en Perfodesign. L'avantage de cette solution, associée aux qualités des produits Barrisol®, réside dans un design unique, un poids très léger, ainsi qu'une accessibilité permanente.

Les toiles de la gamme Les Metals® sont comme le reste de la gamme Barrisol®, elles sont disponibles en version acoustique A15, A20, A30 et A40.

De plus, les toiles de la gamme Les Metals® sont 100% recyclable et utilisent 20 fois moins de matière première que du vrai métal.

Barrisol® offers a finishing touch of silver metal, flowery metal, green metal, milky metal, and rose metal in order to realize all your projects whether they are in 3D form, acoustic or printed version or even perfodesign. The advantage of this solution, combined with the quality of Barrisol®'s products, lies within a unique design, a light weight and a constant availability. The membranes of the Les Metals® range are like the rest of the Barrisol® range, they are available in acoustic version A15, A20, A30 and A40. On top of that, the collection Metals Membrane offers products made of 100% recyclable fabric and uses 20 time less raw material compare to an actual metal.

Barrisol® bietet ein Sortiment mit Metallbeschichtung in den Versionen Silber, Blumenmotiv, Grün Metallic, Messing, Rosa Metallic, um alle ihre Projekte verwirklichen zu können, sowohl ihre 3D-Projekte als auch ihre Projekte in bedruckter Version oder in Perfodesign. Der Vorteil dieser Lösung, die mit den Eigenschaften der Produkte von Barrisol® kombiniert wird, besteht in einem einzigartigen Design, einem geringen Gewicht sowie in einer ständigen Zugänglichkeit. Die Gewebe des Sortiments Les Metals® sind wie das gesamte Sortiment Barrisol® in den Akustikversionen A15, A20, A30 und A40 erhältlich. Darüber hinaus sind die Gewebe des Sortiments Les Metals® zu 100 % recycelbar und benötigen nur ein Zwanzigstel der Rohstoffmenge, die echtes Metall benötigt.



Arch. : MSM design  
Métal argenté - Silver metal - Metall Silber





VIDEO



Arch. : Christian Laquerriere  
Métal laiton - Brass metal - Metall Messing



Arch. : Michal Kutálek  
Vert métal et métal laiton - Green metal and Brass metal -  
Metall Grünes und Metall Messing



Arch. : Studio Plus  
Métal argenté - Silver metal - Metall Silber



Réalisation : PJC Acoustics  
Métal laiton - Brass metal - Metall Messing





Design : Alfons Tost Decoracion - Barcelona

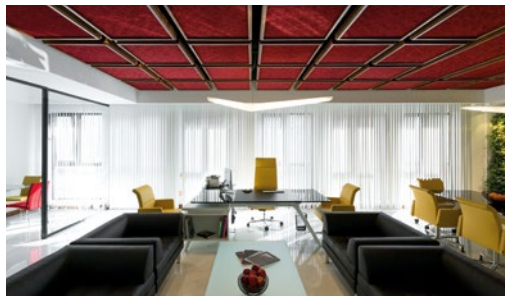

Design : Shirin navab & Farid Mortavazi



Réalisation : Eurasia

# Barrisol®

## Les Daims Ambiance®

### Suede ■ Das Ambiente Wildleder



Sandcrawler Lucas

Pour donner une ambiance chaleureuse, le daim habille vos murs et vos plafonds. Le daim s'adapte aussi très bien pour les forme 3D. Toute la gamme Barrisol® Daims Ambiance® est disponible en version acoustique dans les perforations A15, A20, A30, A40. Il est également possible d'intégrer en complément de la fibre optique, pour un résultat unique ou bien de l'imprimer. La toile Barrisol® Daims Ambiance® peut être combinée à d'autres finitions Barrisol® : translucide/miroir ou encore satiné/translucide.

In order to provide a cosy atmosphere, the Suede suits your wall and ceiling. The suede also adapts very well for 3D shapes. All of the Suede Barrisol® collection is available in an acoustic version with the perforations A15, A20, A30 and A40. It is also possible to integrate a complementary of optical fiber system in order to obtain a unique or printable result. The membrane Barrisol® Daims Ambiance® can be associated with other Barrisol® finishing touches: translucent/mirror or satin/ translucent.

Wenn Sie Ihren Räumen eine gemütliche Atmosphäre verleihen wollen, ist Wildleder die ideale Wand- und Deckenverkleidung. Es passt sich auch hervorragend an 3D-Formen an. Das gesamte Sortiment Barrisol® Daims Ambiance® ist in Akustikversion mit den Perforationen A15, A20, A30 und A40 erhältlich. Um ein einzigartiges Erscheinungsbild zu erzielen, kann es mit Glasfaser kombiniert oder auch bedruckt werden. Das Gewebe Barrisol® Daims Ambiance® kann mit anderen Ausführungen von Barrisol® kombiniert werden: Transluzent/Spiegeleffekt oder auch Seidenglanz/Transluzent.



Arch. : Aedas Architects



Arch. : Samad Gashov



Arch. : Erginoğlu & Çalışlar Architecture  
Daims gris, Translucide, Satiné vert - Gray suede, Translucent, Green satin - Grau beflockt, lichtdurchlässig, grün satiniert



Arch. : Kurtul Erkmek/KG Mimark  
Combinaison de toile miroir, de toile translucide « Athéna » et de toile daim - Combination of mirror membranes, "Athena" translucent membranes and suede membranes  
Kombination aus Spiegelfolie, lichtdurchlässiger Folie „Athéna“ und beflockter Folie





Design : Descines

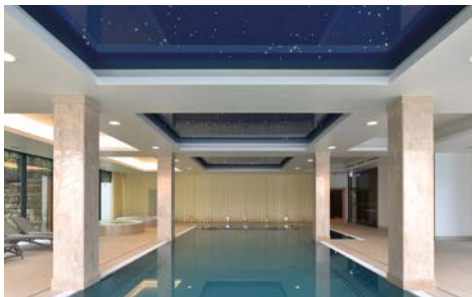

Arch. : Konrad Loesh



Arch. : SARL Béatrice Oréal

# Barrisol®

## Fibres Optiques

## Fiber Optics

## Glasfaserlösungen

Ramada Plazma  
Izmit

Créer une constellation sur votre plafond. Barrisol® Fibres Optiques vous propose de sublimer votre éclairage avec ses différentes finitions et possibilités de décors. Grâce à une impression numérique de haute qualité dans laquelle sera insérée plusieurs brins de fibres optique, votre plafond se transformera en un ciel étoilé.

Create a galaxy on your ceiling. Barrisol® Fiber Optics offers to enhance your lighting with different finishes and possibilities of scenery. Thanks to a high definition digital printing in which will be inserted several optical fiber strands, your ceiling will turn to a stary sky.

Kreieren Sie eine Galaxie auf Ihre Decke. Barrisol® Glasfaserlösungen bieten Ihnen eine breite Auswahl an unterschiedlichen Beleuchtungsformen auf verschiedenen Oberflächen um einzigartige Szenarien zu schaffen. Die Kombination eines hochauflösenden Digitaldrucks mit Galsfaserlichtleiter verwandelt Ihre Decke in einen Sternenhimmel.



Réalisation : Barrisol®





VIDEO



Arch. : Bontinck



Arch. : Edoardo Corvaia

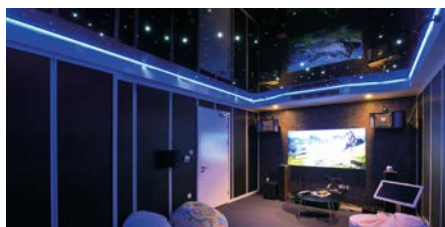

Architecte : HTT Creative

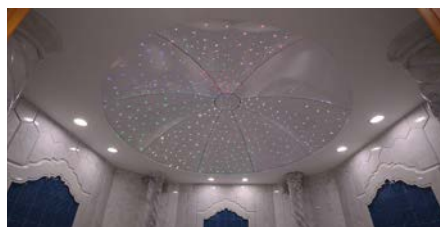

Arch. : Hakan Kulahçi



Réalisation : Barrisol®



Arch. : M. Da Rocha St. J.P Technique



Arch. : Işlay Gençer



Réalisation : Barrisol®

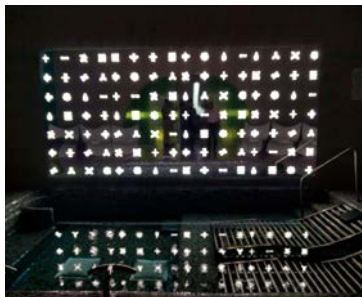

Réalisation : Barrisol®



Arch. : Levent Kuruşçu



Réalisation : Barrisol®

# Barrisol® Perfodesign®



Ikea Loule

Barrisol® Perfodesign® créé le décor qui vous enchante, nous perforons les toiles Barrisol® selon le design que vous avez choisi. Les toiles Barrisol® Perfodesign® peuvent être rétroéclairées en combinant une toile perforée et une toile translucide, qui transmettra la lumière de votre choix par les perforations. Vous pouvez choisir tous types de motifs pour vos perforations : rond, carré, triangle, ovale et toutes autres formes. Vous pouvez également, grâce aux perforations, créer un texte rétro-éclairé. Les toiles peuvent également être imprimées.

With Barrisol® Perfodesign®, you have the possibility to create a universe of your own, we perforate the membrane according to the design you have chosen. The perforation can simply be done on a Barrisol® membrane or can be back-lighted by combining a perforated membrane to a translucent membrane which will transmit the light of your choice through the perforation. You can choose all types of patterns for your perforations: round, square, triangle, oval and all other shapes. You can also, thanks to perforations, create a text backlit. The membranes can be printed.

Barrisol® Perfodesign® bietet Ihnen die Raumgestaltung, die Sie glücklich macht. Wir perforieren die Barrisol® Spannfolie mit dem Design, das Sie ausgesucht haben. Die Gewebe Barrisol® Perfodesign® können hinterleuchtet werden, indem ein perforiertes Gewebe mit einem transluzenten Gewebe, das das Licht Ihrer Wahl durch die Perforationen überträgt, kombiniert wird. Für die Perforationen haben Sie die Wahl zwischen allen Arten von Motiven: Kreise, Quadrate, Dreiecke, Ovale und alle anderen Formen. Mithilfe der Perforationen können Sie auch einen hinterleuchteten Text gestalten. Ebenso können die Gewebe bedruckt werden.



Réalisation : Barrisol®

Perfodesign avec toile Reflet laqué® et translucide - Perfodesign with membrane "Reflet laqué®" and translucent - Perfodesign mit "Reflet laqué®" und transluzent Gewebe





Arch. : BDP London & CPU Retail Architects LDA  
 Toile "Reverso 1" (X1055) perforée - Membrane "Reverso 1" (X1055) perforated - Gewebe "Reverso 1" (X1055) perforiert

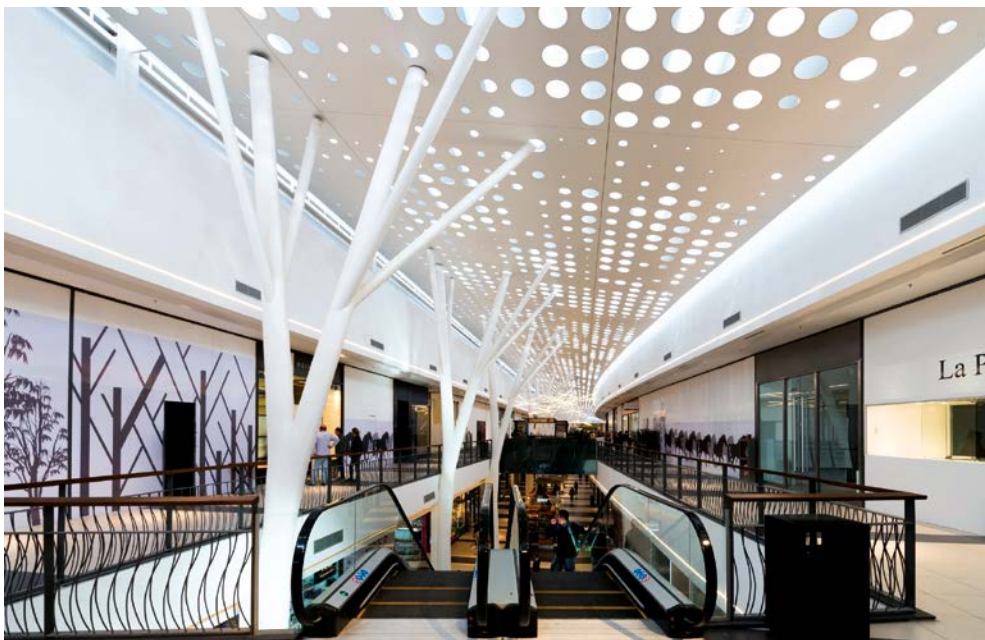

Arch. : PFZ Architectos  
 Toile "Reverso 1" (X1055) perforée - Membrane "Reverso 1" (X1055) perforated - Spannfolie "Reverso 1" (X1055) perforiert







Arch. : A. Di Mattia

# Barrisol® Creadesign®



Barrisol CreaDesign® est une innovation en matière de finition. Le flockage de motifs en daim sur les toiles Barrisol®, sur mesure selon votre création, apporte une perception visio-tactile à la toile. Déjà 8 motifs sont applicables en plus de votre propre création !

Associée à Barrisol Lumière® et Lumière Color® la gamme Barrisol Creadesign® Lumière® permet de créer les ambiances les plus originales.

Barrisol CreaDesign® is an innovative finish. The flockage of patterns in brushed suede on Barrisol® membranes brings a visio-tactile perception. More than 8 motives are available in addition to your own designs ! We can realize your design pattern by exact measurements on your creation. Associated with Barrisol Lumière® and Lumière Color®, CreaDesign® allows the creation of the most original atmospheres and moods in your interior space.

Barrisol CreaDesign® ist eine innovative Oberflächengestaltung. Das Beflocken der Barrisol® Spanndecken mit Veloursmaterial gibt Ihrer Creation einen zusätzlichen speziellen visio-taktilen Oberflächeneindruck. Es stehen bereits 8 Motive zur Verfügung, die Sie zusätzlich zu Ihren eigenen Projekten verwenden können! Ihr Design - maßgeschneidert für Ihre Räume!

In Kombination mit Barrisol Lumière® und Lumière Color® bietet das Programm Barrisol CreaDesign® Lumière® die Möglichkeit, noch originellere Einrichtungen zu schaffen.



Arch. : Nihal Sezgi

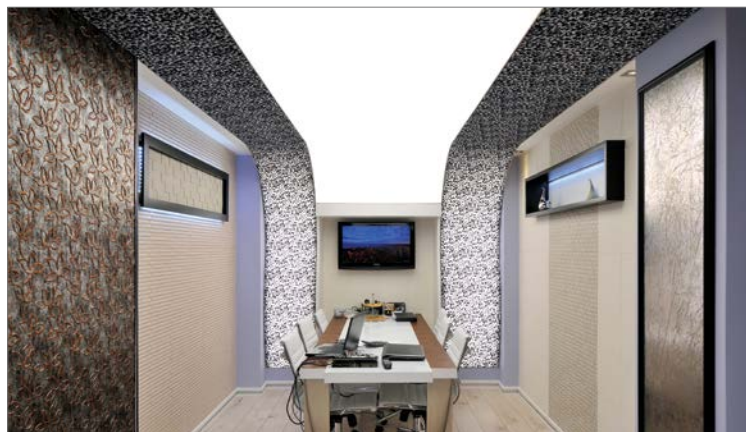

Arch. : Barrisol® Izmir/Turkey - Yezmir Yapi show-room



BCA Zebra

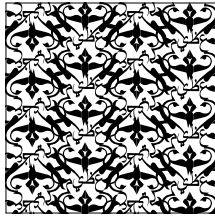

BCO Orient



BCD Floral



BCF Spirale

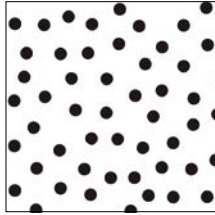

BCG Dot



BCH Zen



BCJ Zebra



Votre motif...  
Your pattern...  
Ihr Muster...

**+ couleurs de flocage et finitions de toile\***

**+ flocking colours and sheet finishes\***

**+ Beflockungsfarben und Deckenoberflächen \***

\* Liste des couleurs et finitions à consulter sur [www.barrisol.com](http://www.barrisol.com) - \*You can view the list of colours and finishes on [www.barrisol.com](http://www.barrisol.com)  
\*Liste der Farben und Obeflächen abrufbar unter [www.barrisol.com](http://www.barrisol.com)

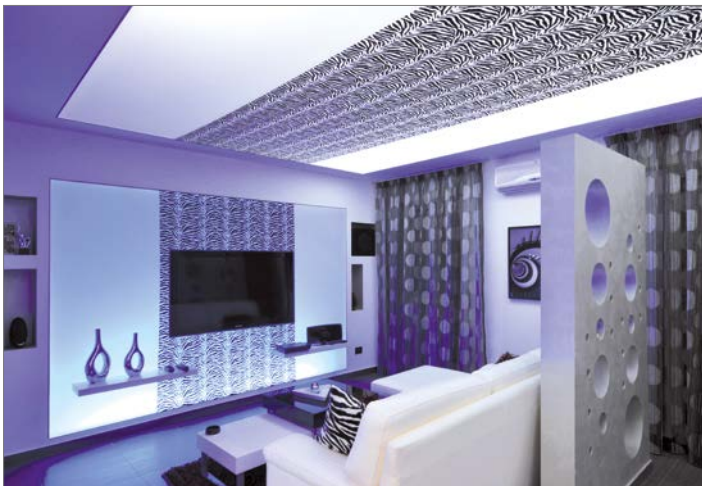

Arch. : Eduardo Corvaia

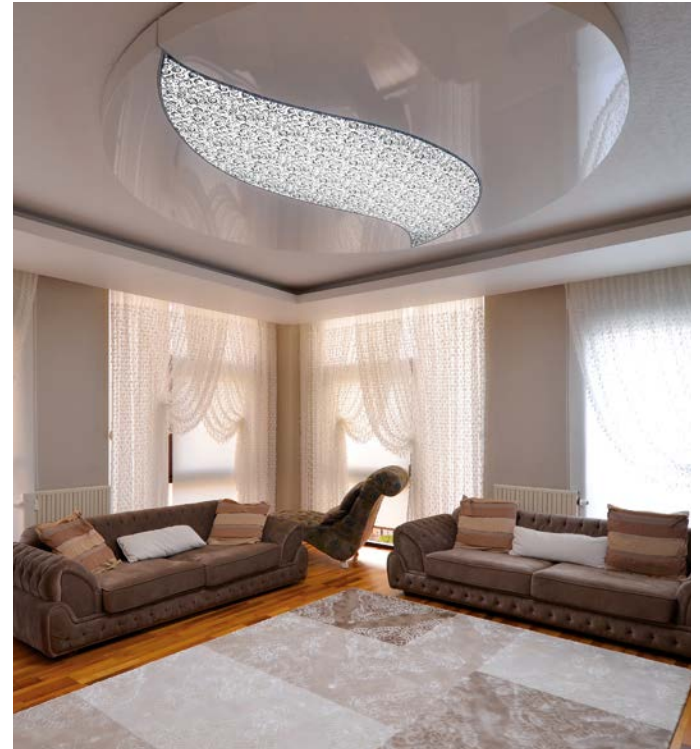

Réalisation : Barrisol®



Arch. : Barrisol® Finland





Design : Studio Massaud



Design : Dodecaedro



Design : Manuel Galvez

## Barrisol®

# Stands & structures événementielles Exhibition stands and event structures system Messestände und Events



Stand Presbeton

FOPE  
Baselworld

Barrisol® Stand associe les structures Syma® avec ses toiles pour la réalisation de structures événementielles. Avec les nombreuses solutions Barrisol®, tous types de stands peuvent être conçus des plus simples au plus structurés. Les stands conçus en Barrisol® permettent une grande variété de finitions et garantissent une pose et un démontage facilités.

Thanks to Barrisol® Stand associated with the Syma® structures system, event and exhibition stands, from the simplest to the most audacious forms can be realized in a multitude of shapes, sizes and finishes. By utilizing the full Barrisol® membrane range and solutions, almost anything is possible. The advantages of the lightweight of Barrisol® solutions and the fast installation times make Barrisol® the perfect choice.

Barrisol® Stand kombiniert die Konstruktionen Syma® mit den Spanndecken und erzeugt so Formen für Messestände. Mit zahlreichen Lösungen von Barrisol®, ist die Umsetzung jedes Designs, von den einfachsten bis zu den kompliziertesten Strukturen möglich. Die von Barrisol® konzipierten Konstruktionen bieten eine große Vielfalt an Oberflächen und garantieren eine schnelle und einfache Montage und Demontage.



Arch. : Grisdainese





Arch. : Michal Kutálek



Arch. : Estudio Blaustein & Asoc. S.R.L.



Design : Ferdi Niederstein & Yves Meyer



Arch. : Karim Azzabi - Studio Design Network



Arch. : Asastudio - Réalisation : Barberis Impianti



Réalisation : Intermedio



Musée du Papier Peint



Ref.: BAE - Light & Flower



Réf.: 1880 Alsace - Ref.: 1066.40



Ref.: Danneels - Arch.: Lineos



**artolis®** by BARRISOL®

Toile textile grande largeur jusqu'à 5 m ■ Textile membrane width up to 5 m ■ Textilgewebe bis 5 m Breite



Barco



Private House



Quang Ninh  
Museum



Private House

Pour répondre aux exigences de l'architecture d'intérieur, Artolis® offre un ensemble de solutions techniques en grande largeur (jusqu'à 5 m sans soudure ni couture). Les revêtements Artolis®, d'une très grande résistance aux chocs et aux impacts, sont parfaitement adaptés pour des applications murales. Artolis® se pose à température ambiante et répond à toutes les normes en vigueur.

Grâce aux technologies d'impression numérique haute définition, vos murs et vos plafonds peuvent être imprimés, soit avec vos propres photos (qualité minimum 300 dpi à 1/10<sup>th</sup> du format final), soit parmi la plus vaste collection d'images mise à votre disposition : Les Éditions Barrisol®.

To meet interior design requirements, Artolis® offers a set of technical solutions in a wide width (up to 5m: without welds or sewing). Artolis® coatings are shock and impact resistant but are also perfectly adaptable for wall applications and can be installed in an ambient temperature and respects all applicable standards.

Thanks to HD digital printing technologies, your walls and ceilings can be printed with your own pictures (min. quality 300 dpi, 1/10<sup>th</sup> from the final format). They can be also printed thanks the Barrisol® Editions, the largest pictures collection.

Um den Ansprüchen der Innenarchitektur zu entsprechen, bietet Artolis® technische Lösungen mit einer Breite bis zu 5m ohne Schweißstelle oder Naht. Die Artolis® Textilien, welche ein hoher Widerstand gegen Stöße und Einschläge hat, ist für Wandverkleidungen perfekt geeignet.

Artolis® wird auf Raumtemperatur gespannt und entspricht alle gültige Normen.

Dank der digitalen Druck Technologien können wir Ihre Wände und Decke entweder mit Ihren eigenen Bildern (300 dpi min.; 1/10<sup>th</sup> des Endformats) oder mit der umfassende Bilder Sammlung „Éditions Barrisol®“ bedrucken.



Arch.: Jaspers-Eyers & Partners

VIDEO



Performances acoustiques  
Acoustic performance  
Akustische Leistungen

**NRC = 0.95**  
**SAA = 0.98**  
 **$\alpha_w = 1.0$**

**classe - class - Klasse: A**

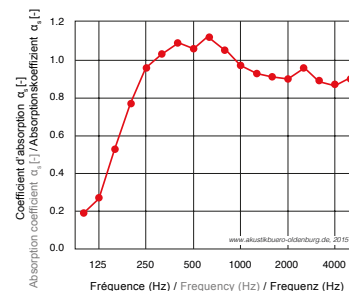





Arch. : Frédéric Morin



ref. City drawings - Les toits de Paris



Arch. : Javier Zueco Sánchez - Lorenzo Tomás Gabarrón



Showroom Kordekor



Cinéma de Blaye - Arch. : adh (Doazan + Hirschberger & associés)



Design : Zülfikar YILDIRIM

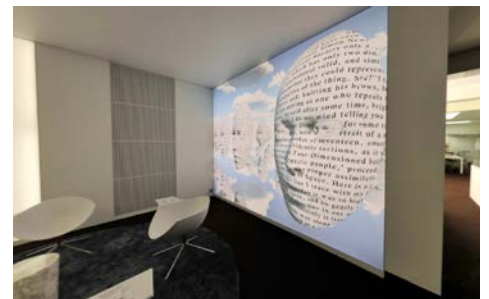

Showroom Kordekor





Arch. : Dr Salvador Perez Arroyo



Arch. : M-OFIS Architecture



Réalisation : Barrisol<sup>®</sup>



Arch. : Basic Architects



Arch. : Ignacio Mendez CBRE



Arch. : Reform





Réalisation : Barrisol®



# artolis® Bi-stretch® by BARRISOL®

La toile Artolis® Stretch Bidirectionnel et transonore ■ The bi-directional, transonic Artolis® Stretch ■  
Artolis® Stretch Bidirectionnel - bi-elastisch und schalldurchlässig

La toile Artolis® Stretch Bidirectionnel et transonore est constituée d'une maille extensible dans les deux sens d'une largeur exceptionnelle de 4,5m qui se tend à plus de 5m.

Cette toile est parfaitement adaptée pour les salles de cinéma, l'isolant acoustique absorbe le son comme si il n'y avait pas de revêtement devant. Le tissu est transonore et permet de restituer le son des haut-parleurs placés à l'arrière. Sa très grande laise permet de traiter des pans de mur en entiers sans raccord. La toile se pose avec les profilés et les harpons de la gamme Artolis® et permet de faire des formes en 3D.

Classement au feu : B-s1, d0

The bi-directional, transonic Artolis® Stretch is constituted an extensible weave in both directions, in an exceptional width of 4.5m which can be stretched to 5m.

This fabric is perfectly suited to cinema auditoriums - the soundproofing absorbs as well as if there was no covering in front of it. The fabric is transonic and transmits sound beautifully from speakers at the back.

As it is exceptionally wide, you can cover wide swathes of wall without the need for a connection. Install this fabric using the Artolis® profiles and harpoons, which let you create 3D shapes.

Fire classification: B-s1, d0

Artolis® Stretch Bidirectionnel - bi-elastisch und schalldurchlässig besteht in einem in zwei Richtungen dehnbaren Gewebe, das in der außergewöhnlichen Breite von 4,5 m zur Verfügung steht und auf mehr als 5 m Breite gespannt werden kann.

Dieses Material ist perfekt geeignet für Kinosäle, die Schallsolierung absorbiert den Ton, als gäbe es davor keine Bespannung. Das Gewebe ist schalldurchlässig und erlaubt es, den Ton der dahinter montierten Lautsprecheranlage perfekt wiederzugeben. Die sehr große Maschinenbreite der Bahnen erlaubt es, ganze Wandflächen ohne Stoßkanten zu bespannen. Das Material wird mit Profilen oder Harpunen der Reihe Artolis® verlegt und erlaubt die Gestaltung von Formen in 3D.

Brandverhalten : B-s1, d0



Arch. : Pina Maugeri et Joern Brandmeyer





Arch. : Lineos



Arch. : Lineos Ontwerpbureau



Ref. : EBCT « Birdy Roses »



Ref. : EBCT « Pink jacquart & Puttis »



Ref. : EBCT « Birdy in Sky Roses »

# Chantal Thomass for **Barrisol®**

Du Chic & Glamour pour nos murs et plafonds !  
 Style and glamour for your walls and ceilings!  
 Schick und Glamour für unsere Wände und Decken!



Catalogue  
Chantal Thomass



Dépliant  
Chantal Thomass

On ne présente plus Chantal Thomass. Icône du glamour, elle cache derrière sa frange noire légendaire une créativité prolifique. Connue pour la lingerie qu'elle a été la première à faire défiler sur les podiums, Chantal Thomass joue avec les codes de la féminité dans une élégance reconnaissable entre toutes. La mode est son domaine de prédilection, mais cette passionnée de décoration se régale également dans l'exploration d'autres domaines qu'elle signe de son univers singulier. De la décoration d'hôtels à la création d'une collection de murs et de plafonds tendus, il n'y avait qu'un pas, qu'elle franchit avec jubilation en partenariat exclusif avec Barrisol®.

Who has not heard of Chantal Thomass? She is a glamour icon, whose legendary dark fringe hides her prolific creativity. Chantal Thomass was the first lingerie designer to put her creations on the catwalk, and she plays with the grammar of feminineness with unmistakable elegance. Fashion may be her main interest, but she is also

passionate about decoration and loves to explore other areas and mark them with her unique stamp. The move from hotel decoration to the creation of a collection of stretch ceilings and walls only made sense, and she has made it with her usual exuberance through an exclusive partnership with Barrisol®.

Unnötig Chantal Thomass vorzustellen. Eine Ikone der Glamourwelt. Hinter ihrem legendären schwarzen Pony verbirgt sich unerschöpfliche Kreativität. Bekannt für Dessous – erstmals von ihr auf den Laufsteg gebracht – bespielt Chantal Thomass die Normen des Femininen mit wiedererkennbarer Eleganz. Die Mode ist ihre bevorzugte Spielwiese. Gleichwohl vergnügt sich die leidenschaftliche Dekorateurin auch in der Erforschung anderer Bereiche, denen sie ihre einzigartige Handschrift verleiht. Von Hoteldekor bis hin zur Schaffung einer Kollektion von Wand- und Deckenbespannungen war es nur ein Schritt. Sie nimmt ihn jubelnd in exklusiver Partnerschaft mit Barrisol®.



Photographie : Jo Zhou



Ref. : EBCT - Délicats butterflies »  
Ref. : EBCT Delicats Butterflies / Ref. : EBCT „Zarte Schmetterlinge“



Ref. : EBCT - Folles moulures »  
Ref. : EBCT \* Folles moulures \* / Ref. : EBCT „Versponnene Stuckaturen“



Ref. : EBCT - Words eye & PinkSky »  
Ref. : EBCT Words eye & PinkSky / Ref. : EBCT „Words eye & PinkSky“



Ref. : EBCT - Explosion de bijoux »  
Ref. : EBCT \* Explosion de bijoux \* / Ref. : EBCT „Schmuckexplosion“



Ref. : EBCT - Butterflies in the sky »

Grâce à la finesse de l'impression numérique haute définition réalisée dans les ateliers Barrisol® Normalu®, toutes les audaces sont permises. Le mixage de gravures anciennes, de peintures issues du fond de la Réunion des Musées Nationaux, et de lignes graphiques donne une modernité incomparable aux décors.

With the fineness of the high-definition digital printing techniques used in the workshops of Barrisol® Normalu®, the sky is the limit. By mixing antique engravings, paintings from the collections of the National Museums Alliance (RMN) and graphic lines, the decors become incomparably modern.

Dank der Finesse des hochauflösenden Digitaldrucks aus den Ateliers von Barrisol® Normalu® sind sämtliche Extravaganzen erlaubt: die Mischung aus alten Gravuren und Gemälden aus dem Bestand des Zusammenschlusses der französischen Nationalmuseen (RMN) mit graphischen Linien, die den Dekors eine unvergleichliche Modernität verleihen.





Collection « La nature » réf. : EBKE-046



Mur Artolis® imprimé Collection « Zen », réf. : EBKE-021



Collection « Les saisons » réf. : EBKE-012



Mur Artolis® imprimé collection « Le bonheur », réf. : EBKE-026

# Keishu Kawai for **Barrisol®**



Catalogue  
Keishu Kawai



Dépliant  
Keishu Kawai

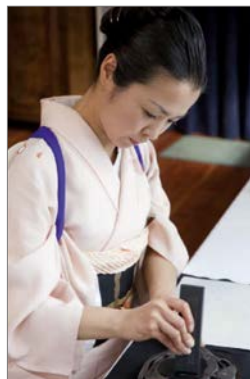

Aujourd'hui, alsacienne d'adoption, sur cette terre particulièrement riche d'échanges Franco-Japonais, Maître Keishu Kawai se consacre à l'art de la calligraphie, et développe des collections de plus en plus uniques, apportant à la calligraphie traditionnelle du pays du soleil levant, une touche de modernité.

La sensibilité de l'encre sur le papier, l'élégance des traits, calligraphiés avec justesse et élégance ont donné à cette artiste insatiable des envies de grands formats. La rencontre de Maître Keishu Kawai avec la société Barrisol® a permis de réaliser ce rêve au travers d'une collection de calligraphies, dédiées à la décoration d'intérieur.

Ainsi, murs et plafonds peuvent se parer de ces dessins délicats qui apportent pureté et élégance dans l'architecture classique ou contemporaine.

In this region that is particularly rich in Franco-Japanese exchanges, Master Keishu Kawai, who has become an honorary Alsatian, is dedicating herself to the art of calligraphy and is developing increasingly unique collections, endowing the traditional calligraphy of the land of the rising sun with a touch of modernity.

The sensitivity of the ink on the paper, the elegance of the brush strokes, which are delicately and accurately applied, have given this artist an insatiable appetite for large format

work. Master Keishu Kawai's meeting with the company Barrisol® made it possible to achieve this dream through a calligraphy collection designed specifically for interior decoration.

Walls and ceilings can be enhanced with these delicate designs that add purity and elegance to classical or contemporary architecture.

Die Meisterin Keishu Kawai ist Wahl-Elsässerin und damit Teil dieser besonders lebendigen Welt der franko-japanischen Austauschbeziehungen. Heutzutage widmet sie sich der Kunst der Kalligraphie und entwickelt Kollektionen, die immer einzigartiger werden. Damit verleiht sie der traditionellen Kalligraphie aus dem Land der aufgehenden Sonne einen Hauch von Moderne.

Die Empfindlichkeit der Tinte auf dem Papier sowie die Eleganz der Striche, die mit Genauigkeit und Eleganz kalligraphiert wurden, haben dieser unersättlichen Künstlerin das Verlangen für die großen Formate gegeben. Durch das Treffen der Meisterin Keishu Kawai mit dem Unternehmen Barrisol® konnte dieser Traum im Rahmen einer Kollektion von Kalligraphien, die der Raumgestaltung gewidmet sind, realisiert werden.

So können Wände und Decken mit diesen schwierigen Zeichnungen geschmückt werden, die der klassischen oder zeitgenössischen Architektur Reinheit und Eleganz verleihen.



Collection « Les saisons » réf. : EBKE-009



Réf. : EBKE-011 imprimée sur un mur tendu Artolis®



Mur imprimé Artolis® collection « La vie »,  
réf. : EBKE-004.



Collection « Le bonheur », réf. : EBKE-034.

La calligraphie japonaise apporte une touche d'élégance à un intérieur.

Grâce aux revêtements Barrisol® en murs et en plafonds, et aux calligraphies de Maître Keishu Kawai, votre décor devient une véritable œuvre d'art.

Japanese calligraphy adds a touch of elegance to any interior.

Thanks to Barrisol® wall and ceiling coverings, and the calligraphy of Master Keishu Kawai, ensure that your decor is a real work of art.

Mit der japanischen Kalligraphie gelangt ein Hauch von Eleganz in einen Innenraum.

Dank Barrisol®-Verkleidungen auf Wänden und an Decken, die aus ihrer Dekoration ein wahrhaftes Kunstwerk machen.



Planche d'impression Plombine - Lead-based printing block - Relief-Druckplatte aus Blei



Ouvrage de la collection  
Work from the collection - Werk der Sammlung



Planche d'impression bois - Wood-based printing block - Relief-Druckplatte aus Holz



Création Barrisol®  
Barrisol® Creation - Entwicklung von Barrisol®

## Barrisol®

# Musée de l'Impression Sur Étoffes The Museum of Printed Textiles Das Stoffdruckmuseum

MUSÉE DE L'IMPRESSION SUR ÉTOFFES  
M U L H O U S E



Catalogue  
MISE 1



Catalogue  
MISE 2



Dépliant  
MISE

Grâce à un partenariat exclusif avec le Musée de l'Impression sur Étoffes (M.I.S.E.) de Mulhouse, Barrisol® vous donne accès à une collection unique au monde, riche de plus de 6 millions de visuels tirés du plus important fond d'archives textile du monde. Avec déjà 6 000 documents numérisés en haute définition, Barrisol® vous propose d'imprimer sur des toiles tendues les motifs des textiles conservés au musée depuis 1883. Le M.I.S.E. et Barrisol® vous donnent accès à 250 ans d'histoire de l'impression sur textile. Plafonds et murs tendus, panneaux acoustiques ou lumineux, les possibilités de mise en valeur de ces motifs peuvent se décliner dans les différentes solutions techniques issues du savoir-faire Barrisol®.

The exclusive partnership with the Musée de l'Impression sur Étoffes (M.I.S.E.) of Mulhouse enables Barrisol® to give you access to a one of its kind collection, including more than 6 millions visuals from the largest archive of textiles in the world. With 6,000 documents scanned in high definition, Barrisol® gives you the opportunity to reprint on stretched sheets the textile patterns that have been kept at the museum since 1883. The M.I.S.E. and Barrisol® open the doors to 250 years of textile printing history. Barrisol®'s expertise makes it possible to highlight these patterns on stretch ceilings and walls, and on acoustic or luminous panels.

Dank einer exklusiven Partnerschaft mit dem Musée de l'Impression sur Étoffes (M.I.S.E.) in Mulhouse, gewährt Ihnen Barrisol® Zugriff auf eine weltweit einzigartige Kollektion von mehr als 6 Millionen Motiven aus dem umfangreichsten Archiv an textilem Kulturerbe in der Welt. Es wurden bereits 6 000 Dokumente in hoher Auflösung digitalisiert und Barrisol® bietet Ihnen an, diese textilen Motive, die seit 1883 im Museum aufbewahrt werden, auf Ihre Spanndecken zu drucken. Das M.I.S.E. und Barrisol® bieten Ihnen Zugang zu einer 250-jährigen Geschichte des Textildrucks. Spanndecken und -wände, Lärmschutz- oder Leuchtpanelee... die Möglichkeiten der Verwendung dieser Motive anhand der vielen verschiedenen technischen Lösungen auf der Basis des Knowhows von Barrisol® sind mannigfaltig.





Motif utilisé en version surdimensionnée / Motif used as oversized version / Motif, das auf überdimensionierter Version verwendet wird

1898 Alsace - réf. : 1538.42-3.

1898 Alsace - réf. : 1538.42-3



1934 Mulhouse - réf. : 1371.1-4618.  
Coloris rehaussés et utilisé en format surdimensionné  
Colours enhanced and used in oversized format  
Verstärkte Farbgebung und in überdimensioniertem Format verwendet



1880 Alsace - réf. : 964p45.  
Surdimensionnée - Oversized - Überdimensioniert



1924 France - réf. : 1337.3-61-2.  
Déclinaisons de coloris autour de ce tissu à fleurs Art Déco  
Colour variations around this floral Art Deco fabric  
Variationen von Farbgebungen um diesen geblühten Art-Deco-Stoff herum



Manufacture du Landy France - réf. : 9762



Manufacture Dufour Leroy Paris - réf. : 10143

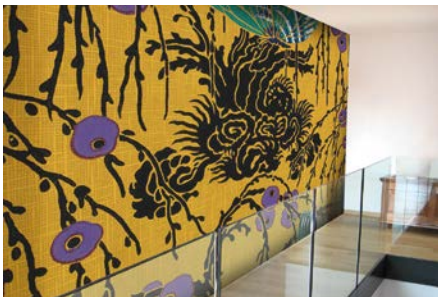

Manufacture Leroy France - réf. : 9707



Dominotiers les Associés Paris - réf. : 9722

# Barrisol®

## Musée du Papier Peint

### Wallpaper Museum ■ Tapetenmuseum

**MUSÉE DU PAPIER PEINT**  
 R I X H E I M - A L S A C E  
 ■ TAPETENMUSEUM ■ MUSEUM OF WALLPAPER



Catalogue  
MPP



Dépliant  
MPP

Barrisol® est fier de vous présenter son partenariat exclusif avec le Musée du Papier Peint pour son 4<sup>e</sup> tome des Éditions Barrisol®. Ces archives, sélectionnées et restaurées avec soin, sont aujourd'hui prêtes à décorer vos intérieurs ou projets les plus beaux. Imprimés en millions de couleurs grâce à des imprimantes numériques de dernière génération au sein même de son site, les revêtements mats ou laqués, satinés ou textiles parent les murs et les plafonds de motifs historiques d'une extraordinaire modernité.

Barrisol® is proud to present its exclusive partnership with the Wallpaper Museum in the fourth volume of the Editions Barrisol®. These archives were carefully selected and restored and are now available for your interior decorating projects and design schemes. Each historic design can be printed in millions of different colours using the latest generation digital printers at Barrisol®'s local production site and given mat, lacquered, satin or textile finishes that add an extraordinary modern touch to your walls and ceilings.

Barrisol® präsentiert Ihnen heute voller Stolz, mit dem 4. Band der Editions Barrisol®, seine exklusive Partnerschaft mit dem Tapetenmuseum. Diese sorgfältig ausgewählten und virtuell restaurierten Archive stehen für Sie bereit um Ihre Innenwände oder Ihre schönsten Projekte auszuschnücken. Die matten oder lackierten, satinierten oder textilen Beläge, die mit digitalen Druckern der jüngsten Generation; direkt vor Ort; in Millionen Farben gedruckt werden, schmücken die Wände und Decken mit historischen Motiven, die ausgesprochen modern sind.

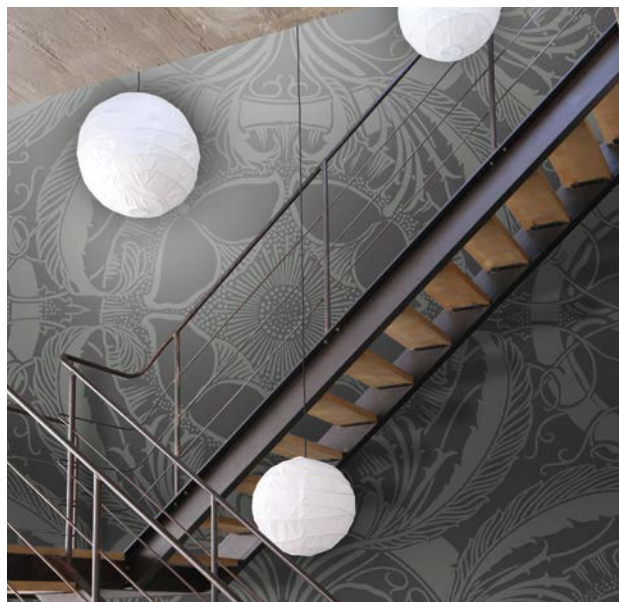

Réf. : 9650 - Manufacture Sanderson, Londres, Royaume-Uni - 1894  
 « The Poppy ceiling » recolorisé dans les tons gris - "The Poppy Ceiling" recoloured in shades of grey - „The Poppy ceiling“ in Grautönen nachgefärbt





Réf. : 10160 - Manufacture Desfossé à Paris - 1862 - Partie du panoramique « le Brésil » - Section from "Brazil" panorama - Teil der Panoramaaufnahme „Brasilien“

Composé de 20 lés de papier peint, ce panoramique du Brésil atteint 20 mètres de large par 4,70 mètres de hauteur dans une définition parfaite pour une qualité d'impression extraordinaire. Adapté aux dimensions de vos projets, cet incroyable décor invite à la rêverie et à l'évasion.

This panoramic scene of Brazil consists of 20 panels of wallpaper. It is 20 meters wide and 4.70 meters high and boasts perfect definition enabling outstanding printing quality. This incredible decor can be adapted to suit your decorating scheme, inviting reverie and escapism.

Sie stellen eine französische Spezialität dar und werden erfolgreich ins übrige Europa sowie nach Amerika exportiert. Sie umfassen Ausschnitte aus dem Leben mit Personen, wobei die Natur und die Landschaften als Hintergrund dienen. Die Naturdarstellung ist realistisch, wenn auch vom Menschen idealisiert, und im Lauf der Zeit verschwinden die Personen und lassen der üppigen Natur Platz, die zum Träumen verleitet und der Lust auf Exotik entspricht.



Réf. : 10126 - Manufacture Inconnue, France - 1860 - Unknown manufacturer, France - 1860 - Unbekannte Manufaktur, Frankreich - 1860



Réf. : 10703 - Manufacture Delicourt à Paris - 1860 - Panoramique « Les Quatre âges de la Vie » Manufactured by Delicourt in Paris - 1860. "The Four Ages of Man" Panorama Manufaktur Delicourt in Paris - 1860 - Panoramaaufnahme „Die vier Altersstufen des Lebens“





Réf. : 24519. Labaroche 1908



Réf. : 24537. Labaroche 1908



Réf. : 24534. Châteaux d'Ottrott

# Barrisol® Musée Hansi - Colmar

Dépliant  
Musée Hansi

Plus connu sous le nom de Hansi, Jean-Jacques Waltz a été un artiste alsacien prolifique et éclectique. Réunie aujourd'hui dans un écrin à Colmar, la collection regorge de peintures, aquarelles, eaux-fortes, lithographies, livres ou publicités.

Grâce au partenariat exclusif développé avec la société Barrisol®, créer un décor avec la tendresse bucolique de cette Alsace d'aujourd'hui est désormais possible.

Better known as Hansi, Jean-Jacques Waltz was a prolific and eclectic artist from Alsace. His collection, which has now been brought together in Colmar, includes a large number of paintings, watercolours, etchings, lithographs, books and posters.

Thanks to an exclusive partnership with Barrisol®, you can now create a décor with the idyllic images of that Alsace of the past.

Jean-Jacques Waltz, besser bekannt unter dem Namen Hansi, war ein überaus produktiver und vielseitiger Künstler. Seine nun in Colmar zusammengetragene Sammlung umfasst unzählige Gemälde, Aquarelle, Radierungen, Lithografien, Bücher und Reklamen.

Dank der exklusiven Partnerschaft mit Barrisol® kann künftig eine Dekoration mit der zärtlichen Idylle dieses Elsass von damals geschaffen werden.



Réf. : 24544. Hippoltskirch près de Ferrette





Réf. : 24517



Réf. : 24515



Réf. : 24546



Réf. : 24539



L'automne, vers 1900. Réf. : 24532



Réf. : 24507

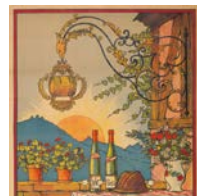

Réf. : 24545



Réf. : 24542



Réf. : 24536



Réf. : 24508

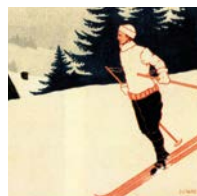

Réf. : 24531



Réf. : 24543



Réf. : 24547



Réf. : 24538. Près de Herrlisheim



RMN - Réf. : 04-500019. Le Voyageur au-dessus de la mer de nuages, XIX<sup>e</sup>, David Friedrich Caspar - Wanderer above the Sea of Fog, 19<sup>th</sup> C., David Friedrich Caspar - „Der Wanderer über dem Nebelmeer, XIX<sup>e</sup>, David Friedrich Caspar“



RMN - Réf. : 95-024205. "La classe de danse", 1875, Edgar Degas - "The Dance Class", 1875, Edgar Degas - „Die Tanzklasse“, 1875, Edgar Degas



RMN - Réf. : 07-520187

**Barrisol®**

Réunion des Musées Nationaux  
National museums Network  
Vereinigung der Nationalmuseen



Réunion  
des Musées  
Nationaux



Catalogue  
RMN



Dépliant  
RMN

Barrisol® vous convie à visiter la plus grande des collections d'images d'art.

Passionnée d'Art mais surtout mécène, la société Barrisol® s'est naturellement tournée vers la Réunion des Musées Nationaux (RMN) pour créer sa toute nouvelle édition liée à l'Art. Grâce à ce partenariat avec le RMN, une sélection de 400 œuvres d'art parmi près de 750 000 conservées dans les musées nationaux et régionaux français sont disponibles à la réalisation de vos décors les plus somptueux.

De la Joconde aux Nymphéas, du Titien à Van Gogh, des Ingres aux arts de l'Orient, les peintures, sculptures ou dessins sont prêts à être intégrés dans vos intérieurs les plus spectaculaires.

Barrisol® invites you to visit the largest collection of artistic images.

Barrisol® has a passion for Art, but the company is also first and foremost a patron of Arts. It is only natural that Barrisol should turn to the "Réunion des Musées Nationaux" (RMN) to create its new edition dedicated to Art. Thanks to this partnership with the RMN, a selection of 400 works, out of the 750,000 that are kept in the national and regional museums, is at your disposal to create the most spectacular of decors.

La Joconde, the Water Lillies, Titien, Van Gogh, Ingres or eastern arts, all paintings, sculptures and drawings can be integrated into your most amazing interiors.

Barrisol® lädt Sie ein zu einer Besichtigung der größten Sammlung von Kunstwerken.

Als Kunstliebhaber, aber vor allem als Mäzen hat sich das Unternehmen Barrisol® ganz natürlich an die Vereinigung der Nationalmuseen, die Réunion des Musées Nationaux (RMN) gewendet, um seine neueste Edition zusammenzustellen. Dank der Partnerschaft mit der RMN, steht eine Auswahl von 400 Stücken zur Verfügung, die aus den 750 000 Kunstwerken ausgewählt wurden, die in den nationalen und regionalen französischen Museen aufbewahrt werden und die jetzt für die Realisierung Ihrer prächtigsten Inneneinrichtungen bereit stehen. Von der Mona Lisa bis zu den Seerosen, von Tizian bis Van Gogh, von Ingres bis zu den Künsten des Orients, stehen Ihnen Gemälde, Skulpturen oder Zeichnungen zur Verfügung, um sich in Ihre spektakulärsten Inneneinrichtungen einzufügen.





RMN - Réf. : 11-564761. « La Joconde, portrait de Mona Lisa », XV, Léonard de Vinci / Réf. : 97-016092. « La Madeleine à la veilleuse », XVII, Georges de la Tour  
 "Portrait of Mona Lisa" - XV - Léonard de Vinci / Ref.: 97-016092. "Magdalene with the Smoking Flame" - XVII - Georges de la Tour  
 „Mona Lisa, Porträt von Mona Lisa" - XV - Léonard de Vinci / Ref.: 97-016092. „Magdalena mit der Öllampe", XVII, Georges de la Tour



RMN - Réf. : 09-527047. « Nymphéas », 1915, Claude Monet - "Water Lilies"- 1915 - Claude Monet - „Seerosen", 1915, Claude Monet

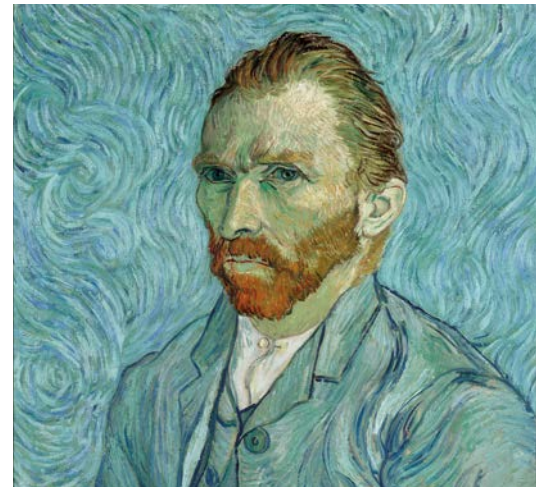

RMN -Réf. : 97-014070. « Autoportrait », 1889, Vincent Van Gogh - "Self portrait", 1889, Vincent Van Gogh - „Selbstbildnis", 1889, Vincent Van Gogh



Réalisation : Barrisol®



Réalisation : Barrisol®



Réalisation : Barrisol®



# Barrisol® Dalrenov®

Solution rénovation ■ Retrofit Solution ■ Renovierungslösungen



Ce système novateur permet la rénovation des dalles de plafonds soit avec la gamme Barrisol®, soit avec la gamme textile Artolis®. Conçue pour s'adapter à la dalle existante, la toile Barrisol® est fixée sur un rail périphérique posé autour des dalles à rénover. Le confort acoustique conféré par les dalles est ainsi conservé. Dalrenov® s'adapte à toutes les surfaces de dalles de plafonds et son système de fixation facilite la pose. Dalrenov® est déclinée dans toutes les couleurs et différentes matières, permettant de rénover un plafond tout en revisitant la décoration, et réaliser les travaux proprement et progressivement. Dalrenov® permet de rénover sans destruction du matériel existant, tout en évitant le transport et le recyclage coûteux. Le système exclusif Barrisol Dalrenov® bénéficie des qualités techniques et environnementales des toiles Barrisol® étiquetées A+, classées BS1-D0 et BS2-D0.

This innovative system allows the renovation of ceiling tiles with either the Barrisol® range or the Artolis® textile range. Designed to adapt to the existing tile, the Barrisol® sheet is fixed on a peripheral rail around the tile which have to be renovated. The acoustic comfort confer by the tiles is maintained. Dalrenov® can adapt to each ceiling tiles surface and its fixing system makes the installation much easier, whichever the location. Dalrenov® is available in all colors and finishes, which allows renovating the ceiling with a new decoration unless major reconstruction works. It avoids expensive transport and recycling. The exclusive Barrisol Dalrenov® system benefits from the technical & environmental qualities of Barrisol® sheets labeled A+ and BS1-D0, BS2-D0 rated.

Dieses innovative System erleichtert die Renovierung von Kassettendecken und gibt Ihrer Decke ein zweites Leben. Das Spanndeckenmaterial von Barrisol® ist so ausgelegt, dass es sich an die vorhandenen Konstruktionen anpassen kann, indem es auf einer Schiene befestigt wird, die rings um die Kassette läuft. So wird auch die Lärmdämmung, die durch die Kassetten erzeugt wird, beibehalten. Dalrenov® passt sich perfekt an alle Deckenplatten an und das Befestigungssystem erleichtert das Verlegen. Dalrenov® steht in allen Farben und unterschiedlichen Materialien zur Verfügung, so dass 250 Oberflächenstrukturen möglich sind. Mit Dalrenov® kann eine Decke renoviert, die Dekoration neu gestaltet und die Arbeit sauber ausgeführt werden. Das exklusive System Dalrenov® nutzt die technischen und ökologischen Eigenschaften der A+ gekennzeichneten und BS1-D0 und BS2-D0 klassifizierten Barrisol® Spanndecken.



Réalisation : Barrisol®



Réalisation : Barrisol®



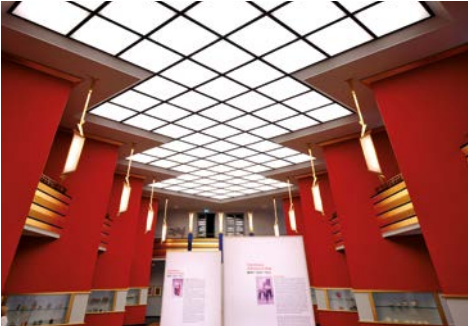

Réalisation : Barrisol®

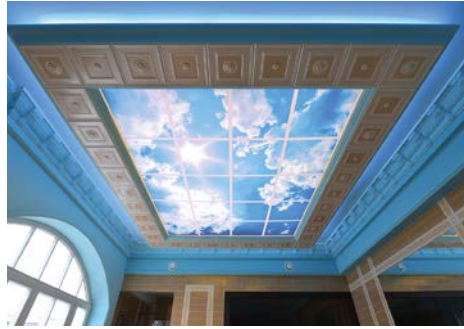

Arch. : Katarzyna Ostaszewska-Kosowski Pracownia

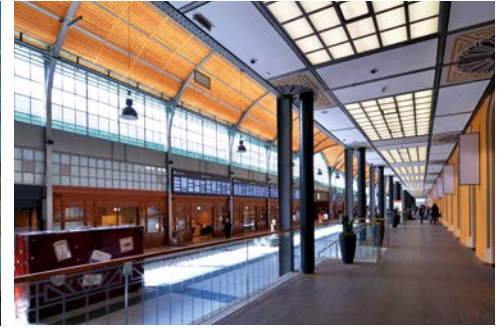

Arch. : Grupa 5 Architekci - Dalles lumineuses



# Barrisol®

## Dalles ■ Tiles ■ Platten

Les dalles en Barrisol® sont des dalles modulaires posées sur des ossatures standards. Classiques, encastrées, lumineuses ou encore imprimées, les dalles Barrisol® offrent une finition unique et la même accessibilité qu'un système de dalles.

Barrisol® tiles are modular tiles installed on standard aluminum frames. Classic, embedded, lighted or printed, Barrisol® tiles offer a unique finish and the same accessibility as a classic ceiling tiles system.

Barrisol® Platten sind lackiert, bedruckt, beleuchtet oder beflockt und werden auf die Struktur eingelegt. Sie bieten die gleiche Zugänglichkeit wie ein übliches Plattensystem.



Arch. : Dejan Todorović



Arch. : MCM architects - Dalles miroir



Arch. : Jaroslaw Łankowski





Arch. : Cüneyt Halvaci



Réalisation : Savi

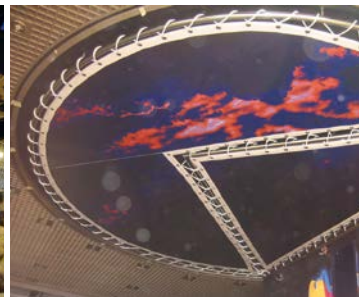

Réalisation : Savi



Réalisation : Savi

# Barrisol® Ttempo®



Ttempo

Fixation par laçage - Fixation by lacing - Befestigungssystem mit Schnüren



Fixation par ressorts - Fixation by spring - Befestigungssystem mit Federn



Barrisol Ttempo® est une solution originale.

Les 230 coloris et 15 finitions des toiles Barrisol® peuvent être tendues grâce à Barrisol Ttempo®, système de fixation unique par laçage ou ressort. Il est idéal dans les grands espaces.

Barrisol Ttempo® is an original solution.

The 230 colours and 15 finishes of Barrisol® membranes can be utilized with the Barrisol Ttempo® system. This fixation system by way of lacings or springs is unique and ideal for large spaces.

Barrisol Ttempo® ist ein einzigartiges System.

Jede Barrisol® Folie (230 Farbtönen und 15 Oberflächen) kann mit dem neuen Barrisol Ttempo® befestigt werden. Stark geeignet für größere Räume, die Folie wird mit Schnüren oder Federn aufgehängt.



Arch. : Laberelle & Koscierskiw



Arch. : Gensler



Lunaperf 30® - réalisation : Filmatec- M.Elbaz



Réalisation : Thomas Dinisi



Design : Dilman





Arch. : Michael Dowd



Arch. : Richard Kramer et Tanneberg/Haas



Arch. : F. Pfeiffer

# Barrisol® Trempoacoustic® $\alpha_w = 1.0$



Piscine  
Maulburg



Gym  
Harjavalta



**Trempoacoustic®**

Classement au feu - Fire classification - Brandverhalten

**B-s2,d0**

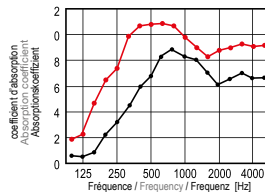

- Barrisol Trempoacoustic® avec isolant / with insulation / mit Isolierung
- Barrisol Trempoacoustic® sans isolant / without insulation / ohne Isolierung

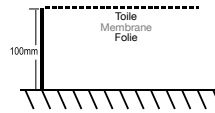

NRC = 0.60  
SAA = 0.63  
 $\alpha_w = 0.60$   
classe - class  
Klasse: C

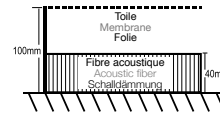

NRC = 0.90  
SAA = 0.93  
 $\alpha_w = 1.00$   
classe - class  
Klasse: A

Barrisol Trempoacoustic® se compose de toiles tissées en fils de verre enduits et tendues par le système de fixation Barrisol Trempo® par laçage, ressorts, ou platines. Les toiles Barrisol Trempoacoustic® améliorent le confort acoustique de tous les espaces, intérieurs ou extérieurs.

Trempoacoustic® existe en 12 finitions, pour découvrir toutes nos finitions, consultez notre échantillon (B711/09).

Barrisol Trempoacoustic® is a line of woven membranes more or less aerated, stretched by utilizing the Barrisol Trempo® lacing, spring or platine system. Indoors or outdoors, Barrisol Trempoacoustic® improves the acoustic environment.

Trempoacoustic® exists in 12 finishes. To discover all our finishes, consult our sample booklet (B711/09).

Barrisol Trempoacoustic® besteht aus Spanndecken, die aus imprägnierten Glasfasern gewebt sind und auf das Befestigungssystem Barrisol Trempo® mit Spannbändern, Federn oder Platinen aufgespannt werden. Die Barrisol Trempoacoustic® Spanndecken verbessern die Raumakustik in allen Räumen, gleich ob innen oder im Freien.

Trempoacoustic® gibt es in 12 Oberflächengüten. Entdecken Sie all unsere Oberflächen anhand unserer Probenbücher (B711/09).



Arch. : Richard Kramer

VIDEO





Arch. : Tapio Antikainen



Arch. : The Uncarved Block

Réalisation : Barrisol®  
 Barrisol® au plafond et Trempo Acoustic® aux murs - Barrisol® on the ceiling and Trempo Acoustic® on the walls  
 Barrisol® an der Decke und Trempo Acoustic® an den Wänden





Réalisation : Lionet

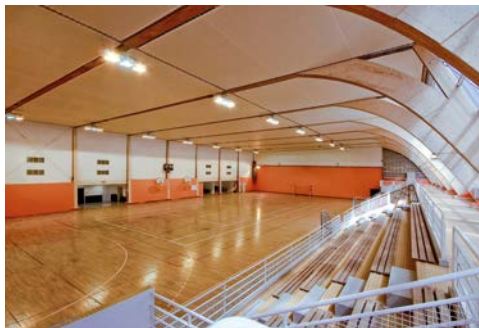

Arch. : Jean-Marc Filliatre



Arch. : Jean-Luc Petithomme

# Barrisol® Trempovision®

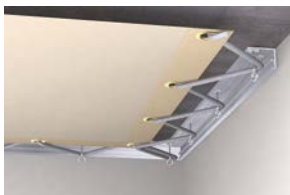

Arch. : S.Piazzon



Réalisation : F. Van Rompu

Barrisol Trempovision® est une gamme de toiles ajourées tendues selon le principe Barrisol Trempo®, par laçage ou ressorts. Les toiles Barrisol Trempovision®, idéales pour des applications en intérieur et en extérieur sont disponibles en 10 coloris et peuvent être imprimées.

Classement au feu : **B S2-d0**

Barrisol Trempovision® is a range of stretched open weave membranes, stretched with the Barrisol Trempo® system, by lacing or springs. Ideal for internal and external space, Barrisol Trempovision® membranes are available in 10 colors and can be printed.

Fire classification : **B S2-d0**

Barrisol Trempovision® ist ein Spanndeckenprogramm, das unter Verwendung des Systems Barrisol Trempo®, mit Band- oder Federverspannung eingesetzt wird. Barrisol Trempovision® Spanndecken, die sich ausgezeichnet sowohl für den Einsatz in Räumen und im Freien eignen, stehen in 10 Farbtönen und als bedruckte Variante zur Verfügung.

Brandklassifizierung : **BS2-d0**

## Trempovision® intérieur - internal application - im Innenbereich



Arch. : Kerem Erginoğlu - Hasan Çalışlar



Arch. : Jean-Claude Petitoolin

## Trempovision® extérieur - external application - im Außenbereich



Barrisol® Trempovision®



Barrisol® Trempovision®





Réalisation : Barrisol®



Réalisation : STX Europe



Réalisation : Barrisol®

## Barrisol® IMO



Le Grand Cru



Carnival Destiny



IMO

Grâce à sa composition spécifique, la toile Barrisol® s'adapte parfaitement dans les lieux humides. Utilisées en neuf ou en rénovation, les toiles Barrisol® sont certifiées 100% utilisables pour les constructions navales, qu'il s'agisse de yacht ou d'autres types de bateaux tels que des bateaux de plaisances ou de croisière. Elles répondent aux exigences du test de la perméabilité à la vapeur d'eau et peuvent ainsi être installées dans tous les lieux humides (bateaux, piscines, spas, etc.).

Avantages de la gamme Barrisol® IMO :

- Pas de vibration
- Résiste à l'humidité
- Faible poids : 220 g en moyenne (hors structure)

Thanks to its specific composition, the Barrisol® fabric adapts perfectly in humid places. Used in new or renovated, Barrisol® membranes are certified 100% usable for shipbuilding, whether it is yacht or other types of boats such as pleasure boats or cruise. They meet the requirements of the test permeability to water vapor and can thus be installed in all wet places (boats, pools, spas, etc.).

Advantages of the Barrisol® IMO range:

- No vibration
- Moisture resistant
- Low weight: 220g on average (excluding structure)

Dank seiner spezifischen Zusammensetzung eignet sich das Gewebe von Barrisol® hervorragend für feuchte Räume. Die Gewebe von Barrisol® sind als 100 % schiffstauglich zertifiziert, sowohl für Neueinrichtungen als auch für Renovierungen, ob es sich um Yachten oder andere Arten von Freizeitbooten oder

Kreuzfahrtschiffen handelt. Sie wurden erfolgreich auf Wasserdampfdurchlässigkeit getestet und können deshalb in allen feuchten Räumen verlegt werden (Schiffe, Schwimmbäder, Spa-Einrichtungen usw.)

Vorteile der Barrisol® IMO-Reihe:

- Keine Vibration
- Feuchtigkeitsresistent
- Geringes Gewicht: 220g im Durchschnitt (ohne Struktur)



Arch. : Atkin Global - Photo du bateau vue de l'extérieur - Photo of boat viewed from the outside - Foto des Boots von außen betrachtet : Baldwin040° Oasis of the Sea



Réalisation : Barrisol®  
Viking Grace



Arch. : IDO  
Ferry Pendik



Réalisation : Barrisol®  
Viking Grace



Réalisation : Barrisol®  
Traversier Alphonse des Jardins



Réalisation : Escapades Memphremagog  
Bâteau «Le Grand Cru»



Réalisation : Barrisol® - Welch  
Carnival Destiny





Arch. : Nagy János - Bred Ltd



Arch. : AIA architectes



Arch. : AIA architectes

# Barrisol®

## Santé ■ Health ■ Gesundheit

De l'accueil à l'espace de soins, une surface totalement personnalisable

Barrisol® est un système breveté qui offre une finition parfaite pour la rénovation et la décoration de vos espaces de santé. Les toiles sur-mesures Barrisol® sont tendues de mur à mur, sur profils Barrisol®.

**Barrisol® vous propose des solutions exclusives de rénovation et de décoration des murs et plafonds :**

- installés en moins d'une journée
- sans production de déchet ou de saleté
- disponibles dans une palette de plus de 230 coloris et finitions

Un espace à votre image

Motifs, photos, créations artistiques, sont imprimables sur les 230 coloris et finitions disponibles dans la palette Barrisol®. Associées à des solutions d'éclairage spécifiques (LEDs, fibres optiques...), les impressions sont sublimées et élégantes.

The welcome and healthcare areas are completely customizable

Barrisol® is a patented system which delivers a perfect finish for renovating and decorating your health service. Tailor-made Barrisol® sheets are stretched from wall to wall on Barrisol® profiles.

**Barrisol® offers you exclusive solutions for renovating and decorating walls and ceilings:**

- installation in less than a day
- no waste or dirt
- a range of more than 230 colours and finishes to choose from

A space that reflects your image

Patterns, photos and artistic creations can be printed on the 230 colours and finishes available in the Barrisol® palette. Combined with specific lighting solutions (LEDs, optical fibres, etc.), the printings are heightened and elegant.

Bereits am Empfang des Wellness-Bereichs fühlt sich der Kunde umsorgt und willkommen

Mit dem patentierten System bietet Barrisol® die perfekte Ausstattung für die Renovierung und Einrichtung Ihrer Wellness-Oasen. Maßgeschneiderte Decken von Barrisol® spannen sich auf Barrisol®-Profilen von Wand zu Wand.

**Barrisol® bietet Ihnen exklusive Lösungen für die Renovierung und Dekoration von Wänden und Decken:**

- eingebaut an weniger als einem Tag
- ohne Schmutz und Abfälle
- verfügbar in einer Palette von mehr als 230 Farbtönen und Strukturen

Räumlichkeiten mit Ihrem Gesicht

Motive, Fotos, künstlerische Kreationen können in den 230 Farbtönen und Oberflächengüten der Palette von Barrisol® gedruckt werden. In Kombination mit speziellen Beleuchtungslösungen (LEDs, Lichtwellenleiter, usw.), schaffen sie den Eindruck von Erhabenheit und Eleganz.



### Qualité, sécurité & écologie

Les toiles Barrisol® sont 100% conformes à la norme CE, fabriquées avec des plastifiants sans phtalate, garanties sans cadmium, sans mercure et sans arsenic. Les toiles Barrisol® sont classées au feu selon les normes européennes et internationales (BS1-D0, BS2-D0, BS3-D0).

Tous les tests au feu, tests de fumée et de toxicité confirment que les produits Barrisol® sont adaptés pour l'aménagement des lieux ouverts aux publics et notamment les espaces médicalisés.

Les plafonds tendus Barrisol® sont étiquetés A+ (note la plus élevée) conformément à la législation en vigueur sur la qualité de l'air intérieur.

### Quality, security & ecology

Barrisol® sheets are 100% compliant with CE legislation and manufactured with plasticizers free of phtalate, cadmium, mercury and arsenic. Barrisol® sheets are fire rated according to the European and international effective norms (M1, BS1-D0, BS2-D0, BS3-D0).

All fire, smoke and toxicity tests carried out confirm that Barrisol® products are adapted for public places, including healthcare facilities.

Barrisol® stretch ceilings are labeled A+ (the most efficient energy class) in compliance with the legislation in force as regards indoor air quality.

### Qualität, Sicherheit und Ökologie

Spanndecken von Barrisol® entsprechen zu 100% der CE-Norm und werden mit Weichmachern produziert, die garantiert frei von Phtalaten, Cadmium, Quecksilber und Arsen sind.

Die Barrisol® Spanndecken sind gemäß den europäischen und internationalen Normen brandklassifiziert (BS1-D0, BS2-D0, BS3-D0).

Alle Brand-, Rauch- und Giftprüfungen bestätigen, dass die Produkte von Barrisol® für die Ausstattung öffentlicher und insbesondere medizinischer Einrichtungen geeignet sind.

Spanndecken von Barrisol® sind gemäß den geltenden Bestimmungen zur Raumluftqualität mit A+ (höchste Note) gekennzeichnet.



Arch. : AIA architectes

### Solutions Barrisol Lumière® & Lumière Color®

La lumière et la couleur au service du bien-être de vos patients.

Pour que vos patients se sentent encore plus à l'aise, les solutions Barrisol Lumière® et Barrisol Lumière Color®, vous permettent d'offrir un espace de détente grâce à une utilisation optimale de la lumière et de la couleur.

### Lösungen mit Barrisol Lumière® & Lumière Color®

Licht und Farbe zum Wohl Ihrer Patienten.

Damit sich Ihre Patienten noch wohler fühlen, bieten Ihnen Varianten unter Verwendung von Barrisol Lumière® und Barrisol Lumière Color®, viele Möglichkeiten, durch die optimale Nutzung von Licht und Farbe Räume der Entspannung zu schaffen.

### Barrisol Light® & Lumière Color® Solutions

Light and color for the wellbeing of your patients of relaxation thanks to the optimal use of light and colour.

## Exemples de personnalisation - Customization examples - Beispiele für kundenspezifische Ausstattung



Un cadre Barrisol Lumière® intégré à un plafond laqué - A Barrisol Light® frame integrated to a lacquered ceiling - Ein Rahmen Barrisol Lumière® eingepasst in eine lackierte Decke



Un plafond Barrisol Print your Mind® ciel - A printed Barrisol® ceiling - Eine Barrisol®-Decke mit gedrucktem Himmel



Un plafond Barrisol Print your Mind® rétro-éclairé ciel avec arbres - A backlit printed Barrisol® ceiling with trees - Eine Barrisol®-Decke mit hintergrundbeleuchtetem Himmel mit Bäumen



# Barrisol®

## Projets d'Exception Exceptional projects Einzigartige Projekte

Suite des projets d'exceptions ■ Continuation of special projects ■ Fortsetzung der einzigartigen Projekte

HEYDAR ALIYEV CENTER - Azerbaijan

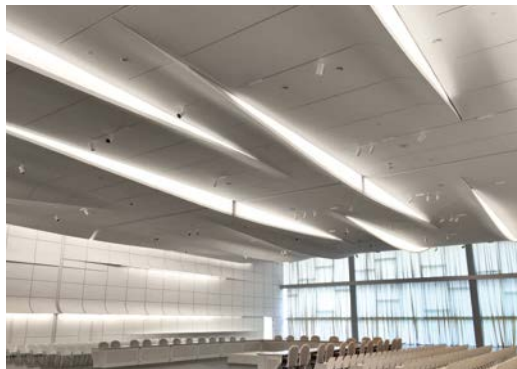

Arch. : Zaha Hadid

## TAMPA MUSEUM OF ARTS - USA

2 500 m<sup>2</sup> de Barrisol Acoustics® - 26909.78 sq ft of Barrisol Acoustics® - 2 500 m<sup>2</sup> von Barrisol Acoustics®



Arch. : Stanley Saitowitz Office/ Natoma Architects, Inc.



V.CITY - Hong Kong



Designer : Benoy



VOLVO BAKU - Azerbaïdjan

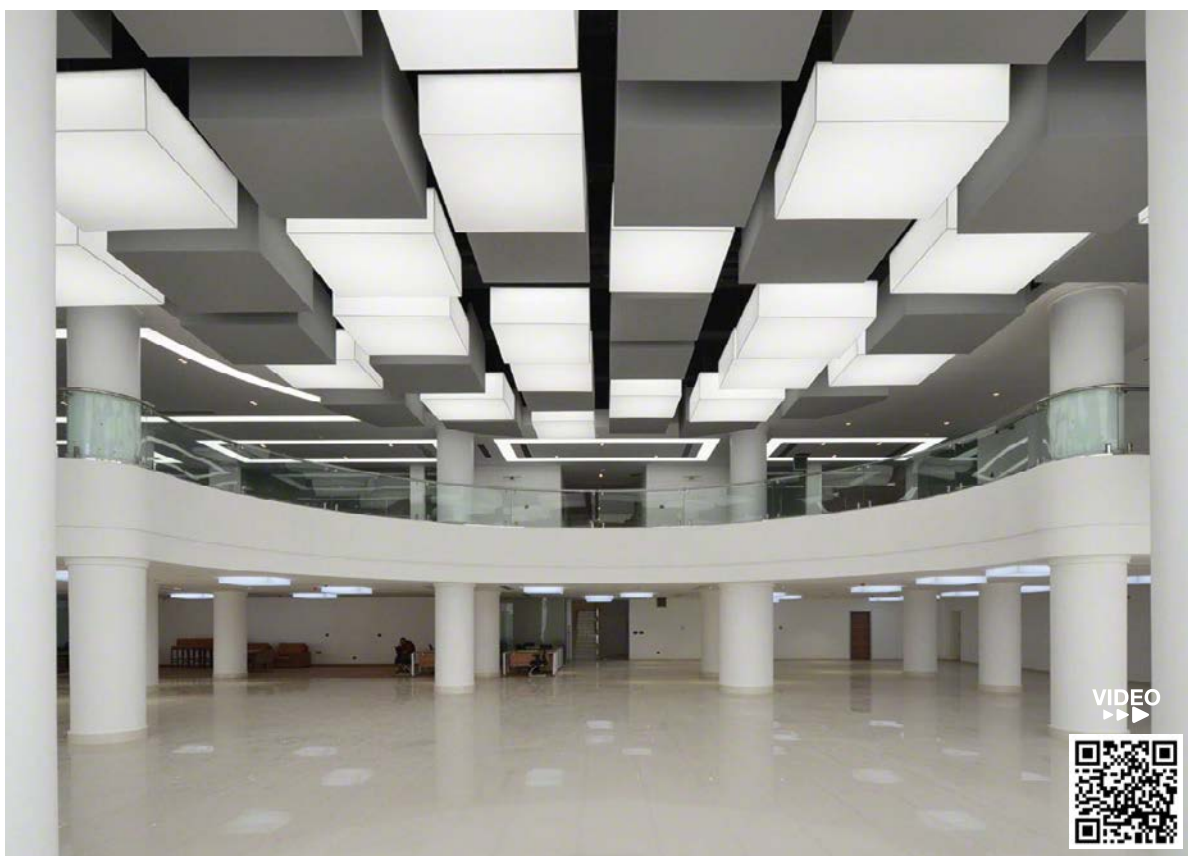

Designer : BS GROUP Taleh Aliyev



SHOWROOM CITROËN - Champs Élysées - France



Arch. : agence Manuelle Gautran Architecture

COLISÉE DE ROME - Italie

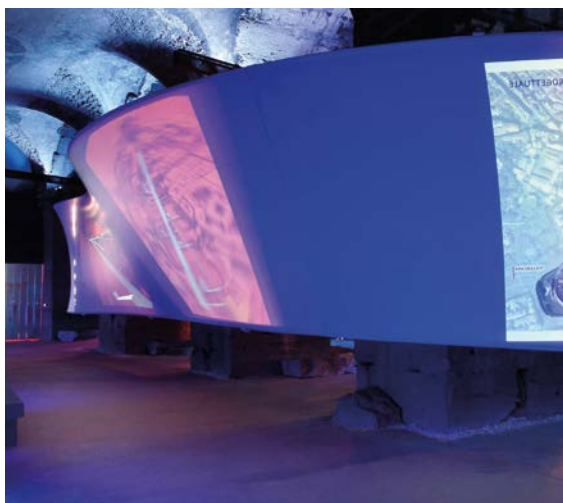
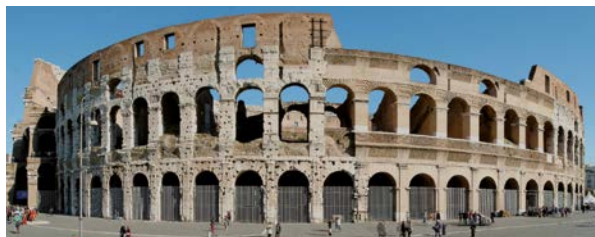

Arch. : Doriana et Massimiliano Fuksas



PROJET FUKSAS - Kensington Garden - Italie



Arch. : Doriana et Massimiliano Fuksas

SIÈGE DE L'OPAC - France



Design : agence Brullmann et Crochon+Associés



ESPACE VIP VODAFONE - République Tchèque



Design : Federico Diaz

FEDERATION SQUARE - Australie

3 000 m<sup>2</sup> de Barrisol® Lumière Acoustique® 3D - 32291.73 sq ft of Barrisol® Acoustics and light 3D - 3 000 m<sup>2</sup> von Barrisol Akustisches Licht® und 3D



Arch. : cabinets d'architecture Lab Architecture et Bates Smart



MEDIACITÉ - Belgique



Arch. : Ron Arad

SANDCRAWLER LUCAS - Singapour

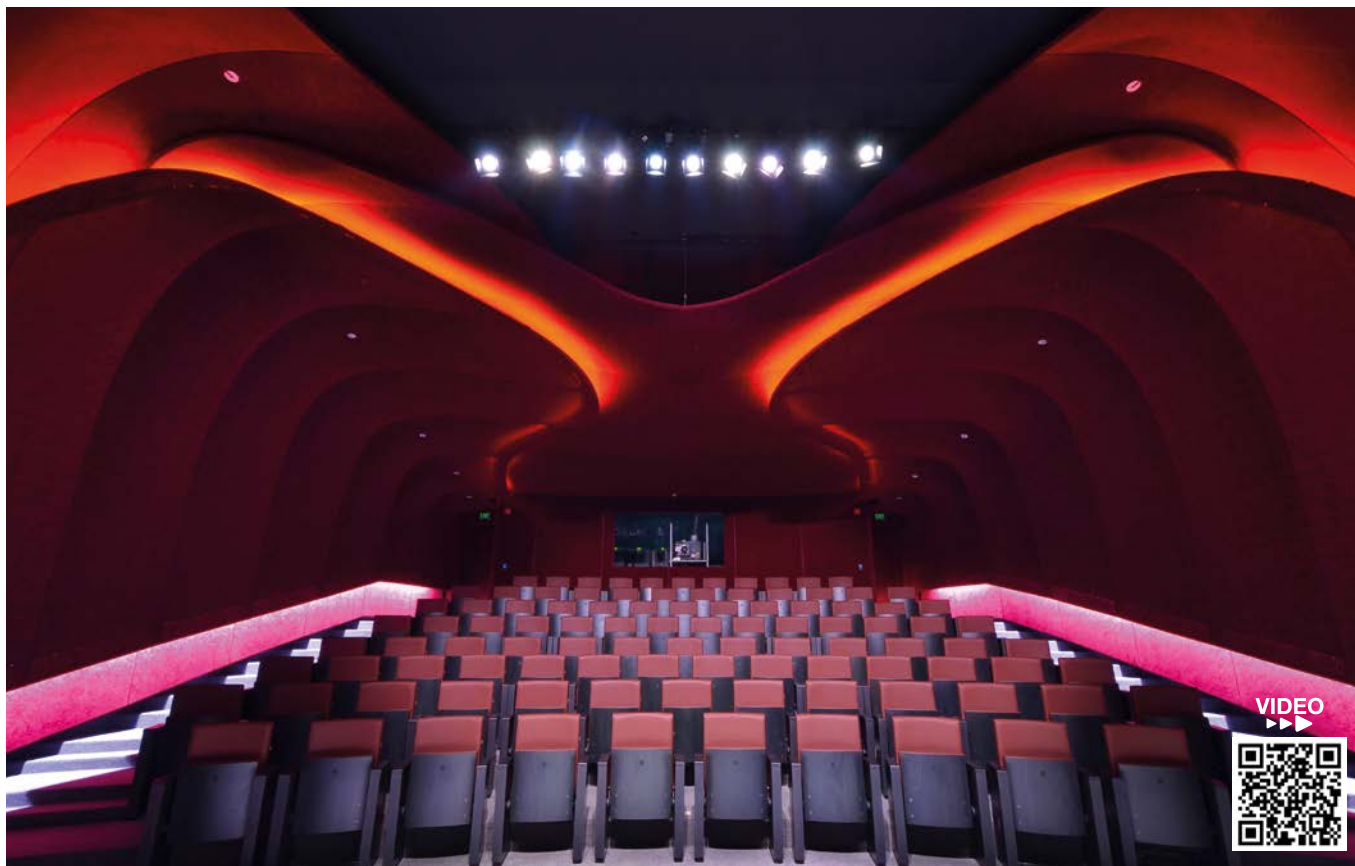

Arch. : Aedas Architects



ERASMUS - Pays-Bas

3 300 m<sup>2</sup> de Barrisol Lumière Acoustique® - 35520.9 sq ft of Barrisol Acoustic Light® - 3 300 m<sup>2</sup> von Barrisol Akustisches Licht®

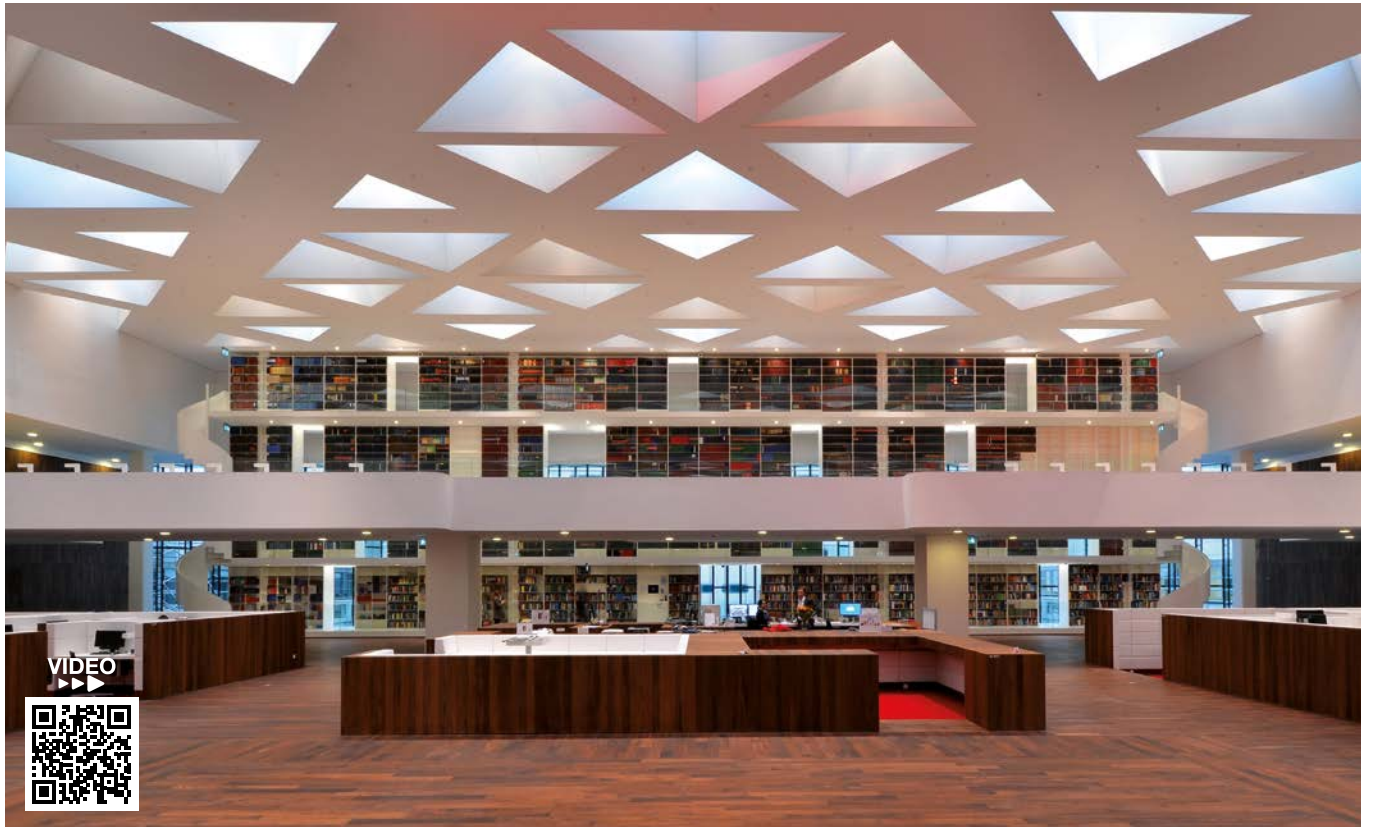

Arch. : Claus en Kaan

VOLKSWAGEN HEADQUARTERS - Allemagne



Design : Plexgroup



WOLLONGONG UNIVERSITY - Australie



Arch. : ARINA Consultants

PAVILHAO DO CONHECIMENTO - Portugal

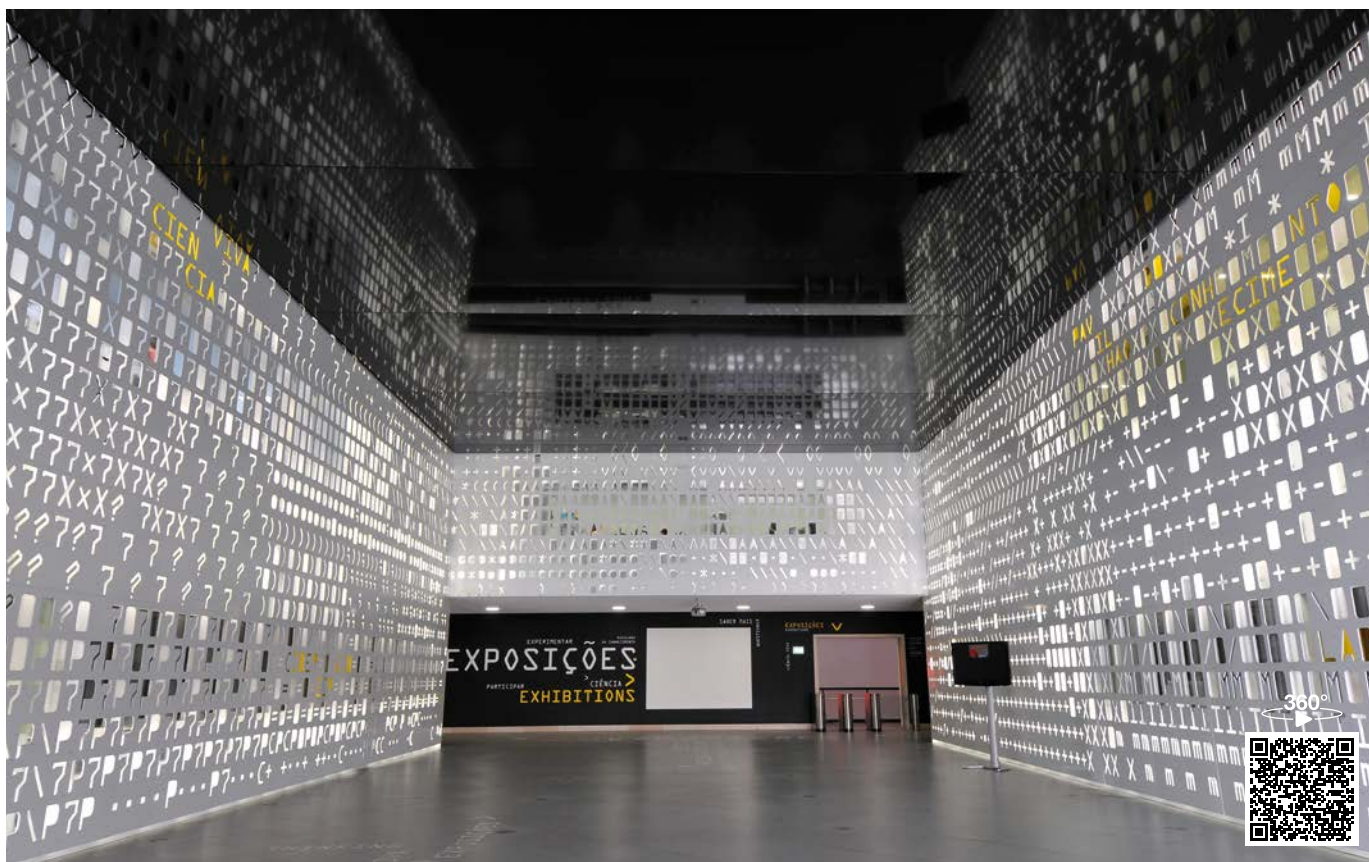
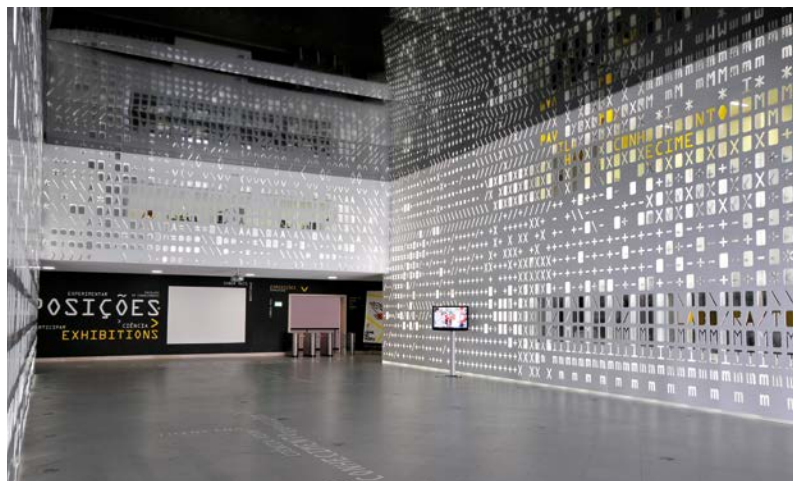

Ach. : João Luis Carrilho



STEDELIJK MUSEUM - Pays-Bas



Arch. : Benthem Crouwel Architects

PREM HOUSE - Singapour

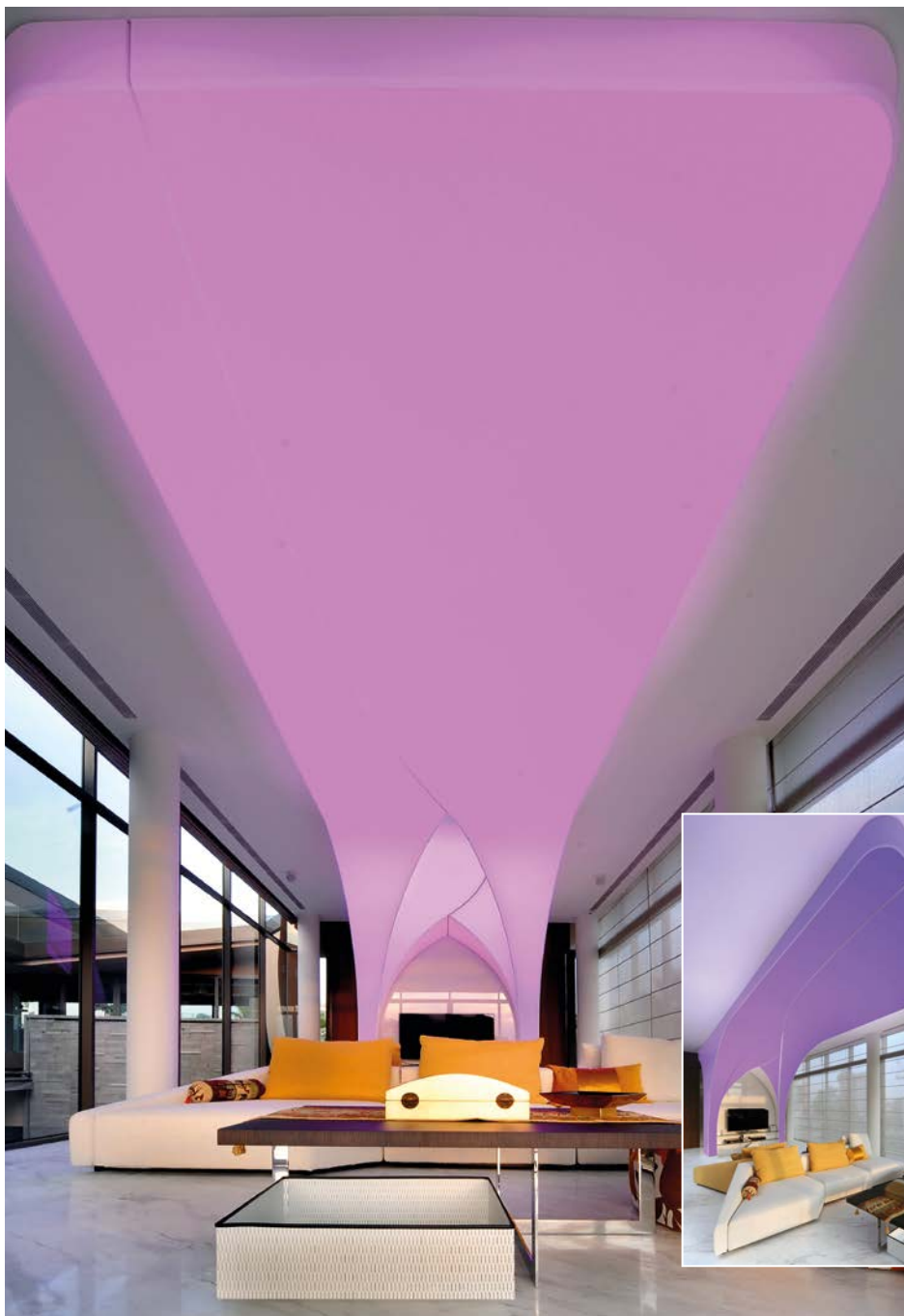

Arch. : ETHospace PTE LTD



NETWORK RAIL HEADQUARTERS - Royaume-Uni

5 296 m<sup>2</sup> de Barrisol Acoustics® - 57005,67 sq ft of Barrisol Acoustic® - 5 296 m<sup>2</sup> von Barrisol Acoustics®



Arch. : GMW Architects

CENTRE AQUATIQUE DU VAL D'EUROPE - France

2 304 m<sup>2</sup> de Barrisol Acoustics® A30 - 24800,05 sq ft of Barrisol Acoustic® A30 - 2 304 m<sup>2</sup> von Barrisol Acoustics® A30

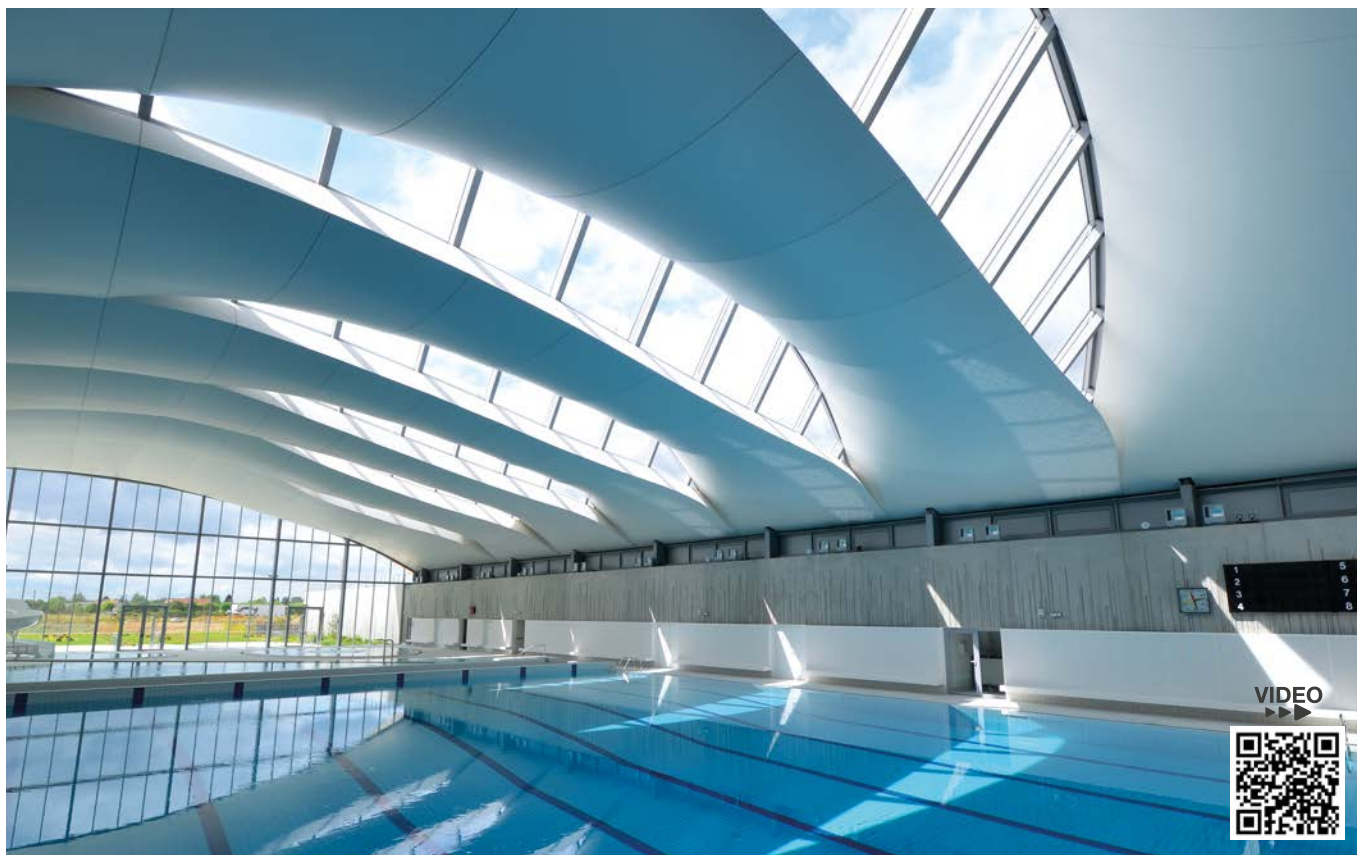

VIDEO  
▶▶▶



Arch. : Marc Mimram



OPEN SPACE OFFICE - Amérique du Sud

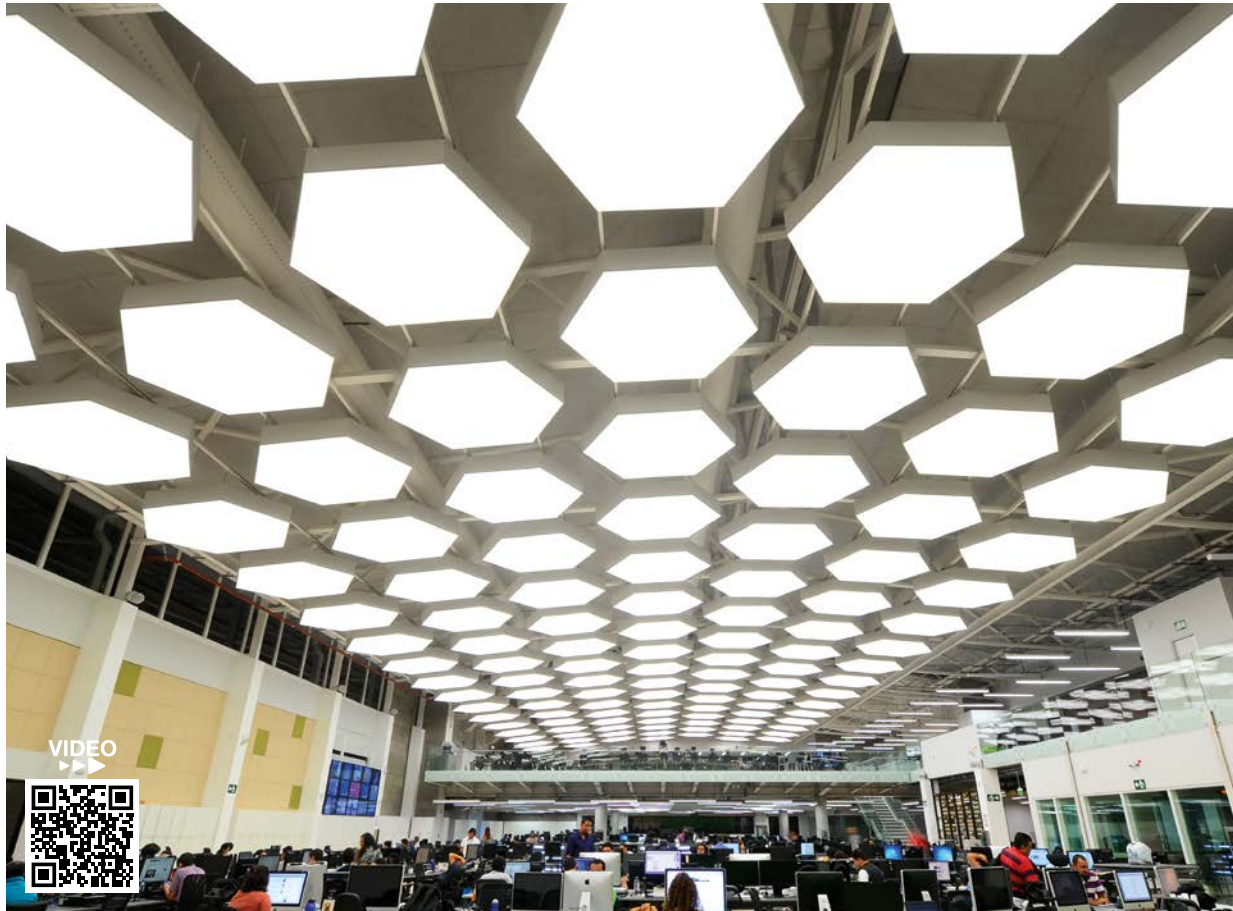

Arch. : Parq Arquitectos

PLACE QUÉBEC - Canada

4 500 m<sup>2</sup> de Barrisol® Reflet laqué et bandes lumineuses  
48437.6 sq ft of Barrisol® Lacquered Reflection and light strips - 4 500 m<sup>2</sup> von Barrisol® Die lackierte Lichtreflexion und Lichtstreifen

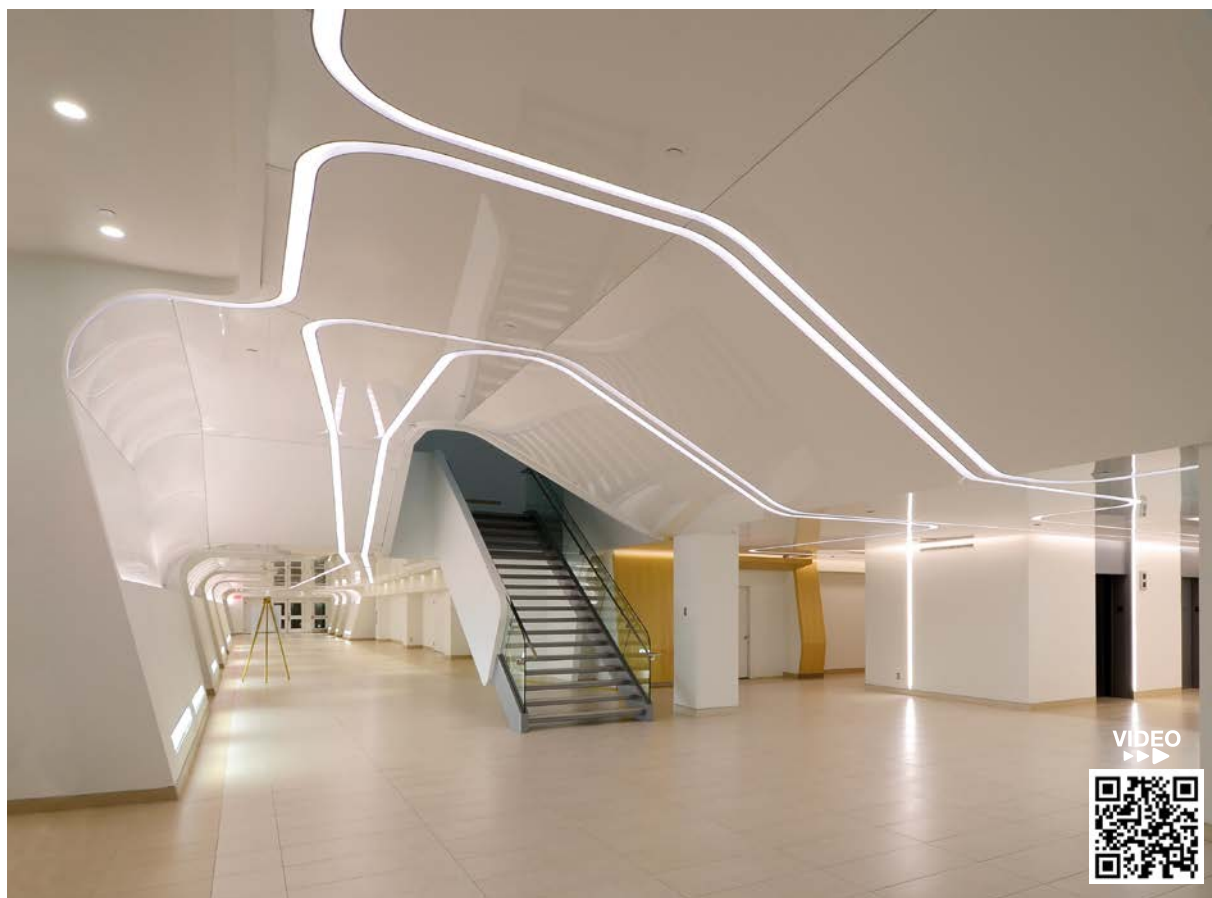

VIDEO  
▶▶



Arch. : Atelier 21



BRISBANE CITY HALL - Australie

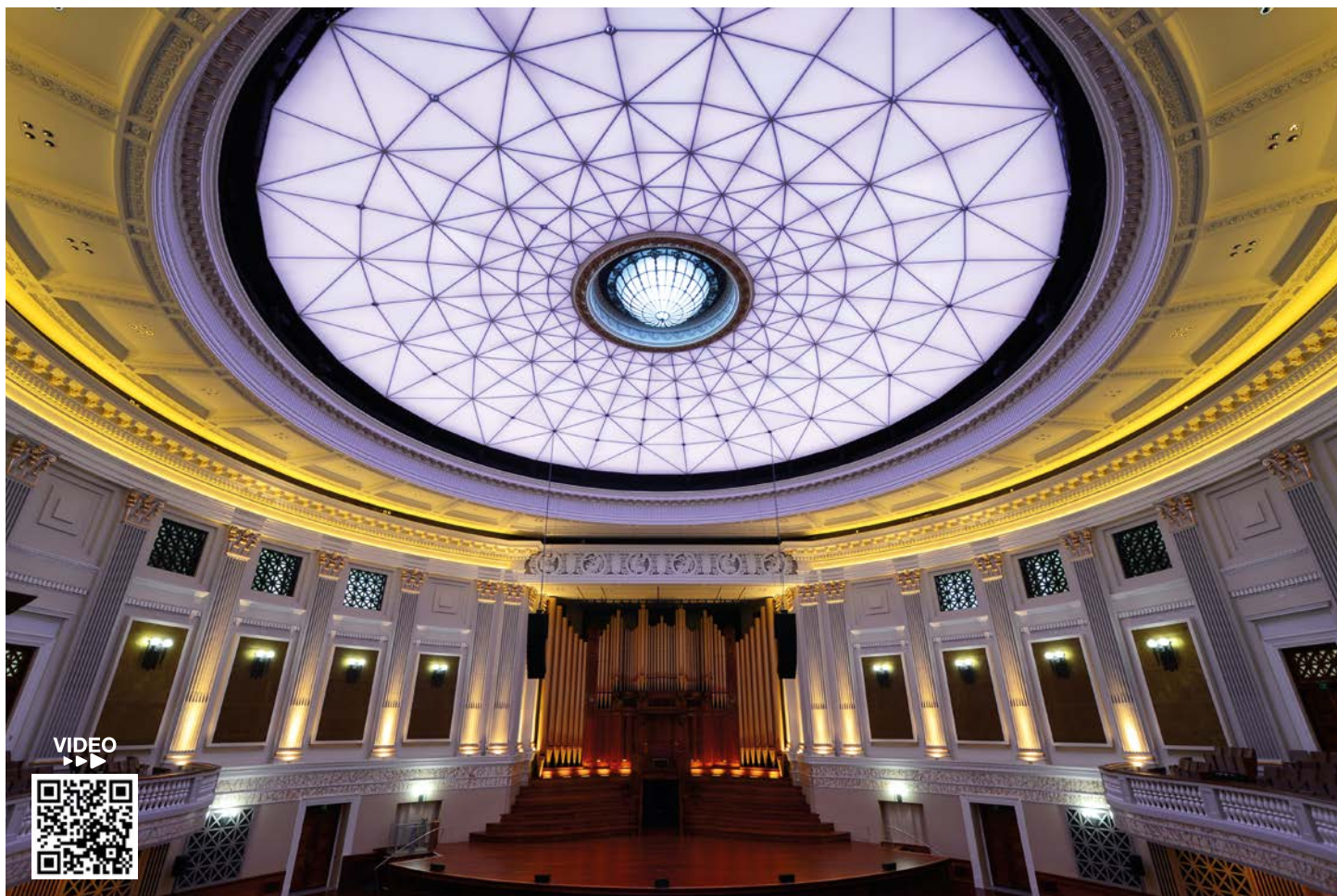
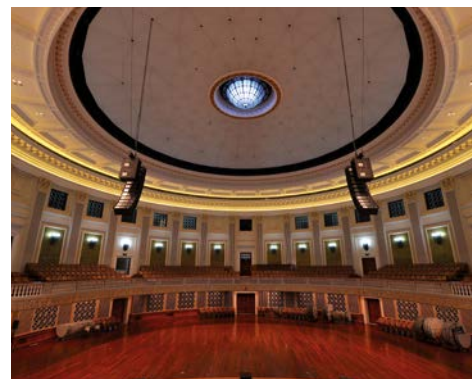
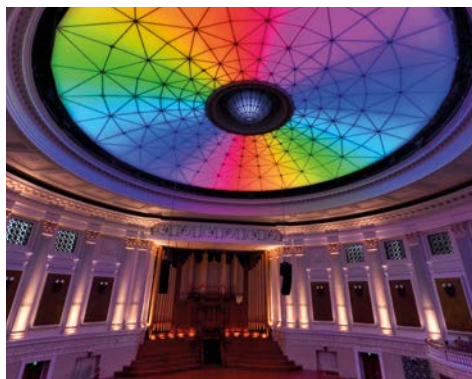

VIDEO



Arch. : Tanner Kibble Denton & GHD (TannerGHD)



NOVO NORDISK - Danemark

2 500 m<sup>2</sup> de Barrisol® Acoustique® - 26909.78 sq ft of Barrisol® Acoustic® - 2 500 m<sup>2</sup> von Barrisol Acoustics®

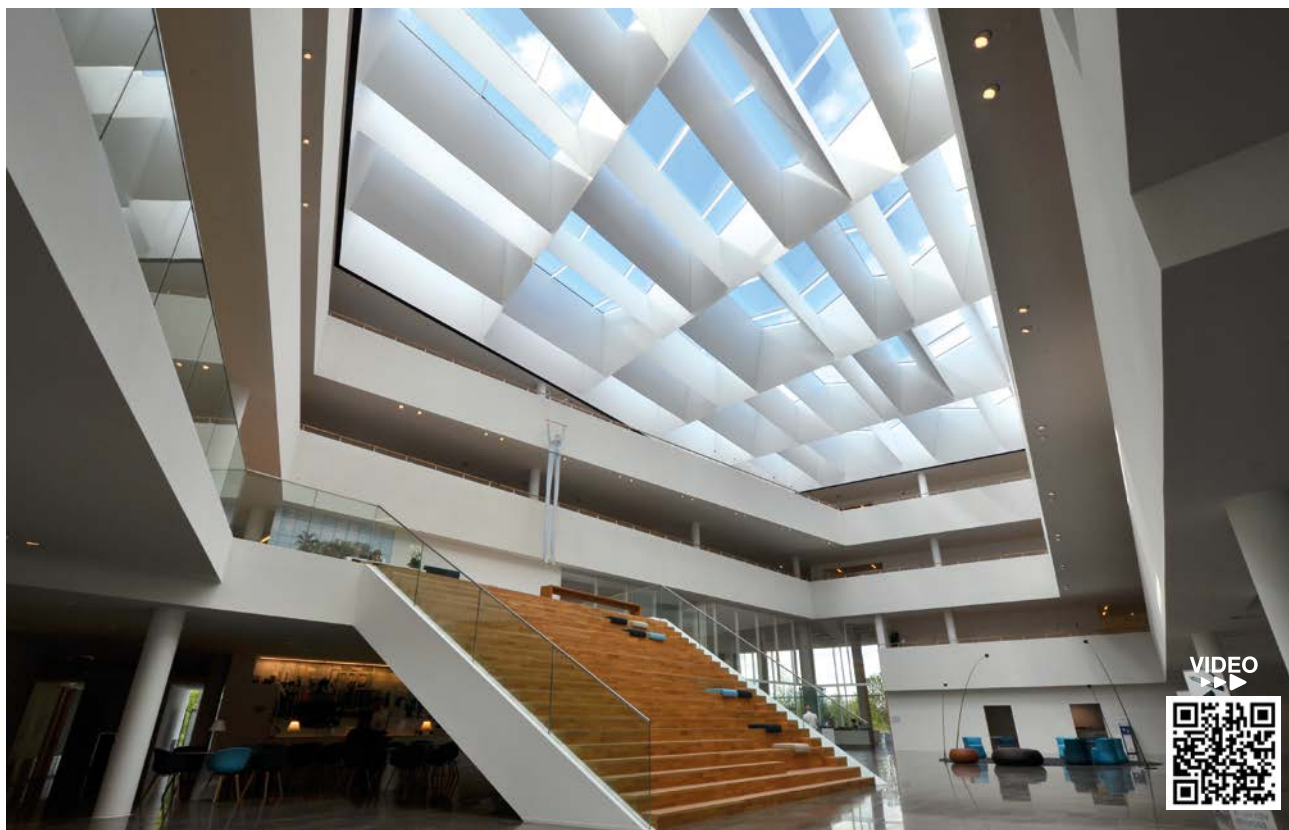

Arch. : Henning Larsen



FONDERIE DE MULHOUSE - France

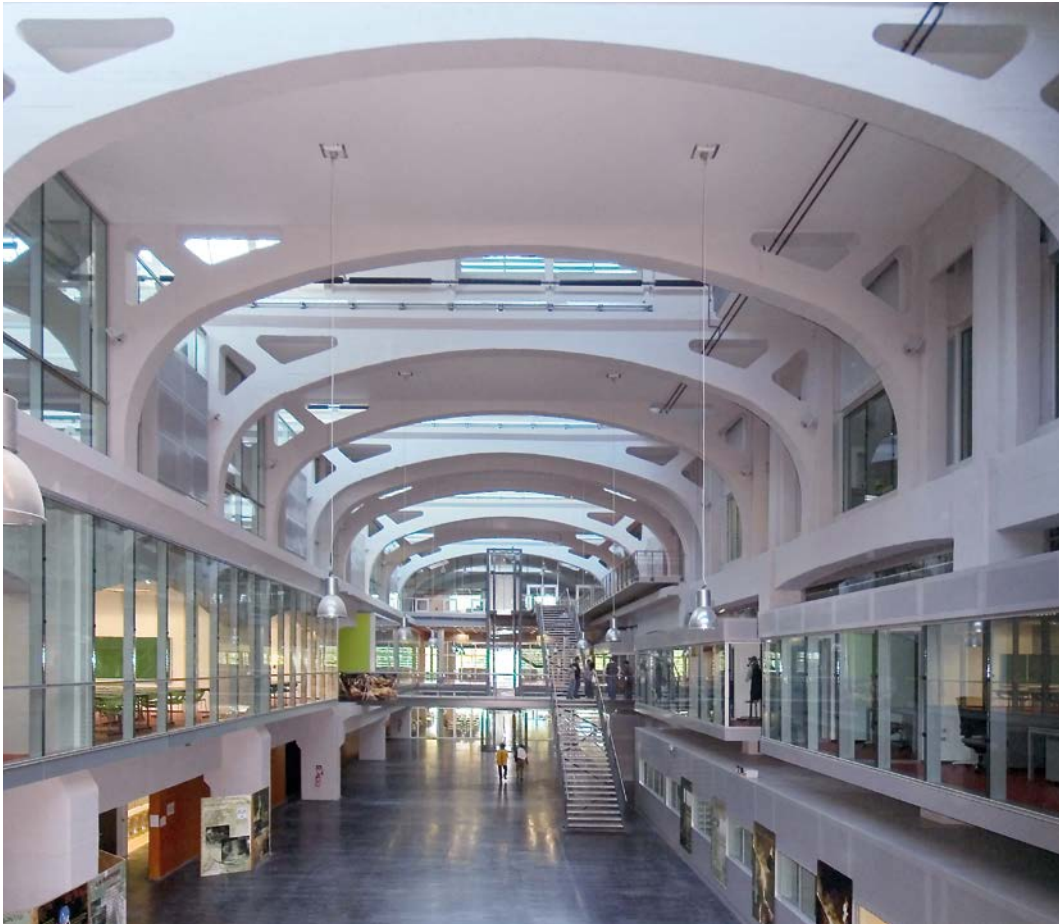

Arch. : Christian PLISSON

STAND ROSS LOVEGROVE - Belgique

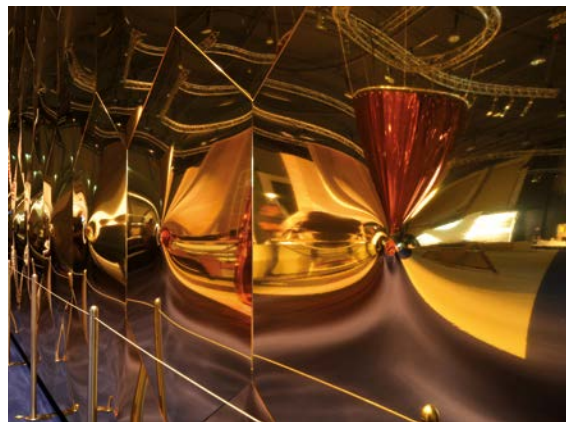

Designer : Ross Lovegrove for Barrisol® Normalu® S.A.S



JOHN HANCOCK CENTER OBSERVATORY - USA

400 m<sup>2</sup> de Barrisol Mirror® - 4305,56 sq ft of Barrisol Mirror® - 400 m<sup>2</sup> von Barrisol Mirror®



Arch. : Gensler

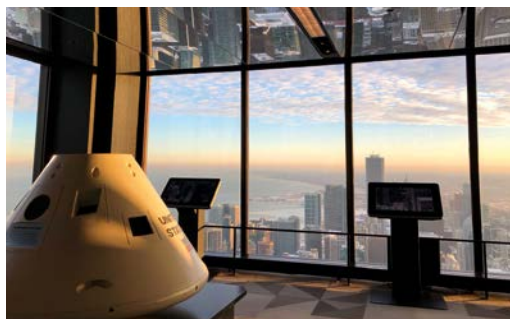



MICROSOFT FLAGSHIP STORE - New York



Arch. : Gensler



MICROSOFT STORE - Australie





HALL D'ENTRÉE - Finlande



Arch. : Jari Kinnunen - Gullstén & Inkinen Design & Architecture





WEDDING SALON RUZA MOSTAR - Bosnie

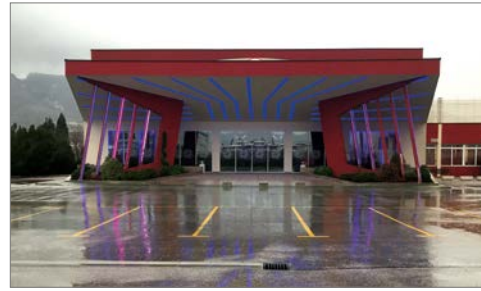

VIDEO



Arch. : Edo Kadribegovic - Designer : studio "Arten" doo







ASSAS BIBLIOTHÈQUE - France



Arch. : Christian Laquerriere



Arch. : Dara KIRMIZITOPRAK Architecture



INSTITUT VISION ET SON - Pays-Bas



Arch. : Neutelings Riedijk





HELEZON PLAZA - Turquie



Arch. : YAPIGEN Architecture-Mehmet Esat Özkeçeci

### CENTRE CULTUREL - Koweït

5 000 m<sup>2</sup> de Barrisol®

53819,55 sq ft of Barrisol® - 5 000 m<sup>2</sup> von Barrisol®

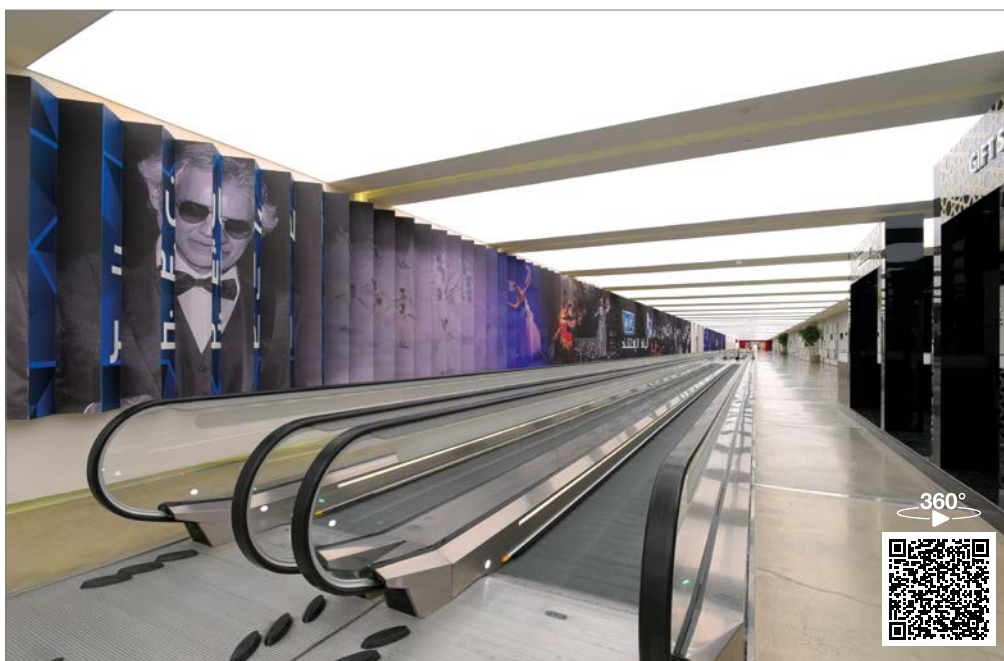

Arch. : SSH International, Architects



BRANDHORST MUSEUM - Allemagne



Arch. : Sauerbruch Hutton





LOUVRE ABU DHABI - Abu Dhabi



Arch. : Jean Nouvel

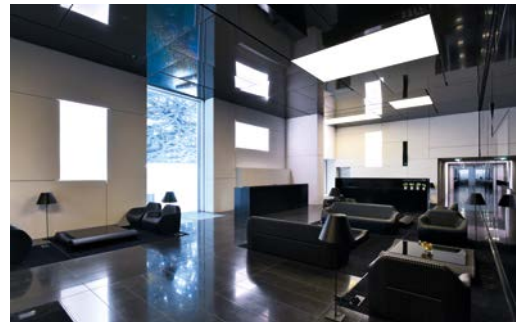
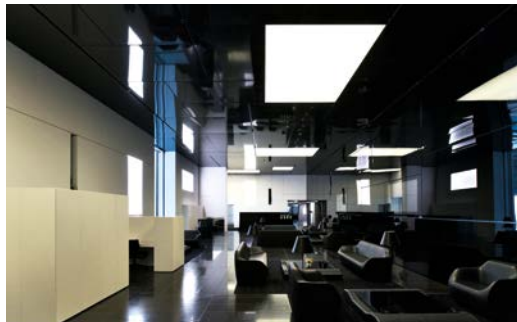



SUN PLAZA - Roumanie

10 000 m<sup>2</sup> de Barrisol Acoustics® - 107639.1 sq ft of Barrisol Acoustics® - 10 000 m<sup>2</sup> von Barrisol Acoustics®



Arch. : Chapman Taylor

CENTRE NATIONAL DE CONVENTION DU COSTA RICA - Costa Rica  
2 250 m<sup>2</sup> de Barrisol Acoustics® A15 - 24218,8 sq ft of Barrisol Acoustics® - A15 2 250 m<sup>2</sup> von Barrisol Acoustics® A15

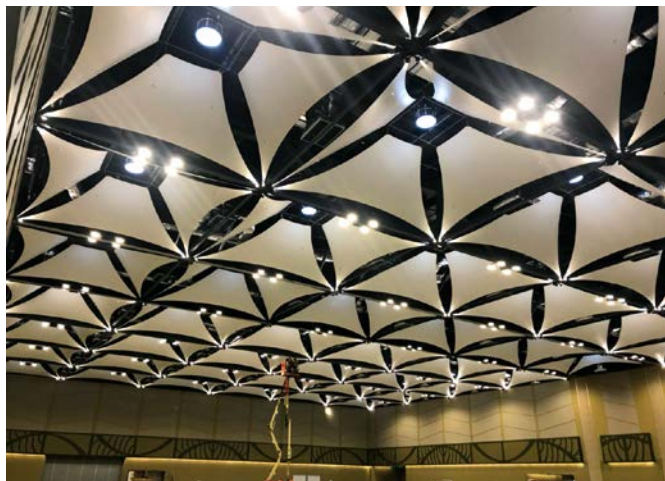

Arch. : Gensler



EXPOSITION ROSS LOVEGROVE AU CENTRE POMPIDOU- France



Designer : Ross Lovegrove





BANQUE POPULAIRE DE METZ - France



Arch. : Parallel Architecture

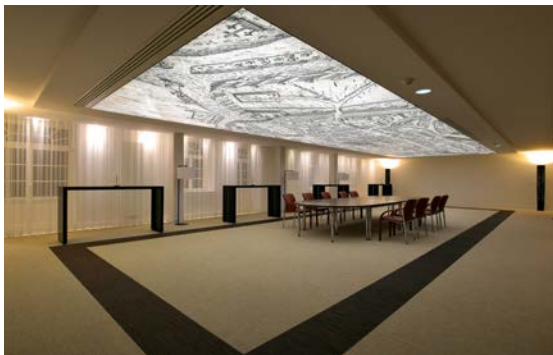



TEMPTATION RESSORT - Mexique



Designer : Karim Rashid

VERANDA RESTAURANT - Koweït



Arch. : Alia Alghunaim - Design Manager : Mabanee Company S.A.K



LASVIT MILAN DESIGN WEEK - Italie

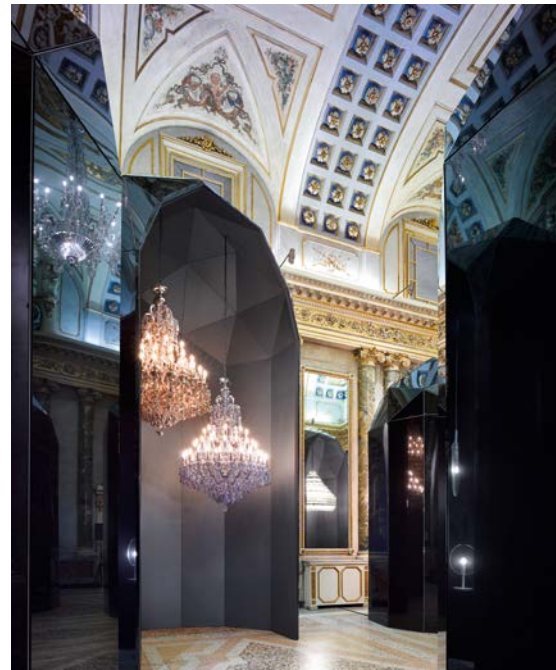

Réalisation : Barrisol®



POSNANIA - Pologne

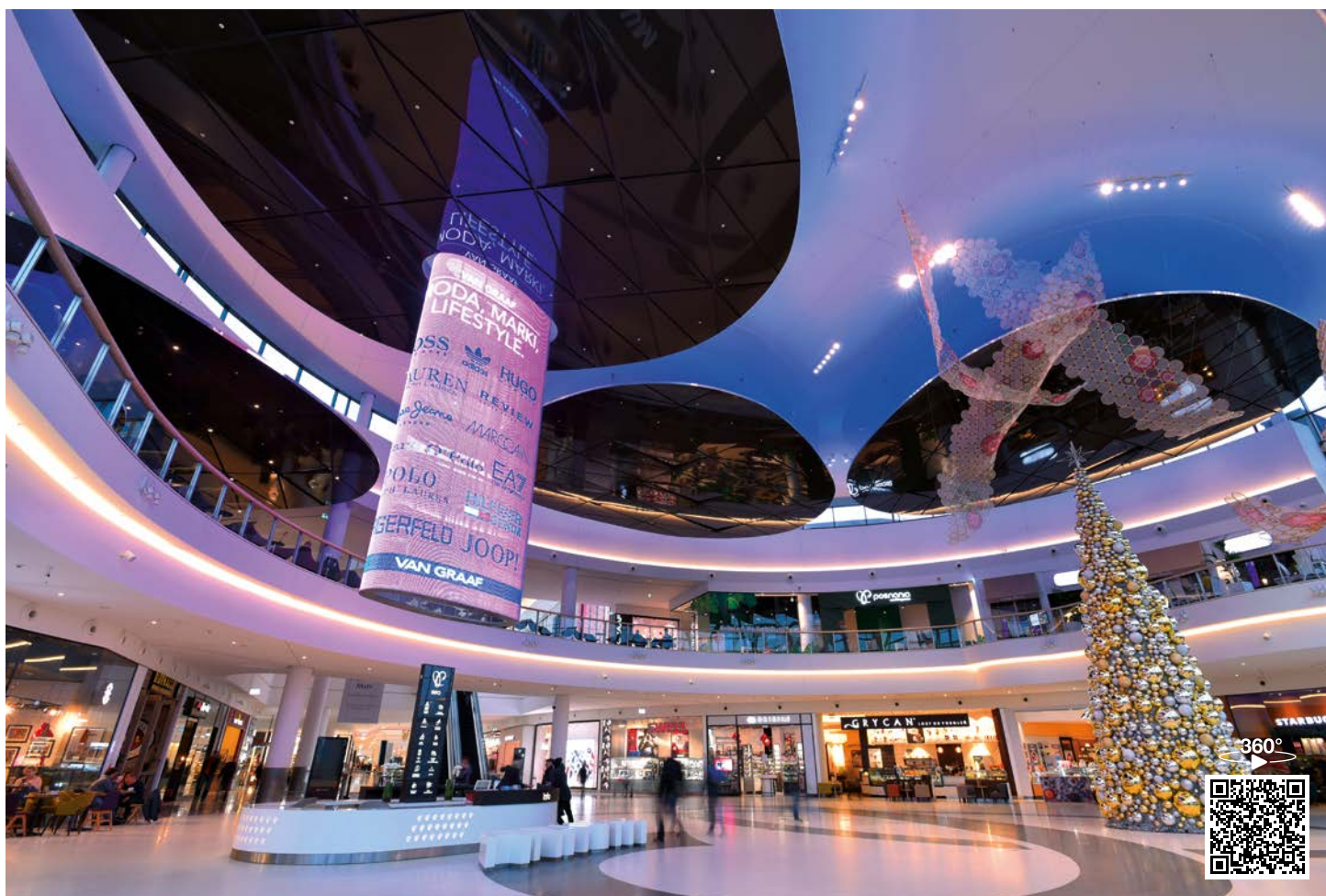
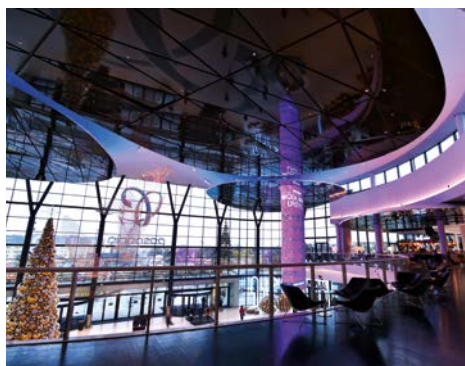



PISCINE ARLAMOW - Pologne



Arch. : Wacław Matłok & Magdalena Dendewicz-Matłok

HOTEL W J BY JOSE ANDRES - Mexique

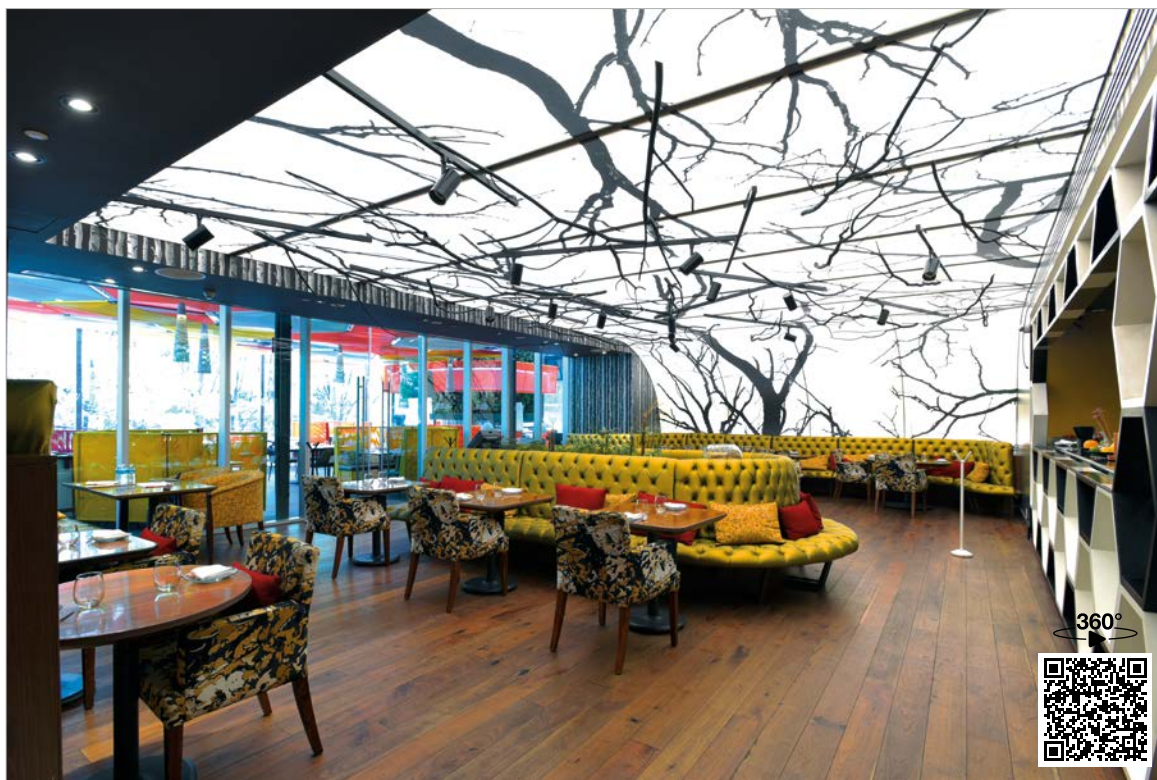
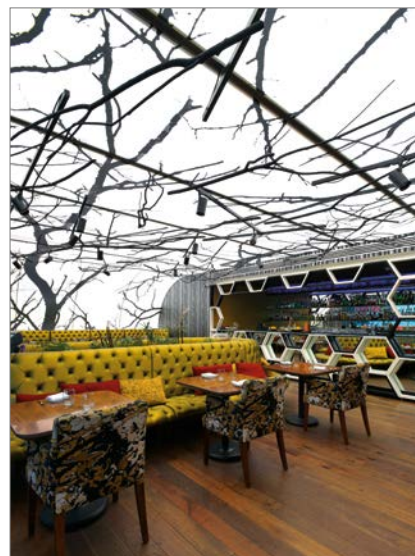

Arch. : Capella García Arquitectura



KOMA - République Tchèque

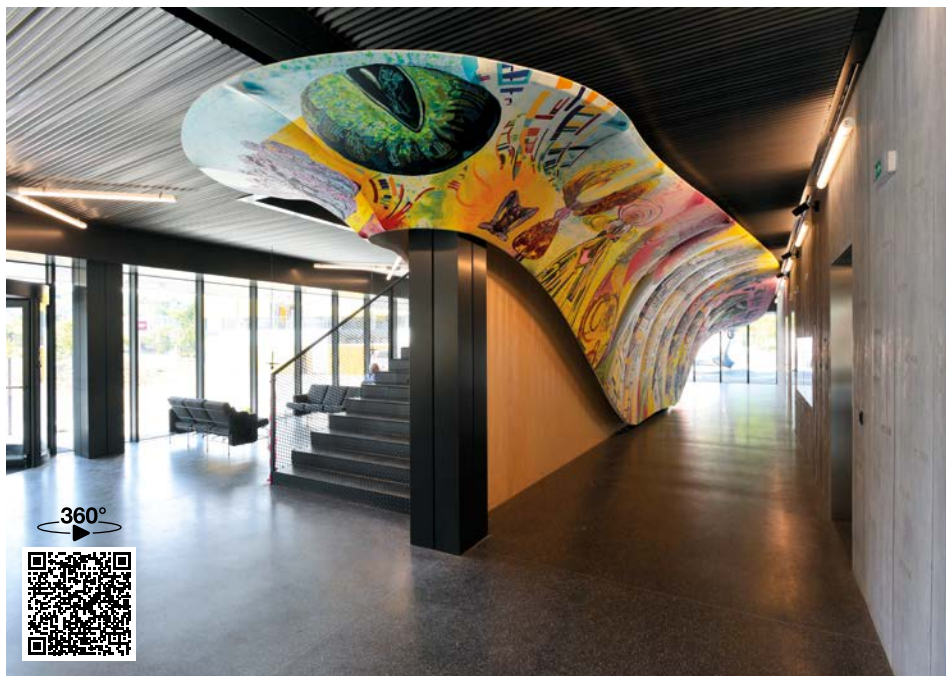
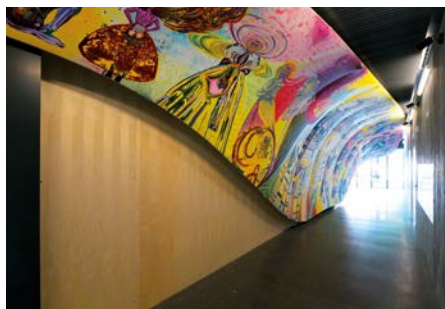

Artiste : Barbora Šlapetová - Sculpteur : Lukáš Rittstein



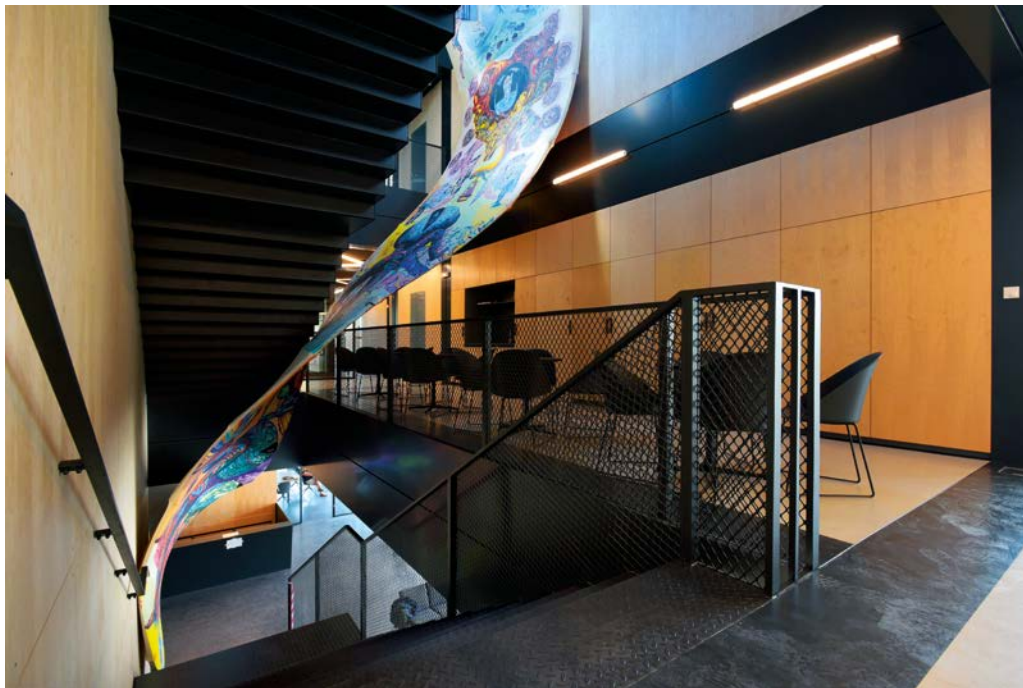



## THE AVENUE- Koweït

30 000 m<sup>2</sup> de Barrisol® - 322917.31 sq ft of Barrisol® - 30 000 m<sup>2</sup> von Barrisol®

Phase 1



Design : NORR architects

Phase 2

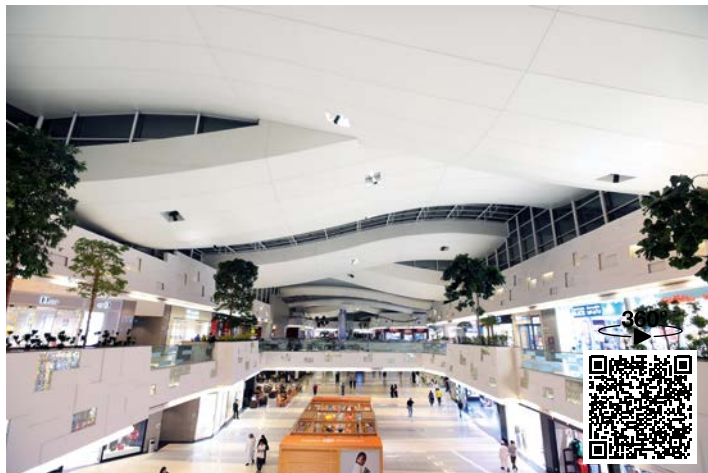

Design : NORR architects

Food court



Réalisation : Barrisol®

Phase 3



Arch. : Gensler

Phase 3



Arch. : Gensler



# Barrisol® Mini Star®



La Closerie by Delphine Jeangeorge



Le Mini Star® est la garantie d'une esthétique encore plus exceptionnelle. Une finition inégalée dans les plus petits détails tout en restant 100% totalement démontable.

Mini Star® is the guarantee of exceptional aesthetic beauty : the quality of the finish is unrivalled. Besides, and it can be completely dismantled.

Die Mini Star®-Leiste ist der Garant für eine außergewöhnliche Ästhetik. Sie bietet eine einzigartige Oberflächenqualität, selbst bis ins kleinste Detail rückbaubar.



Projet Office du Tourisme de Gent (Belgique) - arch. : Studio Arne Quinze



La Closerie by Delphine Jeangeorge



Arch. : Henning Larsen

Mini-Star® BMS340-11 mural - Mini-Star® BMS340-11 wall application - Mini-Star® BMS340-11 Wandleiste



Mini-Star® séparateur BMS350/21 - Mini-Star® séparateur BMS350/21 - Mini-Star® Trennleiste BMS350/21







1991  
MÉDAILLE DE BRONZE  
INNOVATION  
BATIMAT FRANCE

# Barrisol® Star®



Barrisol Star® et Barrisol Lumière® - design : Stefaan Onraet

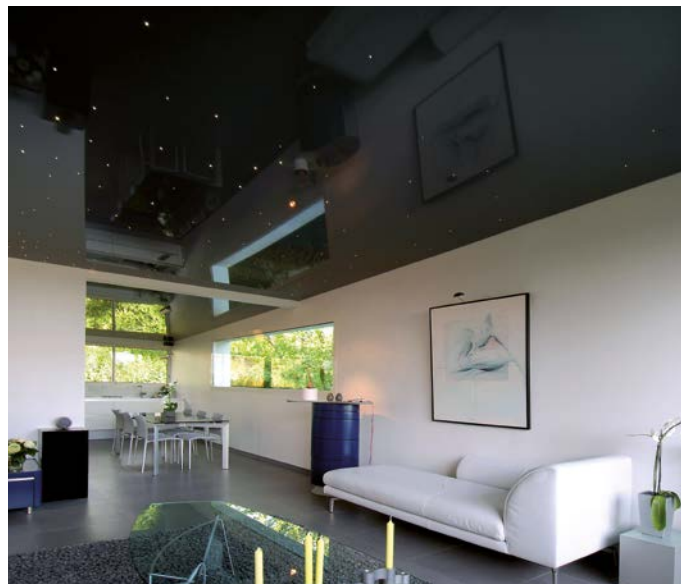

Barrisol Star® - réalisation : Essenciel

Barrisol Star® offre une finition parfaite et moderne pour la rénovation et la décoration de tous types de pièces. Le plafond est tendu de mur à mur sur lisses invisibles. Chaque plafond Barrisol® est fabriqué sur mesures aux formes exactes de la pièce à équiper.

La lisse Barrisol Star® est en aluminium 100 % recyclable. Elle peut être fixée sur la périphérie des murs ou directement au plafond. Elle est invisible après la pose du plafond tendu Barrisol®, seul un joint creux de quelques millimètres est apparent entre le mur et le plafond.

Barrisol Star® offers a perfect and modern finish to renovate and to decorate any types of interiorspace. The ceiling is stretched wall to wall on invisible tracks. Every Barrisol® ceiling is custom made to the exact measurements of the room. The Barrisol Star® track is made of 100 % recyclable aluminum. The tracks are fixed to the perimeter of the room, either on walls or ceilings as desired. After installation of the ceiling membrane, the tracks are invisible, only a hollow joint of some millimeters appears.

Barrisol Star® bietet eine perfekte und moderne Oberflächengestaltung bei Renovierung und Innenausstattung aller Räume. Die Decke wird von Wand zu Wand mit unsichtbaren Leisten gespannt. Jede Barrisol® Decke wird nach Maß in den genauen Formen des auszustattenden Raumes gefertigt.

Die Leiste Barrisol Star® besteht aus 100% recyclingfähigem Aluminium. Sie kann ringsherum an den Wänden oder direkt an der Zimmerdecke befestigt werden. Nach Einbringen der Barrisol® Spanndecke gibt es zwischen Wand und Decke nur eine einzige Hohlfluge von wenigen Millimetern.



Barrisol Star®



Barrisol Star® - réalisation : BEA Raphaël Pistilli

Mini-Star® BMS340-01

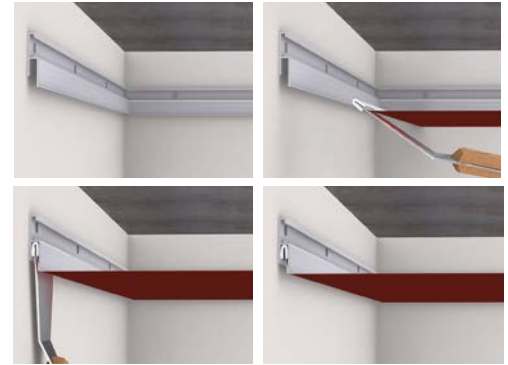

Mini-Star® séparateur BMS350/23 -

Mini-Star® separator BMS350/23 - Mini-Star® Trennleiste BMS350/23



Barrisol® Star® - arch. : Chapman Taylor Architetti



Barrisol Star® - réalisation : Mangiullo





1975  
MÉDAILLE D'ARGENT  
POUR L'INNOVATION  
BATIMAT FRANCE

# Barrisol® Tradition®



Réalisation : JJ. Rizotti

Barrisol Tradition® rénove et décore tous types de pièces. Le plafond est tendu de mur à mur sur lisses apparentes. Chaque plafond Barrisol® est fabriqué sur-mesure aux formes exactes de la pièce à équiper.

Barrisol Tradition® membranes renew and renovate all types of interior spaces. The ceiling is custom made to each specific room and is stretched from wall to wall on visible proprietary tracks.

Die traditionelle Barrisol® Folie erneuert und stattet alle Räume aus. Die Decke ist von Wand zu Wand auf sichtbaren Profile gespannt. Jede Decke wird auf Maß gefertigt.

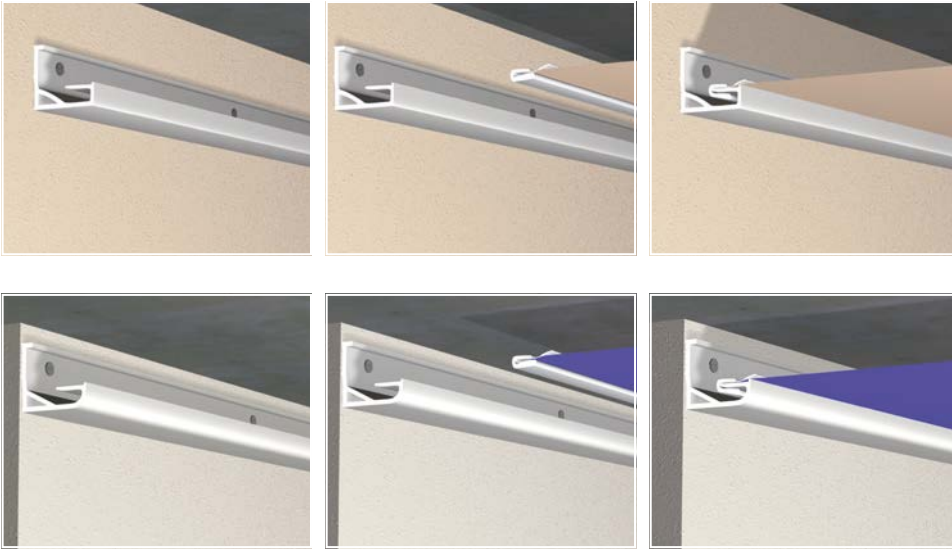

B 311

La lisse Barrisol Tradition® est en PVC 100% recyclable. Elle est fixée sur la périphérie des murs et reste apparente après la pose du plafond tendu. Elle est disponible en différents coloris selon la couleur de votre plafond Barrisol®.

The Barrisol Tradition® track is made of 100 % recyclable PVC. It is fixed to the walls and remains visible after the stretch ceiling installation. Tracks are available in various colours according to the colour of your Barrisol® ceiling.

Die Barrisol Tradition® Leiste besteht aus Kunststoff und ist zu 100% recycelbar. Sie wird entlang den Wänden des Raumes befestigt und bleibt nach Verlegung der Spanndecke sichtbar. Sie ist je nach Farbe der Decke in verschiedenen Farbtönen verfügbar.



Arch. : Jienarol Architecture



Réalisation : Barrisol®



# Technique ■ Technical ■ Technische

**Plafond - Ceiling - Decke | Tradition® B311**



**Plafond - Ceiling - Decke | Mini Star® BMS340-01**

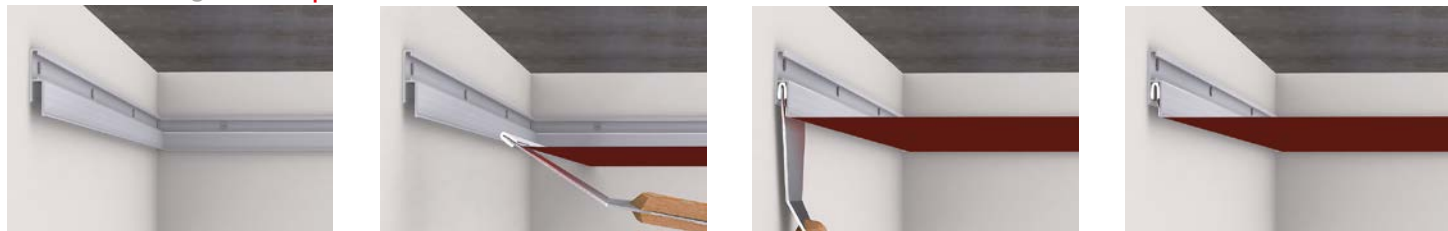

**Mur - Wall - Wande | Mini-Star® BMS340-11**



**Corniche - Cornice - Gesims | Star® BS350/06 & Séparateur - separator - Trennprofil | Mini-Star® BMS350/21**



**Séparateur - separator - Trennprofil | Mini-Star® BMS350/23**



**Cadre lumineux - Light frame - Leuchte Rahme | Mini Star® BMS355-15 Clip**



**Cadre lumineux - Light frame - Leuchte Rahme | Star® BS355-37**



**Ellipse - Ellipse - Ellipse | Mini Star®**



**Tunnel 3D - 3D tunnel - 3D Tunnel | Mini Star®**



**Cadre modulaire / vague - modular frame / wave - Modulrahmen / Welle | Mini Star®**

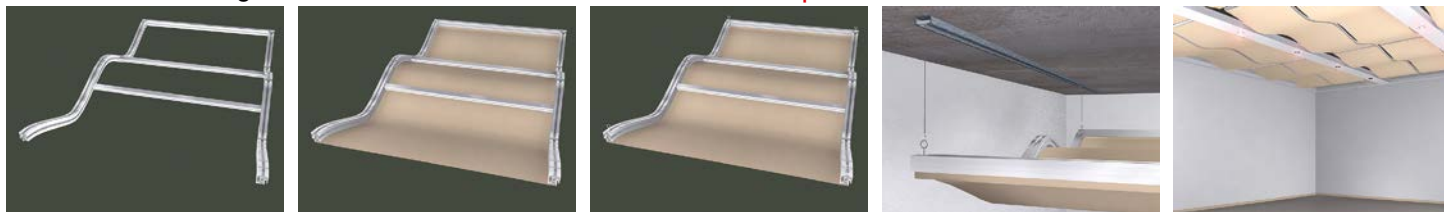



**Facettes 3D - 3D facets - 3D Facetten | Star® BS350/03**



**Séparateur pour rampant - Separator for rampant - Trennprofil für Dachschrägen | Star® BS350/16**



**Plafond lumineux double toile - Luminous ceiling double membrane - Leuchte Decke Doppelmembran | Star® BS355/10**



**Ensemble Barrispot® LED - Complete set Barrispot® LED - Vollständiger Barrispot® LED | B583 - B584 - B585 - B586**

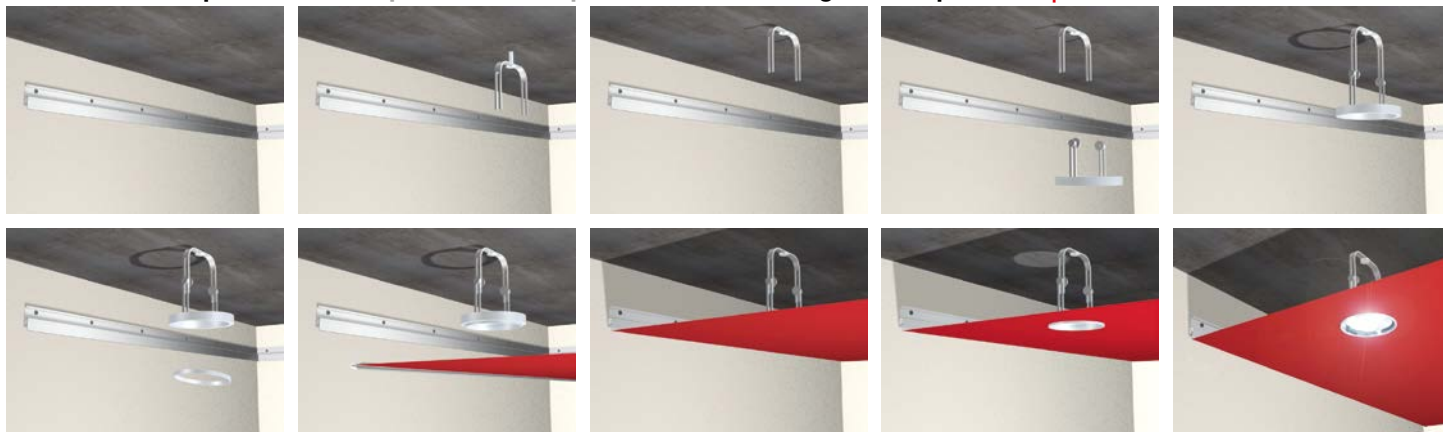

**Trempo® fixation par laçage - Trempo® fixation by lacing - Trempo Befestigung durch Spannen | BT310**



**Trempo® fixation par ressorts - Trempo® fixation by springs - Trempo Befestigung durch Federn | BT320**

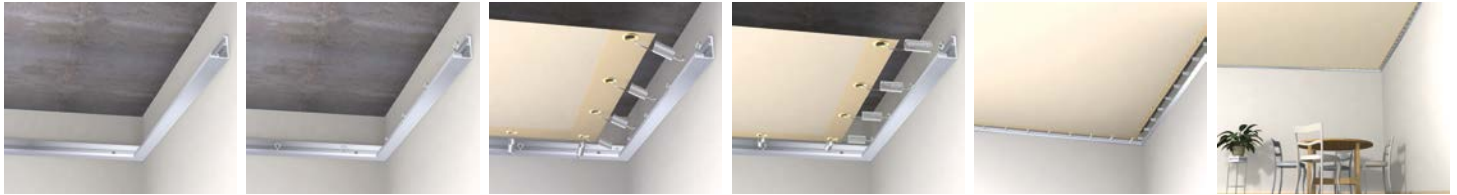

**Trempo® fixation par platine - Trempo® fixation by plate - Trempo Befestigung durch | BT600**



**artolis® by Barrisol® CSPR-4**







**artolis® by Barrisol® CSCL-1**



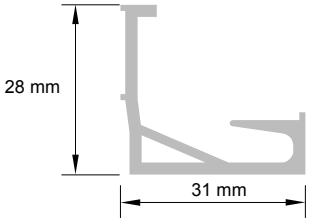
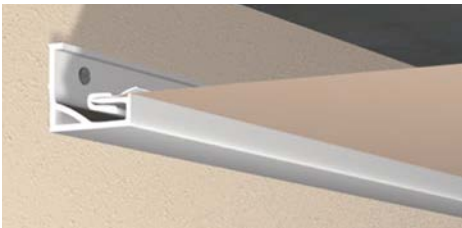
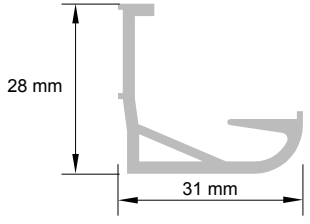
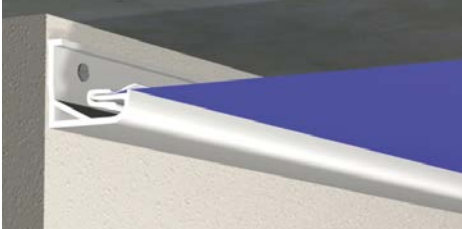
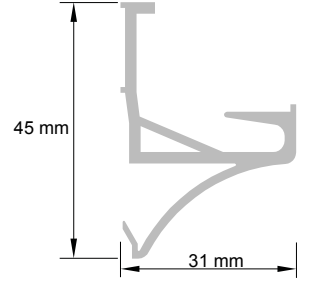

# Profils & éléments techniques

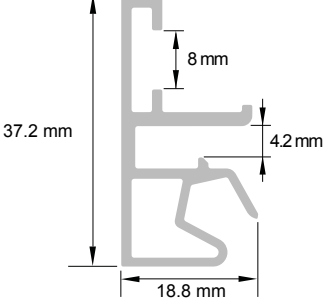
Rails systems - Leisten und Profile

<p><b>Ref.: B 301</b></p> <p>Lisse PVC PVC track Kunststoffleiste</p> <p>poids - weight - Gewicht : 0.240 kg/ml</p>		
<p><b>Ref.: B 311</b></p> <p>Lisse PVC PVC track Kunststoffleiste</p> <p>poids - weight - Gewicht : 0.224 kg/ml</p>		
<p><b>Ref.: B 320</b></p> <p>Lisse PVC PVC track Kunststoffleiste</p> <p>poids - weight - Gewicht : 0.330 kg/ml</p>		
<p><b>Ref.: B 321</b></p> <p>Lisse aluminium Aluminium track Aluminium Leiste</p> <p>poids - weight - Gewicht : 0.477 kg/ml</p>		

<p><b>Ref.: B 321/01</b></p> <p>Lisse PVC PVC track Kunststoffleiste</p> <p>poids - weight - Gewicht : 0.474 kg/ml</p> <p><b>Ref.: B 321/02</b></p> <p>Lisse PVC PVC track Kunststoffleiste</p> <p>poids - weight - Gewicht : 0.203 kg/ml</p>		
<p><b>Ref.: B 315</b></p> <p>Lisse aluminium Aluminium track Aluminium Leiste</p> <p>poids - weight - Gewicht : 0.757 kg/ml</p>		
<p><b>Ref.: B 316</b></p> <p>Lisse aluminium Aluminium track Aluminium Leiste</p> <p>poids - weight - Gewicht : 0.802 kg/ml</p>		



**Ref.: B 317/01**

Lisse aluminium  
Aluminium track  
Aluminium Leiste

poids - weight - Gewicht :  
1.039 kg/ml

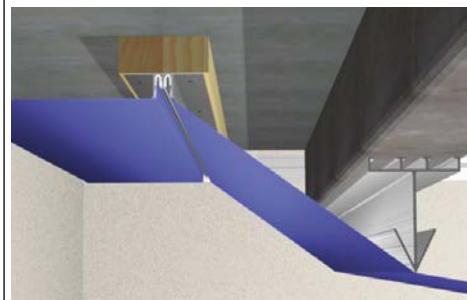
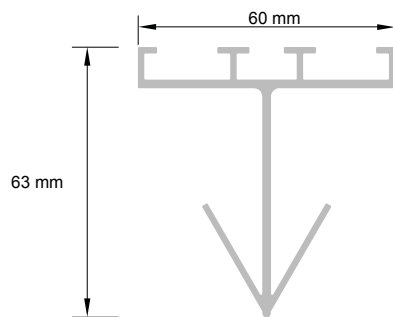

**Ref.: B 318/01**

Lisse aluminium  
Aluminium track  
Aluminium Leiste

poids - weight - Gewicht :  
0.664 kg/ml

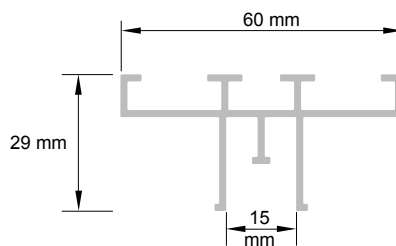

**Ref.: B 318/011**

Lisse aluminium  
Aluminium track  
Aluminium Leiste

poids - weight - Gewicht :  
0.194 kg/ml

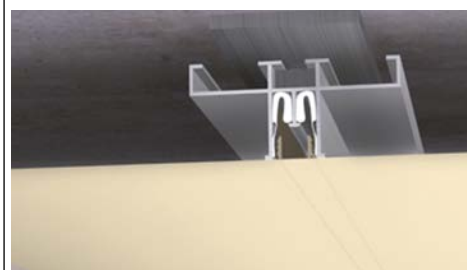
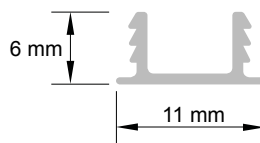







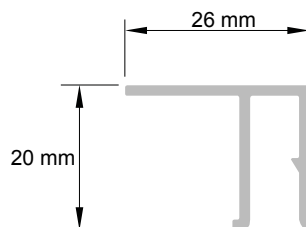

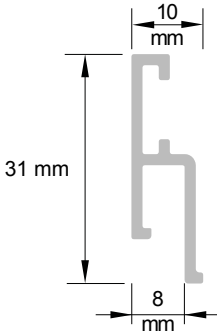
**Ref.: B 326/01**

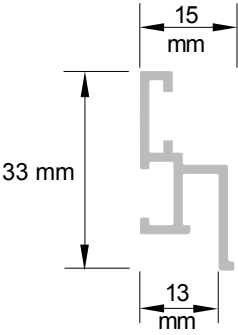
Lisse aluminium  
Aluminium track  
Aluminium Leiste

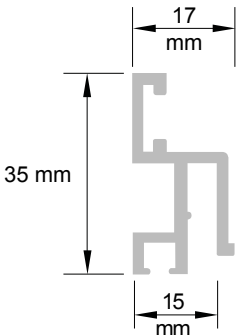
poids - weight - Gewicht :  
0.260 kg/ml

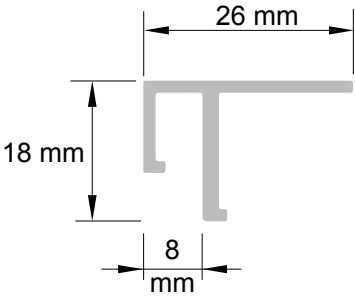

<p><b>Ref.: BS 350/01</b></p> <p>Lisse aluminium Aluminium track Aluminium Leiste</p> <p>poids - weight - Gewicht : 0.235 kg/ml</p>		
<p><b>Ref.: BS 350/04</b></p> <p>Lisse aluminium Aluminium track Aluminium Leiste</p> <p>poids - weight - Gewicht : 0.294 kg/ml</p>		
<p><b>Ref.: BS 350/05</b></p> <p>Lisse aluminium avec cimaise Aluminium track with suspension Aluminium Leiste mit Abhängevorrichtung</p> <p>poids - weight - Gewicht : 0.360 kg/ml</p>		
<p><b>Ref.: BS 350/11</b></p> <p>Lisse aluminium murale Aluminium wall track Aluminium Leiste</p> <p>poids - weight - Gewicht : 0.241 kg/ml</p>		



**Ref.: BS 350/61**

2 directions - 2 directions - 2 Richtungen

**Ref.: BS 350/62**

4 directions - 4 directions - 4 Richtungen

Lisse aluminium  
Aluminium track  
Aluminium Leiste

poids - weight - Gewicht :  
0.212 kg/ml

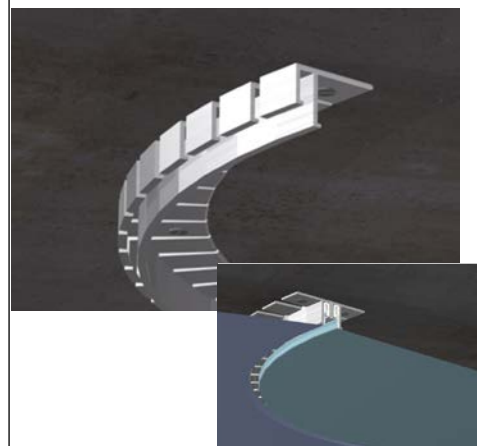
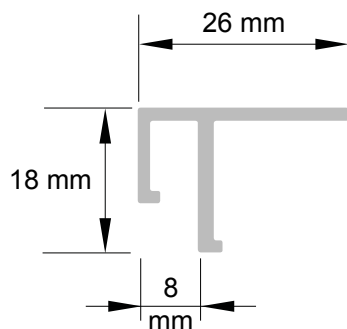

**Ref.: BS 350/06**

Lisse aluminium  
Aluminium track  
Aluminium Leiste

poids - weight - Gewicht :  
0.274 kg/ml

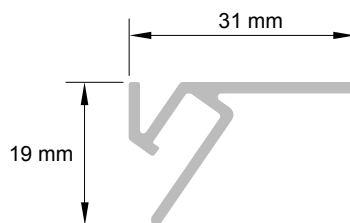

**Ref.: BS 350/16**

Séparateur aluminium  
Aluminium separator  
Aluminium Trennprofil

poids - weight - Gewicht :  
0.432 kg/ml

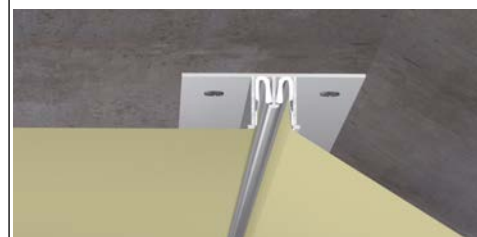
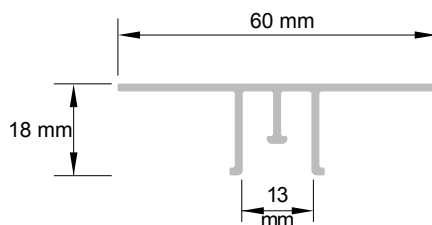

**Ref.: BS 350/66**

Séparateur aluminium  
Aluminium separator  
Aluminium Trennprofil

poids - weight - Gewicht :  
0.346 kg/ml  
Entaillé - Notch - Kerbe

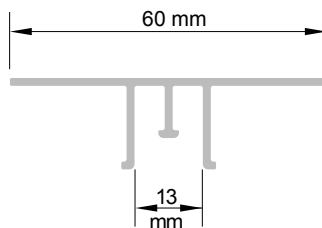

**Ref.: BS 350/23**

Séparateur aluminium  
Aluminium separator  
Aluminium Trennprofil

poids - weight - Gewicht :  
0.472 kg/ml

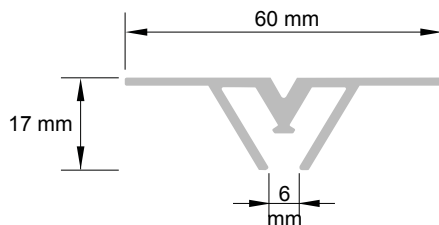

**Ref.: BS 350/21**

Séparateur aluminium 6 mm  
Aluminium separator 6 mm  
Aluminium Trennprofil 6 mm

poids - weight - Gewicht :  
0.483 kg/ml

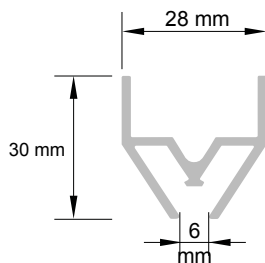

**Ref.: BS 350/24**

Séparateur lumière  
Light separator  
Licht Trennprofil

poids - weight - Gewicht :  
1.871 kg/ml

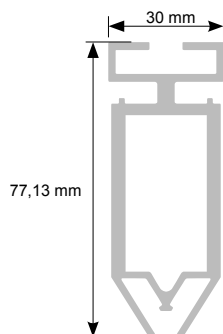



**Ref.: BS 350/20**

BS 350/201  
BS 350/202

Séparateur aluminium  
Aluminium separator  
Aluminium Trennprofil

poids - weight - Gewicht :  
0.837 kg/ml

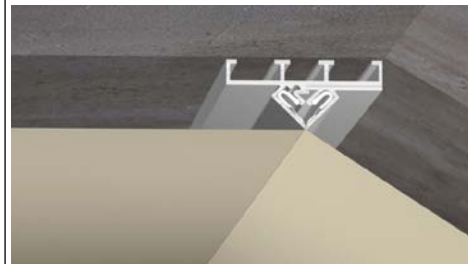
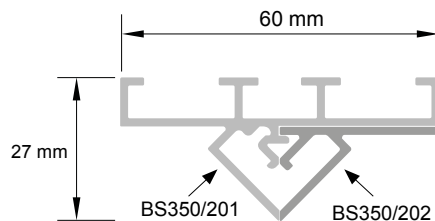

**Ref.: BS 350/18**

Séparateur aluminium pour  
cloisons et sprinklers  
Aluminium separator for partitions  
and sprinklers  
Aluminium Trennprofil für  
Trennwände und Sprinkler

poids - weight - Gewicht :  
1.037 kg/ml

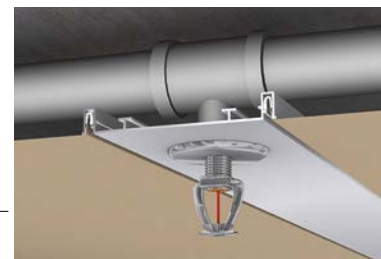



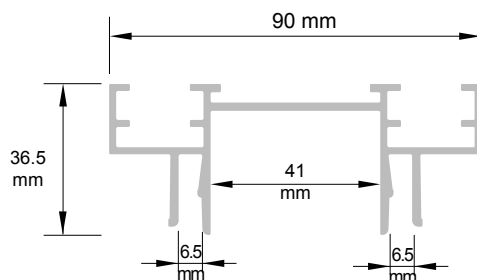

**Ref.: BS 350/19**

Séparateur aluminium en joint  
creux pour cloisons et sprinklers  
Aluminium separator for partitions  
and sprinklers  
Aluminium Trennprofil mit  
Schattenfuge für Trennwände  
und Sprinkler

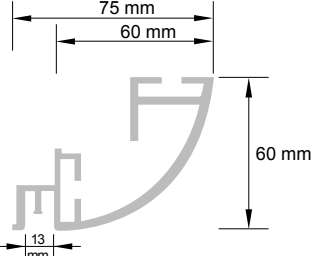
poids - weight - Gewicht :  
1.286 kg/ml

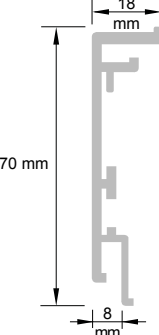

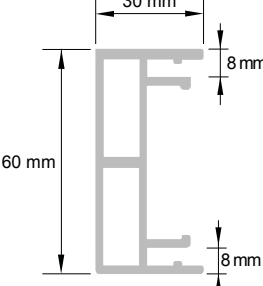
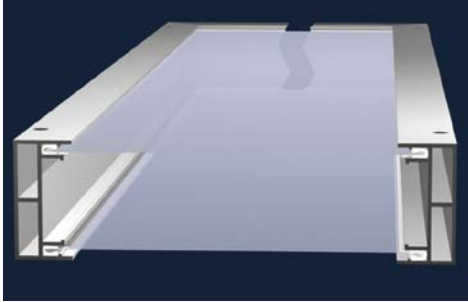
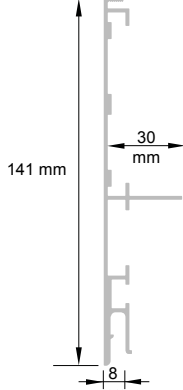
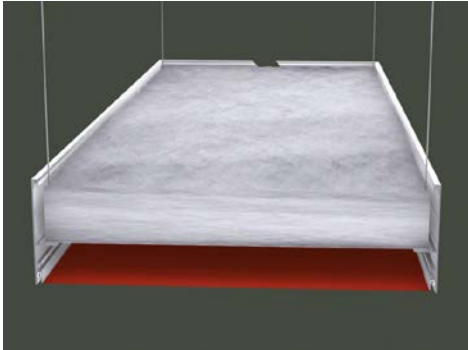
<p><b>Ref.: BS 350/165</b></p> <p>Séparateur aluminium Aluminium separator Aluminium Trennprofil</p> <p>poids - weight - Gewicht : 1.123 kg/ml</p>		
<p><b>Ref.: BS 350/10</b></p> <p>Profil aluminium mural double toile Double sheet wall aluminium profile Aluminium doppellagig Wandleiste</p> <p>poids - weight - Gewicht : 0.528 kg/ml</p>		
<p><b>Ref.: BS 355/163</b></p> <p>Profil aluminium pour cadre modulaire double toile Aluminium profile for double sheet modular frames Aluminium doppellagig Rahmenprofil</p> <p>poids - weight - Gewicht : 1.025 kg/ml</p>		
<p><b>Ref.: BS 355/02</b></p> <p>Lisse aluminium pour cadre modulaire Aluminium track for modular frames Aluminium Profil für Modulrahmen</p> <p>poids - weight - Gewicht : 1.130 kg/ml</p>		



**Ref.: BS 355/06**

Profil aluminium pour cadre modulaire  
 Aluminium profile for modular frames  
 Rahmenprofil

poids - weight - Gewicht :  
 0.861 kg/ml

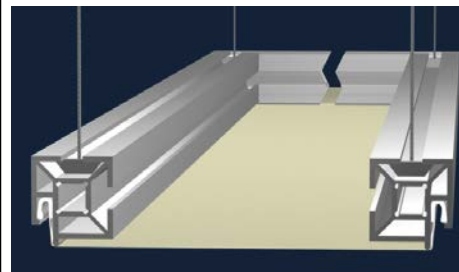
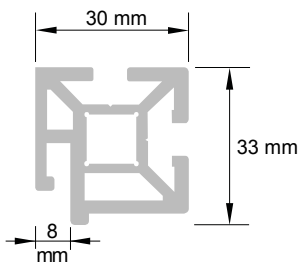

**Ref.: BS 355/04**

Lisse aluminium pour cadre modulaire  
 Aluminium track for modular frames  
 Aluminium Profil für Modulrahmen

poids - weight - Gewicht :  
 1.074 kg/ml

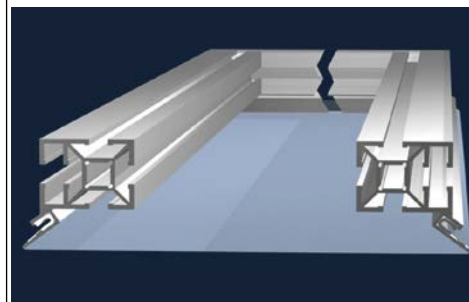
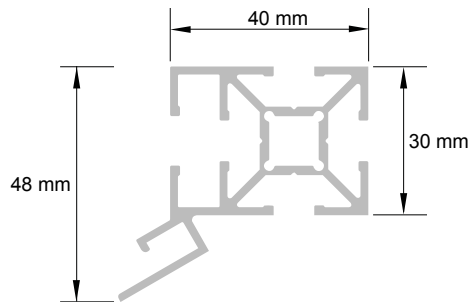

**Ref.: BS 355/17**

Profil aluminium pour cadre modulaire  
 Aluminium profile for modular frames  
 Aluminium Rahmenprofil

poids - weight - Gewicht :  
 1.161 kg/ml

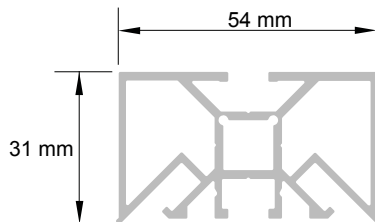

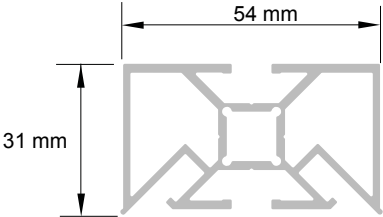
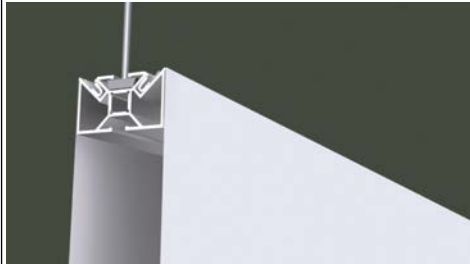
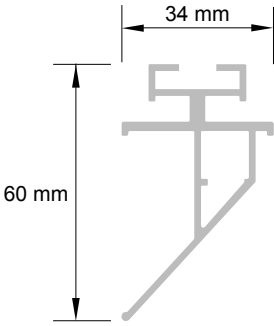
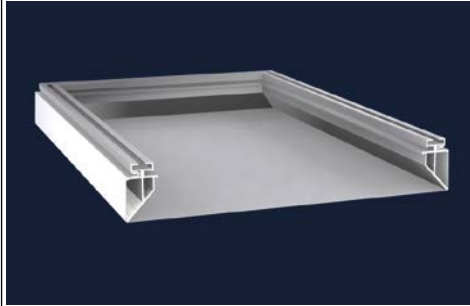
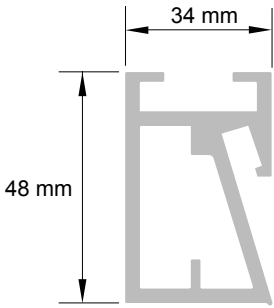
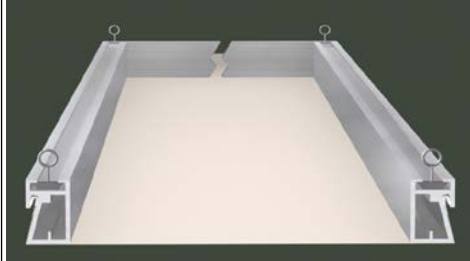
<p><b>Ref.: BS 355/18</b></p> <p>Profil aluminium pour cadre modulaire          Aluminium profile for modular frames          Aluminium Rahmenprofil</p> <p>poids - weight - Gewicht :          1.150 kg/ml</p>		
<p><b>Ref.: BS 355/45</b></p> <p>Profil aluminium pour cadre modulaire double toile          Aluminium profile for double sheet modular frames          Aluminium doppellagig Rahmenprofil</p> <p>poids - weight - Gewicht :          0.799 kg/ml</p>		
<p><b>Ref.: BS 355/55</b></p> <p>Profil aluminium pour cadre modulaire          Aluminium profile for modular frames          Aluminium Rahmenprofil</p> <p>poids - weight - Gewicht :          1.428 kg/ml</p>		



**Ref.: BS 355/05**

Système pour cadre modulaire  
System for modular frames  
Rahmenprofil System

poids - weight - Gewicht :  
0.806 kg/ml

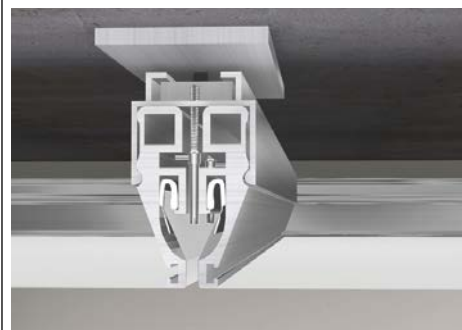
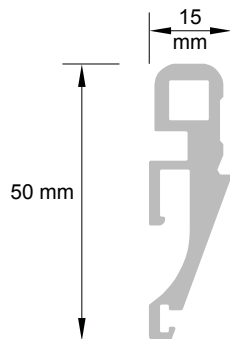

**Ref.: BS 355/08**

Profil aluminium pour cadre  
modulaire double toiture  
Aluminium profile for double  
sheet modular frames  
Rahmenprofil doppelaggi

poids - weight - Gewicht :  
1.120 kg/ml

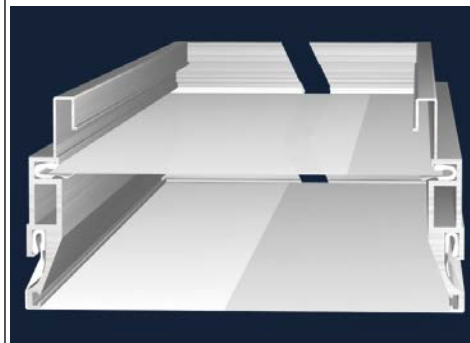
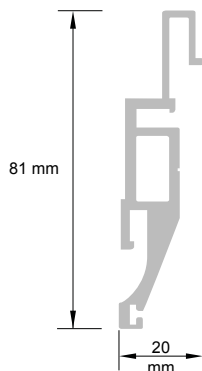



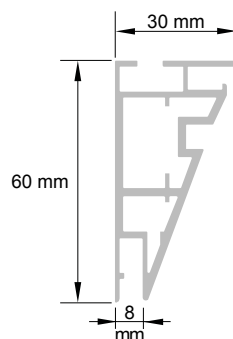

**Ref.: BS 355/14**

Profil aluminium pour cadre  
modulaire double toiture  
Aluminium profile for double  
sheet modular frames  
Rahmenprofil doppelaggi

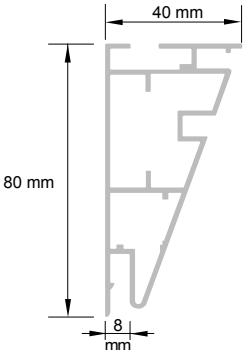
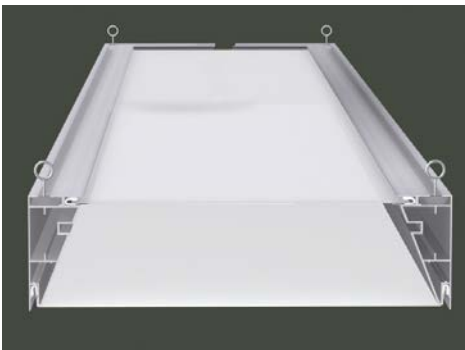
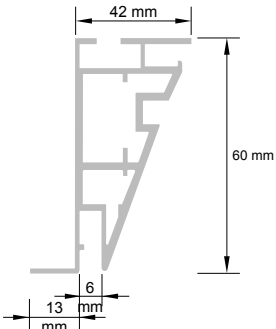
poids - weight - Gewicht :  
1.083 kg/ml

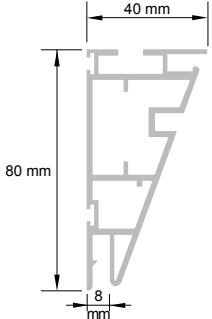

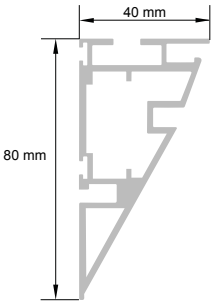
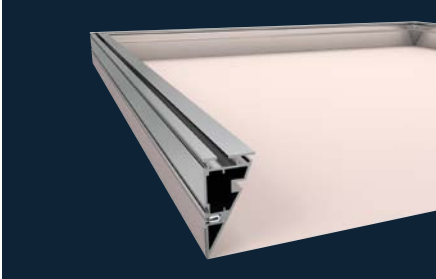
<p><b>Ref.: BS 355/15</b></p> <p>Profil aluminium pour cadre modulaire double toile                      Aluminium profile for double sheet modular frames                      Rahmenprofil doppellagi</p> <p>poids - weight - Gewicht :                      1.244 kg/ml</p>		
<p><b>Ref.: BS 355/22</b></p> <p>Séparateur aluminium                      Aluminium separator                      Aluminium Trennprofil</p> <p>poids - weight - Gewicht :                      1.011 kg/ml</p>		
<p><b>Ref.: BS 355/25</b></p> <p>Profil aluminium pour cadre modulaire double toile                      Aluminium profile for double sheet modular frames                      Aluminium doppellagig                      Rahmenprofil</p> <p>poids - weight - Gewicht :                      1.609 kg/ml</p>		
<p><b>Ref.: BS 355/37</b></p> <p>Profil aluminium pour cadre modulaire double toile                      Aluminium profile for double sheet modular frames                      Aluminium doppellagig                      Rahmenprofil</p> <p>poids - weight - Gewicht :                      1.555 kg/ml</p>		



**Ministar®**  
Ref.: BXS 330/11

Lisse aluminium  
Aluminium track  
Aluminium Leiste

poids - weight - Gewicht :  
0.183 kg/ml

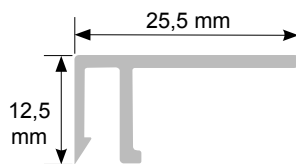

**Ministar®**  
Ref.: BMS 340/01

Lisse aluminium  
Aluminium track  
Aluminium Leiste

poids - weight - Gewicht :  
0.207 kg/ml

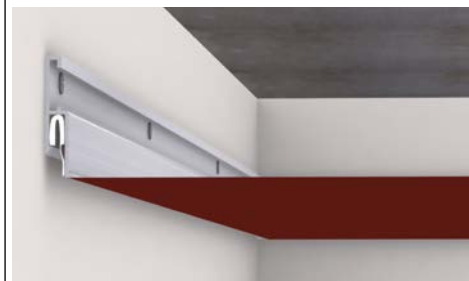
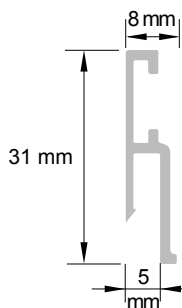

**Ministar®**  
Ref.: BMS 340/11

Lisse aluminium  
Aluminium track  
Aluminium Leiste

poids - weight - Gewicht :  
0.200 kg/ml

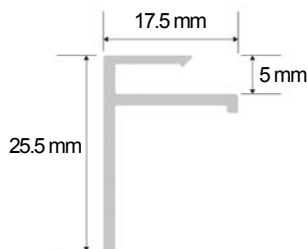



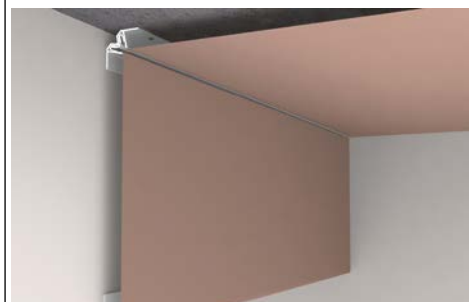
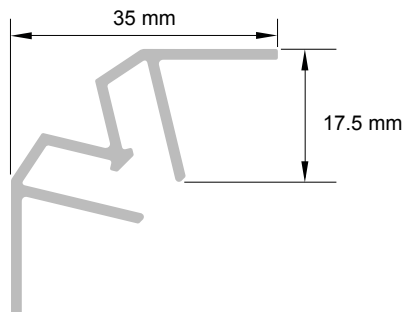

**Ministar®**  
Ref.: BMS 340/15

Séparateur aluminium mural  
d'angle  
Wall corner aluminium separator  
Wandabstandshalter Aluminium  
für Winkel

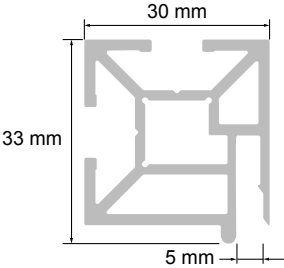
poids - weight - Gewicht :  
0.419 kg/ml

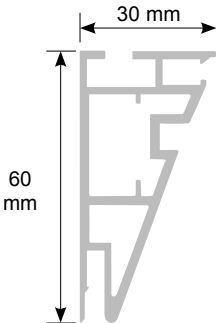

<p><b>Ministar®</b> <b>Ref.: BMS 340/24</b></p> <p>Séparateur d'angle aluminium Aluminium separator for corner Aluminium Trennprofil für Außenwinkel</p> <p>poids - weight - Gewicht : 0.644 kg/ml</p>		
<p><b>Ministar®</b> <b>Ref.: BMS 340/10</b></p> <p>Lisse aluminium double toile pour plafond lumineux Aluminium track for double layer lighting ceiling Trägertraverse Aluminium LED</p> <p>poids - weight - Gewicht : 0.564 kg/ml</p>		
<p><b>Ministar®</b> <b>Ref.: BMS 345/06</b></p> <p>Lisse aluminium Aluminium track Aluminium Leiste</p> <p>poids - weight - Gewicht : 0.859 kg/ml</p>		
<p><b>Ministar®</b> <b>Ref.: BMS 345/14</b></p> <p>Profil aluminium pour cadre modulaire double toile Aluminium profile for double layer modular frame Aluminium doppelagig Rahmenprofil</p> <p>poids - weight - Gewicht : 1.046 kg/ml</p>		



**Mini Star®**  
Ref.: BMS 345/55

Profil aluminium pour cadre  
modulaire triple voile  
Aluminium profile for triple layer  
modular frame  
Aluminium dreilagig Rahmenprofil

poids - weight - Gewicht :  
2.09 kg/ml

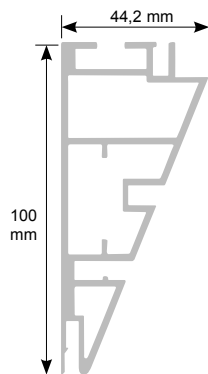

**Mini Star®**  
Ref.: BMS 345/20

Lisse aluminium  
Aluminium track  
Aluminium Leiste

poids - weight - Gewicht :  
1.241 kg/ml

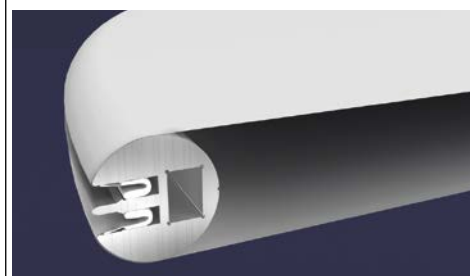
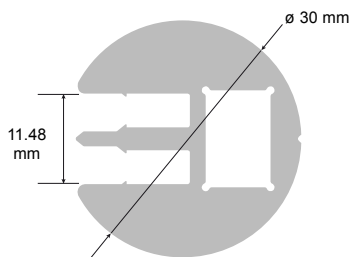

Ref.: BS 365/20

Tube aluminium double  
enclenchement  
Aluminium double sheet tube  
Aluminium Röhprofil für  
doppelfoli

poids - weight - Gewicht :  
1.470 kg/ml

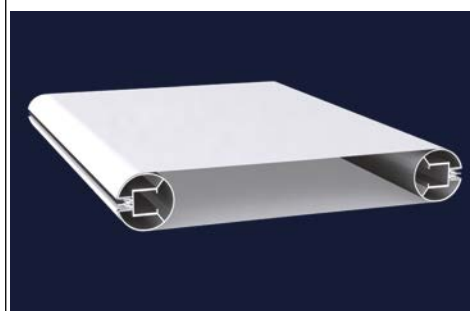
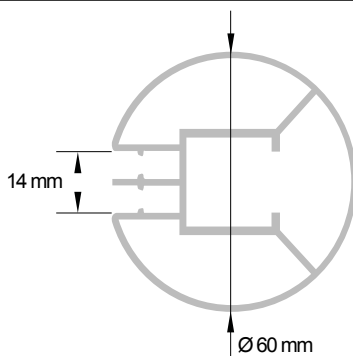

Ref.: BS 365/30

Tube aluminium tridirectionnel  
Aluminium tridirectionnel tube  
Aluminium tridirectionnel Röhre

poids - weight - Gewicht :  
1.662 kg/ml

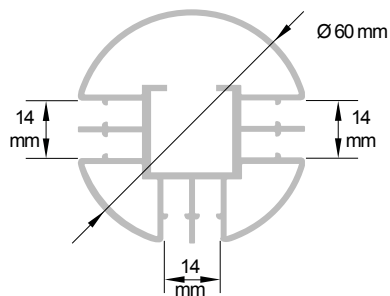

**Mini Star®**
**Ref.: BMS 345/28**
**LED**

Profil aluminium pour cadre  
 modulaire double toile  
 Aluminium profile for double layer  
 modular frame  
 Aluminium doppelagig  
 Rahmenprofil

poids - weight - Gewicht : 1.254 kg/ml

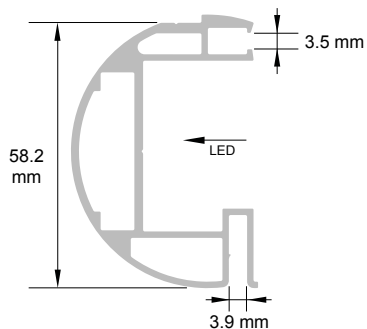
**Mini Star®**
**Ref.: BMS 345/29**
**LED**

Profil aluminium pour cadre modulaire  
 double toile  
 Aluminium profile for double layer  
 modular frame  
 Aluminium doppelagig Rahmenprofil

poids - weight - Gewicht : .172 kg/ml

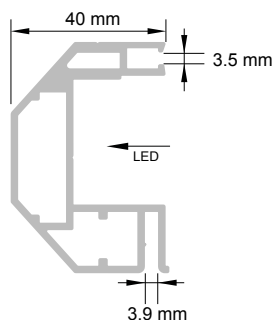
**Mini Star®**
**Ref.: BMS 365/40**
**LED**

Séparateur LED pour cercle et  
 forme 3D  
 LED separator for circle and 3D  
 shape  
 LED Trennzeichen für Kreis und  
 3D-Form

poids - weight - Gewicht : 1.867 kg/ml

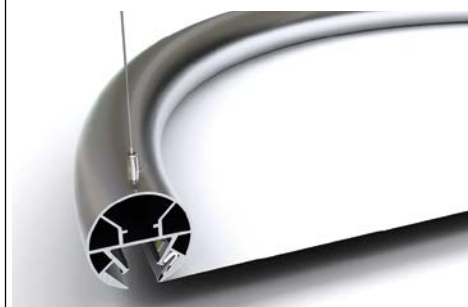
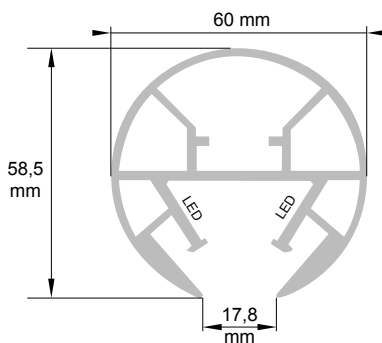



**Mini Star®**  
**Ref.: BMS 365/50**  
**LED**

Séparateur LED mur et plafond  
 LED wall and ceiling separator  
 LED Wand und Decken  
 Trennprofil.  
 poids - weight - Gewicht :  
 2.153 kg/ml

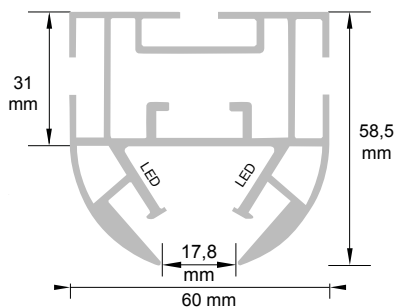

**Mini Star®**  
**Ref.: BMS 345/30**  
**LED**

Tube aluminium  
 pour cadre modulaire LED  
 Aluminium tube for modular frame LED  
 Aluminiumrohr für Modulrahmen LED

poids - weight - Gewicht :  
 1.19 kg/ml

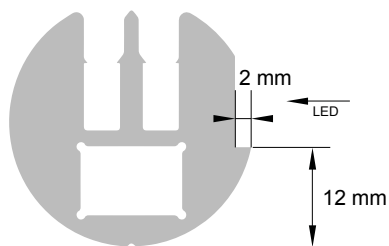







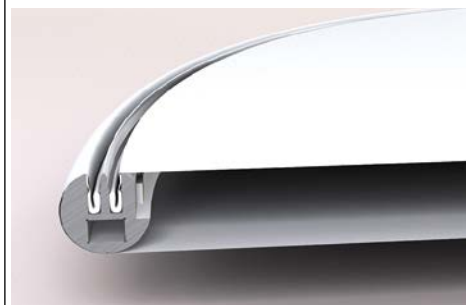
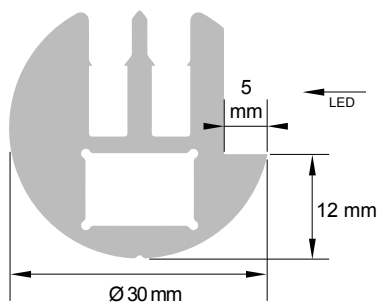

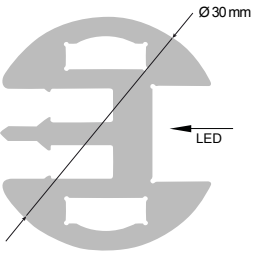
**Mini Star®**  
**Ref.: BMS 345/40**  
**LED**

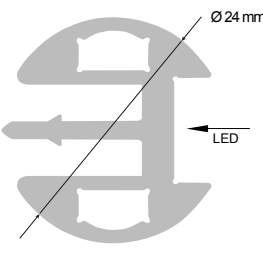
Tube aluminium  
 pour cadre modulaire LED  
 Aluminium tube for modular frame LED  
 Aluminiumrohr für Modulrahmen LED

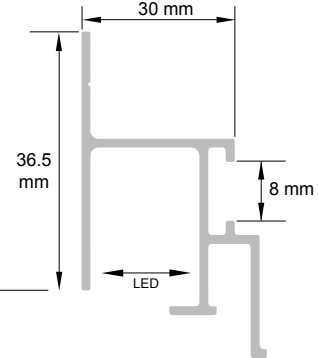
poids - weight - Gewicht :  
 1.085 kg/ml

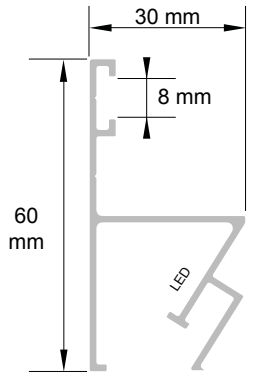

<p><b>Ref.: BMS 345/50</b>  <b>LED</b>                      Tube aluminium                      pour cadre modulaire LED                      Aluminium tube for modular frame                      LED                      Aluminiumrohr für Modulrahmen LED</p> <p>poids - weight - Gewicht :                      1.022 kg/ml</p>		
<p><b>Mini Star®</b>  <b>Ref.: BMS 335/50</b>  <b>LED</b>                      Tube aluminium                      pour cadre modulaire LED                      Aluminium tube for modular frame LED                      Aluminiumrohr für Modulrahmen LED</p> <p>poids - weight - Gewicht : 0.603 kg/ml</p>		
<p><b>Ref.: BS 350/13</b>  <b>LED</b>                      Lisse aluminium pour éclairage                      LEDpériphérique                      Aluminium track for perimeter LED                      lighting                      Trägertraverse Aluminium LED                      für Beleuchtungseinrichtung</p> <p>poids - weight - Gewicht : 0.462 kg/ml</p>		
<p><b>Mini Star®</b>  <b>Ref.: BMS 340/14</b>  <b>LED</b>                      Lisse aluminium pour éclairage LED                      périphérique                      Aluminium track for perimeter LED                      lighting                      Trägertraverse Aluminium LED                      für Beleuchtungseinrichtung</p> <p>poids - weight - Gewicht :                      0.616 kg/ml</p>		



**Trempo**  
**Ref.: BT 310**  
**Sandows**

Profil aluminium Trempo®  
 Aluminium Trempo® profile  
 Aluminium Trempo® Profil

poids - weight - Gewicht : 0.243 kg/ml

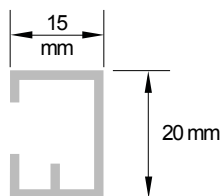

**Trempo**  
**Ref.: BT 320**  
**Ressorts - spring - Feder**

Profil aluminium Trempo®  
 Aluminium Trempo® profile  
 Aluminium Trempo® Profil

poids - weight - Gewicht : 0.437 kg/ml

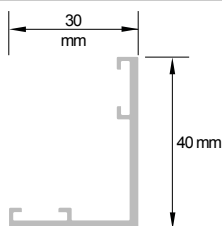

**Trempo**  
**Ref.: BT 330**  
**BT 330.01**  
**BT 330.02**

Profil aluminium Trempo®  
 Aluminium Trempo® profile  
 Aluminium Trempo® Profil

BT 330.01  
 poids - weight - Gewicht :  
 0.654 kg/ml

BT 330.02  
 poids - weight - Gewicht :  
 1.184 kg/ml

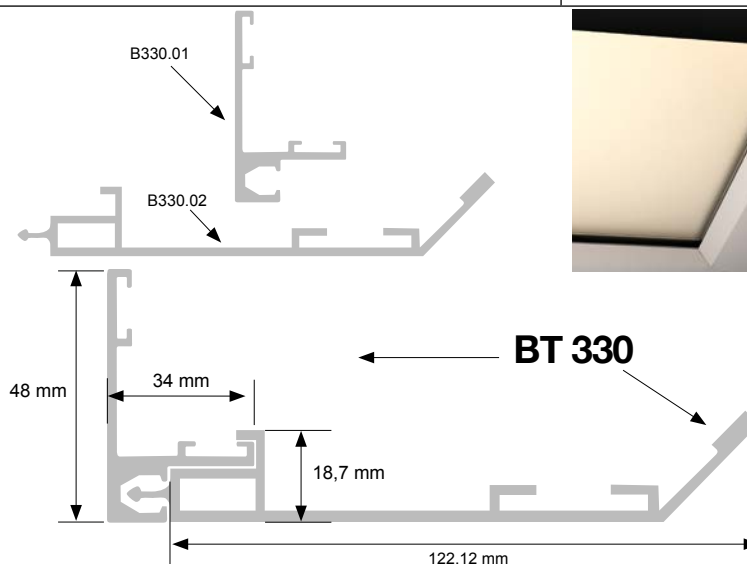

**Trempo**  
**Platine - plate - Platte**

Profil Trempo fixation platines  
 Trempo with plate fixation  
 Trempo Befestigung durch Platte

Différents modèles de fixation platine disponibles.  
 Different types of plate fixations available.  
 Verschiedene Befestigungselemente laut  
 der Projekt zu realisieren.

poids - weight - Gewicht : 1.307 kg/ml

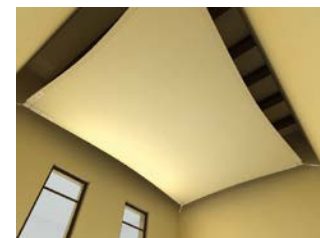

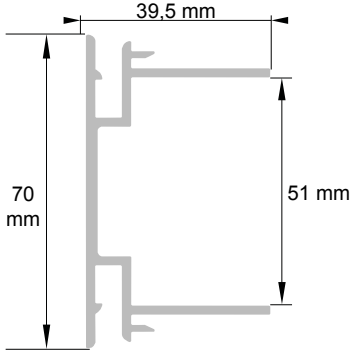
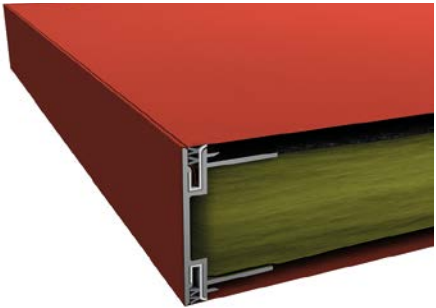
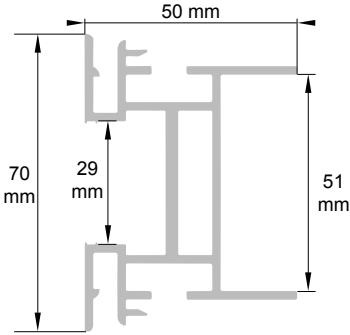
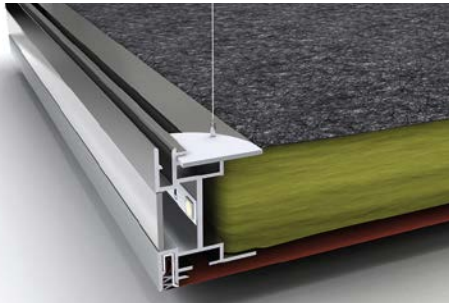
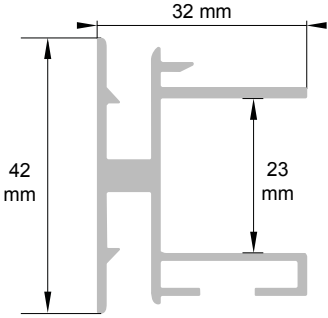
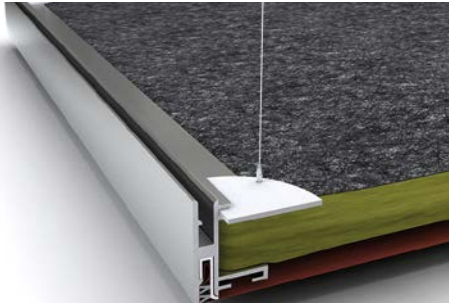
<p><b>Arcolis®</b>  <b>Ref.: ARCS - 10</b></p> <p>Profil aluminium pour cadre acoustique                  Aluminum profile for acoustic frame                  Aluminiumprofil für akustischen Rahmen</p> <p>poids - weight - Gewicht :                  1.050 kg/ml</p>		
<p><b>Arcolis®</b>  <b>Ref.: ARCS - 12</b></p> <p>Profil aluminium pour cadre acoustique avec chemin lumineux en périphérie                  Aluminum profile for acoustic frame                  Aluminiumprofil für akustischen Rahmen</p> <p>poids - weight - Gewicht :                  1.646 kg/ml</p>		
<p><b>Arcolis®</b>  <b>Ref.: ARCS - 13</b></p> <p>Profil aluminium pour cadre acoustique en hauteur mini                  Aluminum profile for acoustic frame height mini                  Aluminiumprofil für akustischen Rahmen Höhe mini</p> <p>poids - weight - Gewicht :                  0.851 kg/ml</p>		



**Clim®**

**Ref.: BXSClim312P**

Équerre perforée en aluminium  
 12 mm pour BXSClim312P  
 12mm aluminum perforated mounting  
 bracket for CLIM312P  
 Aluminium-Befestigungsbügel perforiert  
 12 mm für BXSClim312P  
 poids - weight - Gewicht :  
 1.60 kg/ml

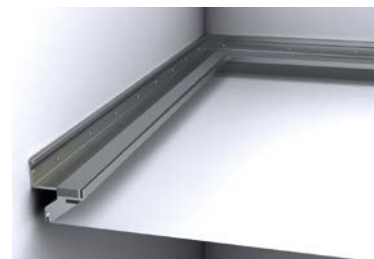
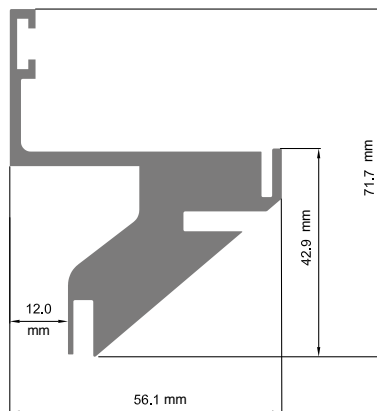

**Clim®**

**Ref.: BXSClim312**

Équerre en aluminium  
 12 mm pour BXSClim312  
 12mm aluminum mounting bracket  
 for CLIM312  
 Aluminium-Befestigungsbügel  
 12 mm für BXSClim312  
 poids - weight - Gewicht :  
 1.74 kg/ml

**Clim®**

**Ref.: BXSClim424P**

Équerre perforée en aluminium  
 24 mm pour BXSClim424P  
 24mm aluminum perforated mounting  
 bracket for BXSClim424P  
 Aluminium-Befestigungsbügel perforiert  
 24 mm für BXSClim424P  
 poids - weight - Gewicht :  
 1.61 kg/ml

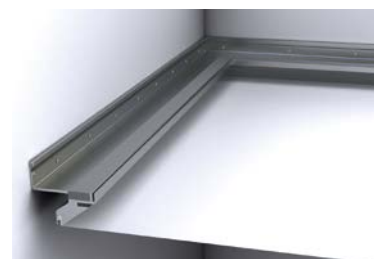
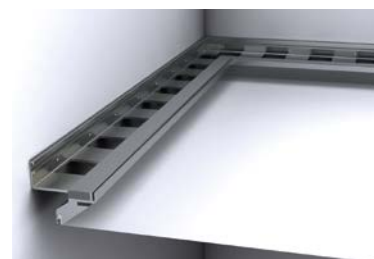
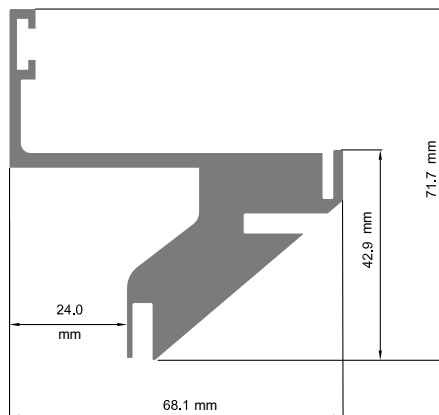

**Clim®**

**Ref.: BXSClim424**

Équerre en aluminium  
 24 mm pour BXSClim424  
 24mm aluminum mounting bracket  
 for BXSClim424  
 Aluminium-Befestigungsbügel  
 24 mm für BXSClim424  
 poids - weight - Gewicht :  
 1.84 kg/ml

**Clim®**

**Ref.: BXSCCLIM532P**

Équerre perforée en aluminium 32 mm  
pour BXSCCLIM532P

32mm aluminum perforated mounting  
bracket for BXSCCLIM532

Aluminium-Befestigungsbügel perforiert

32 mm für BXSCCLIM532

poids - weight - Gewicht :

1.63 kg/ml

**Clim®**

**Ref.: BXSCCLIM532**

Équerre en aluminium

32 mm pour BXSCCLIM532

32mm aluminum mounting bracket  
for BXSCCLIM532

Aluminium-Befestigungsbügel

32 mm für BXSCCLIM532

poids - weight - Gewicht :

1.90 kg/ml

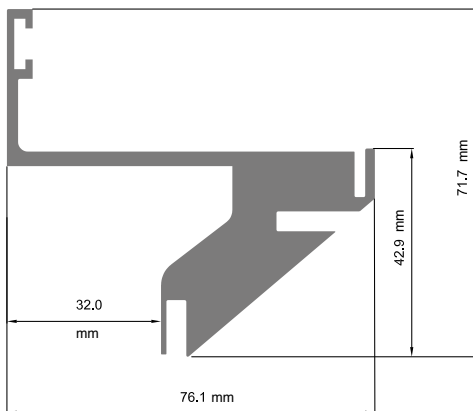

**Clim® extra small Harpon**

**Ref.: BXS103/08B**

Couleur / couleur / Farbe : Noir / Black /  
Schwarz

**Ref.: BXS103/09W**

Couleur / couleur / Farbe : Blanc / White /  
Weiß

Harpon en PVC

Harpoon in PVC

Kunststoffkeder

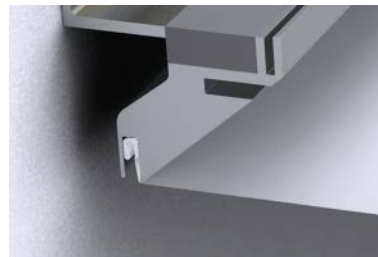
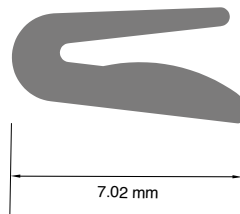

**Mirror®**

**Ref.: BMR 385/05**

Profil aluminium pour cadre modulaire  
Aluminium profile for modular frame  
Aluminium Rahmenprofil

poids - weight - Gewicht : 1.156 kg/ml

Accessoires - Accessories - Zubehör :

**BMR 385/06**

Profil aluminium  
Aluminium profile  
Aluminium Profil

poids - weight - Gewicht : 0.225 kg/ml

**BMR 385/07**

Profil aluminium  
Aluminium profile  
Aluminium Profil

poids - weight - Gewicht : 0.176 kg/ml

**B440/62**

Clip PVC

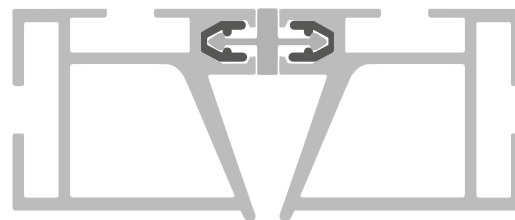
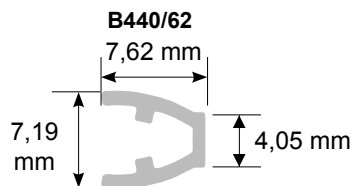
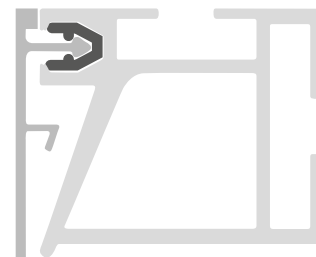
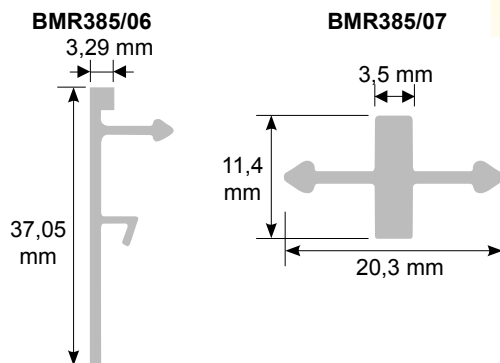
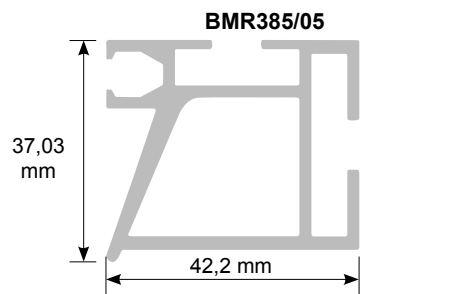



Mirror®

Ref. : BMR 385/01

Ref. : BMR 385/02

Profil aluminium pour cadre  
modulaire

Aluminium profile for modular frame

Aluminium Rahmenprofil

**BMR 385/01**

poids - weight - Gewicht :  
1.644 kg/ml

**BMR 385/02**

poids - weight - Gewicht :  
1.234 kg/ml

Accessoires - Accessories - Zubehör :

**BMR 385/03**

Profil aluminium  
Aluminium profile  
Aluminium Profil

poids - weight - Gewicht : 0.383 kg/ml

**BMR 385/04**

Profil aluminium  
Aluminium profile  
Aluminium Profil

poids - weight - Gewicht : 0.561 kg/ml

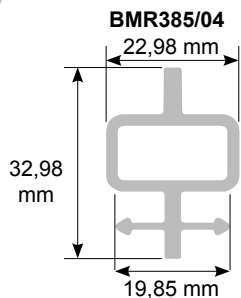
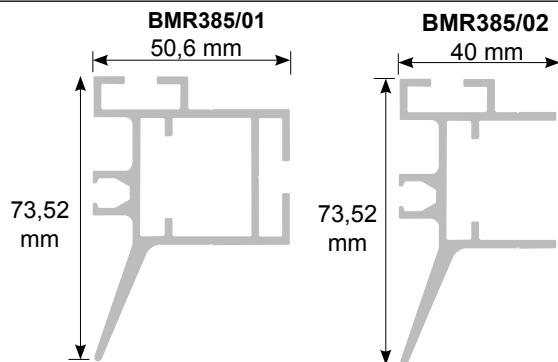

**B440/62**

Clip PVC

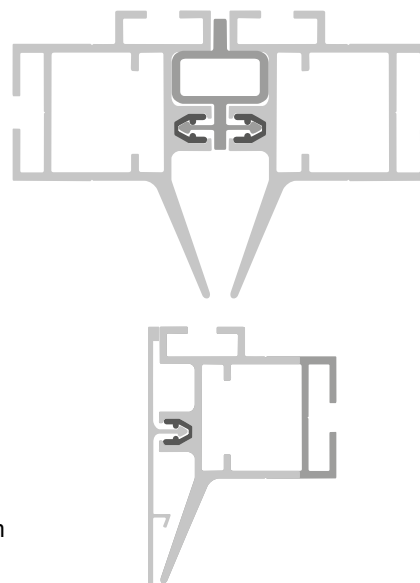
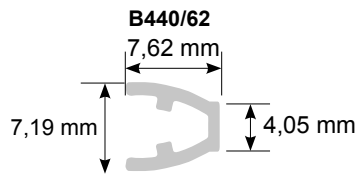
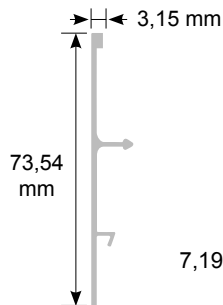

**BMR385/03**

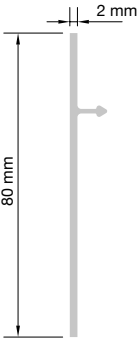
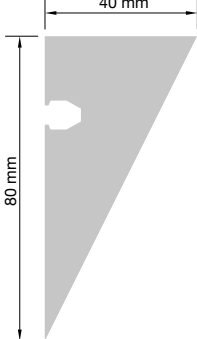
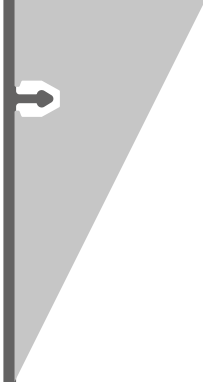

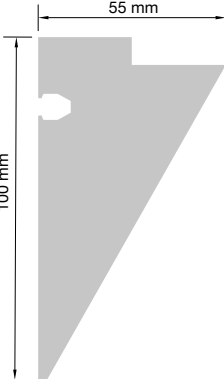
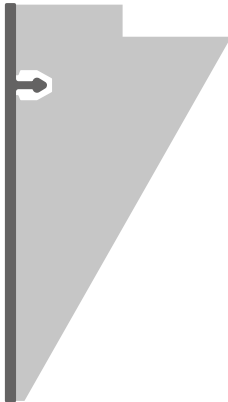
<p><b>GTS®</b>  <b>Ref. : BGMS 375/14</b>                      Ensemble / Set / Set                      poids - weight - Gewicht :                      2.51 kg/ml</p> <p><b>Ref. : BGMS 375/15</b>                      Profil aluminium pour cadre modulaire                      Aluminium profile for modular frame                      Aluminium Rahmenprofil</p> <p><b>Ref. : BGMS 375/16</b>                      Profil aluminium                      Aluminium profile                      Aluminium Profil</p>	<p>BGMS 375/16</p>  <p>BGMS 375/15</p> 	<p>BGMS 375/14</p> 
<p><b>GTS®</b>  <b>Ref. : BGMS 375/17</b>                      Ensemble / Set / Set                      poids - weight - Gewicht :                      4.05 kg/ml</p> <p><b>Ref. : BGMS 375/18</b>                      Profil aluminium pour cadre modulaire                      Aluminium profile for modular frame                      Aluminium Rahmenprofil</p> <p><b>Ref. : BGMS 375/19</b>                      Profil aluminium                      Aluminium profile                      Aluminium Profil</p>	<p>BGMS 375/19</p>  <p>BGMS 375/18</p> 	<p>BGMS 375/17</p> 

<p><b>GT<sup>®</sup></b>  <b>Ref. : BGTMS 375/26</b>                      Ensemble / Set / Set                      poids - weight - Gewicht :                      2.07 kg/ml  <b>Ref. : BGTMS 375/22</b>                      Profil aluminium pour cadre modulaire                      Aluminium profile for modular frame                      Aluminium Rahmenprofil  <b>Ref. : BGTMS 375/25</b>                      Profil aluminium                      Aluminium profile                      Aluminium Profil</p>	<p>BGTMS 375/25      BGTMS 375/22</p>	<p>BGTMS 375/26</p>
<p><b>GT<sup>®</sup></b>  <b>Réf. : BGTMS 375/20</b>                      Ensemble / Set / Set                      poids - weight - Gewicht :                      3.74 kg/ml  <b>Ref. : BGTMS 375/21</b>                      Profil aluminium pour cadre modulaire                      Aluminium profile for modular frame                      Aluminium Rahmenprofil  <b>Ref. : BGTMS 375/22</b>                      Profil aluminium pour cadre modulaire                      Aluminium profile for modular frame                      Aluminium Rahmenprofil  <b>Ref. : BGTMS 375/23</b>                      Profil aluminium                      Aluminium profile                      Aluminium Profil</p>	<p>BGTMS 375/23      BGTMS 375/21</p> <p>BGTMS 375/22</p>	<p>BGTMS 375/20</p>



**Artolis®**  
**Ref.: CSCL1**

Lisse PVC  
PVC track  
Kunststoffleiste

poids - weight - Gewicht :  
0.167 kg/ml

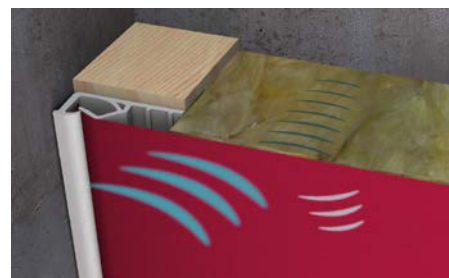
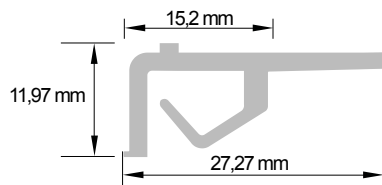

**Artolis®**  
**Ref.: CSPR2**

Lisse PVC  
PVC track  
Kunststoffleiste

poids - weight - Gewicht :  
0.136 kg/ml

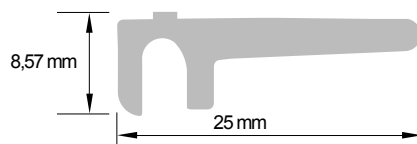

**Artolis®**  
**Ref.: CSPR4**

Lisse PVC  
PVC track  
Kunststoffleiste

poids - weight - Gewicht :  
0.324 kg/ml

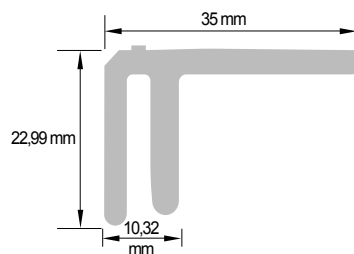

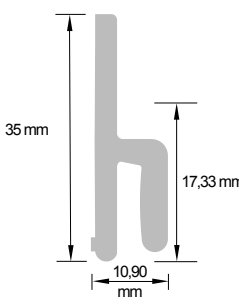
<p><b>Artolis®</b>  <b>Ref.: CSPR3</b>                  Lisse PVC                  PVC track                  Kunststoffleiste                  poids - weight - Gewicht :                  0.252 kg/ml</p>		
<p><b>Artolis®</b>  <b>Ref.: CSCL2</b>                  Lisse PVC                  PVC track                  Kunststoffleiste                  poids - weight - Gewicht :                  0.195 kg/ml</p>		
<p><b>Artolis®</b>  <b>Ref.: CSPR7</b>                  Lisse PVC                  PVC track                  Kunststoffleiste</p>		
<p><b>Artolis®</b>  <b>Ref.: CSCL 10</b>                  Lisse PVC                  PVC track                  Kunststoffleiste</p>		

# Reflet Laqué®

## Lacquered Reflection

### Die lackierte Lichtreflexion



Arch. : João Luis Carrilho



Design : Barrisol® Finland



**02018** Gris Tamaris\*<sup>(1)</sup>



**02011** Blanc Lys\*<sup>(1)</sup>/<sup>\*\*</sup>(<sup>2</sup>)



**02033** Brun Noisetier\*<sup>(1)</sup>



**02085** Rouge Grenat\*<sup>(2)</sup>



**02092** Rose Camélia\*<sup>(2)</sup>



**02019** Gris Erodium\*<sup>(2)</sup>

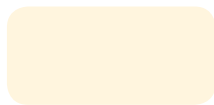

**02017** Beige Obione\*<sup>(1)</sup>



**02031** Brun Pomme de Pin\*<sup>(1)</sup>



**02083** Rouge Coquelicot\*<sup>(1)</sup>



**02091** Rose Azalée\*<sup>(2)</sup>



**02020** Gris Asarine\*<sup>(1)</sup>



**02024** Jaune Reseda\*<sup>(1)</sup>



**02041** Noir Tulipe\*<sup>(1)</sup>/<sup>\*\*</sup>(<sup>2</sup>)



**02082** Rouge Capucine\*<sup>(2)</sup>



**02090** Rose Fushia\*<sup>(1)</sup>



**02012** Gris Clématite\*<sup>(1)</sup>

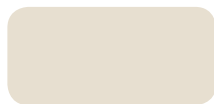

**02015** Beige Arum\*<sup>(1)</sup>



**02086** Violet Aubergine\*<sup>(2)</sup>



**02051** Orange Coulouma\*<sup>(1)</sup>



**02050** Mauve Iris\*<sup>(2)</sup>



**02016** Gris Ombelle\*<sup>(1)</sup>



**02013** Beige Magnolia\*<sup>(1)</sup>



**02081** Bordeaux Pivoine\*<sup>(1)</sup>



**02025** Orange Datura\*<sup>(1)</sup>



**02089** Violet Laelia\*<sup>(1)</sup>

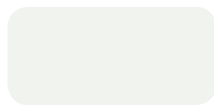

**02014** Gris Jasmin\*<sup>(2)</sup>



**02021** Beige Dactyle\*<sup>(1)</sup>



**02087** Brun Aurea\*<sup>(1)</sup>/<sup>\*\*</sup>(<sup>2</sup>)



**02022** Jaune Jonquille\*<sup>(2)</sup>



**02052** Mauve Aster\*<sup>(2)</sup>

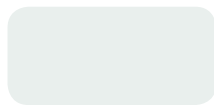

**02065** Vert Amandine\*<sup>(2)</sup>



**02030** Taupe Asaret\*<sup>(1)</sup>



**02088** Violet Gillia\*<sup>(2)</sup>



**02028** Terracota Ixia\*<sup>(2)</sup>



**02076** Bleu Belle de Nuit\*<sup>(1)</sup>

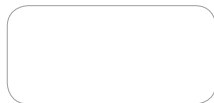

**02010** Blanc Orchidée\*<sup>(1)</sup>/<sup>\*\*</sup>(<sup>2</sup>)



**02032** Brun Roseaux\*<sup>(1)</sup>



**02084** Prune Violette\*<sup>(2)</sup>



**02053** Pêche Angélique\*<sup>(2)</sup>



**02075** Bleu Campanule\*<sup>(1)</sup>





Réalisation : Deco Design



Arch. : Ron Arad



**02072** Bleu Gentiane\*<sup>(1)</sup>



**02073** Bleu Bleuets\*<sup>(1)</sup>



**02074** Bleu Pervenche\*<sup>(2)</sup>



**02070** Bleu Dauphinoise\*<sup>(1)</sup>



**02071** Bleu Myosotis\*<sup>(2)</sup>



**02064** vert Amarante\*<sup>(2)</sup>



**02066** Vert Laurier\*<sup>(2)</sup>



**02067** Vert Olive\*<sup>(2)</sup>



**02062** Vert Houx\*<sup>(1)</sup>



**02069** Vert Aralia\*<sup>(2)</sup>



**02061** Vert Gui\*<sup>(2)</sup>



**02063** Vert Verveine\*\*<sup>(2)</sup>



**02068** Vert Lindera\*<sup>(2)</sup>



**02023** Jaune Primevère\*<sup>(1)</sup>



**02027** Jaune Cytise\*<sup>(2)</sup>

## ACOUSTICS®

A15 - A20 - A30 : ≤ 220 cm

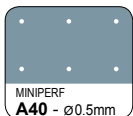
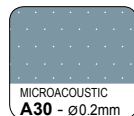
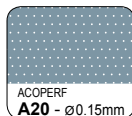
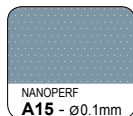

A40 : ≤ 200 cm.

Taux de réflexion de la lumière - Light reflexion rate  
Lichtreflexionsgrad - Tasso di riflessione della luce - Porcentaje de reflexión de luz

**02011** Blanc Lys

90%

Norme - Norm - Norm - Normativa - Normativa :

ASTM E903 - NF EN 410

## PERFORATIONS - PERFORATIONS - PERFORATIONEN - PERFORAZIONE - PERFORACIÓN

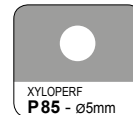
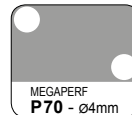
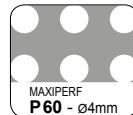
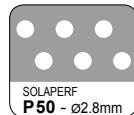
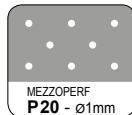
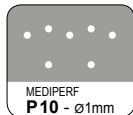

Classement au feu - Fire classification - Brandverhalten - Classe di reazione al fuoco - Clasificación al fuego <sup>(1)</sup>**B-s1, d0** <sup>(2)</sup>**B-s2, d0**

Largueur des lés - Sheet width - Folienbreite - Larghezza dei teli - Ancho de tela

A noter : des soudures sont possibles dans les plafonds en fonction des dimensions et configurations de projets - Please note : seams are possible on the ceilings depending on the projects dimensions and configuration. - Bemerkung : Nähte in der Spanndecke sind je nach Abmessungen und Projektkonfiguration möglich. - NB: Sarà possibile la presenza di saldature sui controsoffitti in base alla geometria e dimensioni dei teli e alle caratteristiche dei progetti. - A tener en cuenta : las soldaduras son posibles en función de las dimensiones o configuraciones de los proyectos.

**\*162 cm**  
150 cm

**\*\*214 cm**  
200 cm

Epaisseur - Thickness - Dicke - Spessore - Espesor

**17-18 / 100**



Le pourcentage de tension appliqué à la toile peut varier de 3 à 10% selon les contraintes liées à chaque projet - The percentage of tension applied to the sheet can vary from 3 to 10% depending on the constraints of each project - Die auf die Folie angebrachte Spannung kann von 3 bis 10% je nach den Projektbeschränkungen variieren - La percentuale di tensione applicata al telo può essere variabile dal 3 al 10% secondo le esigenze legate ad ogni progetto - El porcentaje de tensión aplicado a la tela puede variar entre el 3 y el 10% según las especificaciones técnicas a cada proyecto.

Les couleurs imprimées peuvent présenter un léger écart avec la réalité, notre carte d'échantillons est à votre disposition pour plus de précisions. - Printed colors may present a slight variation with the reality, our sample booklet is available for more precision. - Die gedruckten Farben können in der Realität von der Darstellung abweichen; eine Broschüre mit Muster ist für genauere Abgleiche erhältlich. - I colori riportati nella presente stampa possono presentare una leggera differenza dal materiale reale, la nostra campionatura è a vostra disposizione per facilitare la vostra scelta. - Dado que estos colores fueron impresos puede existir una diferencia con la realidad, por eso nuestra carta con muestras está a su disposición para una mayor precisión.



Les toiles de la gamme des Laqués, peuvent présenter de petites marques liées au processus de fabrication. Les reflets dans le laqué peuvent varier en fonction des formes, séparations et autres. En fonction de l'intensité de l'exposition au rayonnement solaire, de la composition de l'atmosphère de la pièce (lumière...), la teinte peut légèrement varier dans le temps. The reflections in the lacqued finish may vary depending on the shapes, separations and others. Small marks being a part of the manufacturing process may be present in the lacquered line. Depending on the intensity of the solar radiance exposition and the atmosphere composition (smoke...) of the room, the shade of the sheet may vary in the time. Der Spiegeleffekt der Lackfolien kann je nach Form, Aufteilung und weiteren Faktoren variieren. Die Lackdecken können kleine Druckstellen, verbunden mit dem Herstellungsprozess aufweisen. Abhängig von der Sonneneinstrahlung und der Luftzusammensetzung im Raum (Rauch...) kann sich das Erscheinungsbild der Folien zeitlich ändern. Il riflesso dei teli laccati può variare in funzione delle forme create e di varie condizioni ambientali. È possibile che i teli laccati presentino dei piccoli segni dovuti al processo di produzione del telo. In funzione dell'intensità dell'esposizione ai raggi del sole e della composizione dell'atmosfera della stanza (es: presenza di fumo), la tinta del telo può leggermente variare col tempo. Los reflejos de las telas lacadas pueden variar en función de las formas, separaciones y otros. Podrían aparecer ligeras marcas debido al proceso de fabricación en las telas lacadas. Según la intensidad de la exposición a la radiación solar, de la composición de la atmósfera de la habitación (humo...), el tinte puede variar con el tiempo.

# Rêves Satinés®

## Satin Dreams

### Die satinierte Lichtreflexion



Arch. : Jan kaplicky (Future Systems)  
et Andrea morgante (Shiro Studio)



Réalisation : Kordekor



**07097** Noir Blake\*\*\*<sup>(1)</sup>



**07010** Blanc Wight\*\*\*\*<sup>(1)</sup>



**07033** Beige Bahamas\*<sup>(2)</sup>



**07075** Bleu Fidji\*\*\*<sup>(1)</sup>



**07071** Vert Canaries\*<sup>(2)</sup>



**07018** Gris Célèbes\*\*\*<sup>(1)</sup>

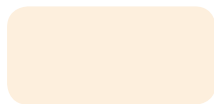

**07011** Ivoire Rhodes\*\*\*<sup>(1)</sup>



**07092** Rose Baléares\*<sup>(2)</sup>



**07074** Bleu Corfou\*<sup>(2)</sup>



**07063** Vert Antilles\*<sup>(2)</sup>



**07016** Gris Victoria\*\*\*<sup>(1)</sup>

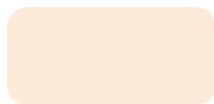

**07090** Rose Désirade\*<sup>(2)</sup>



**07093** Rose Tahiti\*<sup>(2)</sup>



**07073** Bleu Midway\*<sup>(2)</sup>



**07067** Vert Kourou\*\*<sup>(2)</sup>



**07017** Gris Livingstone\*\*\*<sup>(1)</sup>



**07091** Rose Marie Galante\*<sup>(2)</sup>



**07094** Rose Marquise\*\*\*<sup>(1)</sup>



**07072** Bleu Mayotte\*<sup>(2)</sup>



**07064** Vert Bermudes\*<sup>(2)</sup>

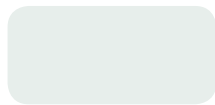

**07015** Gris Comores\*\*\*<sup>(1)</sup>

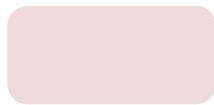

**07095** Rose Hawaï\*<sup>(2)</sup>



**07096** Rouge Aruba\*\*<sup>(2)</sup>

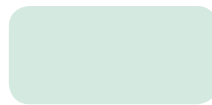

**07062** Vert Açores\*<sup>(2)</sup>



**07083** Brique Galapagos\*<sup>(2)</sup>



**07020** Blanc Artic\*\*\*<sup>(1)</sup>



**07019** Gris Seychelles\*\*\*<sup>(1)</sup>



**07084** Prune Kiji\*\*<sup>(2)</sup>



**07061** Bleu Palmyre\*<sup>(2)</sup>



**07082** Orange Bornéo\*<sup>(2)</sup>



Design : Latuner



Arch. : Moshe Safdie



**07081** Orange Sumatra\*(2)



**07024** Orange Bali\*(2)



**07023** Orange Java\*(2)



**07022** Orange Flores\*\*\*\*(1)



**07021** Jaune Ceylan\*\*\*\*(1)

### ACOUSTICS®

A15 - A20 - A30 : ≤ 220 cm

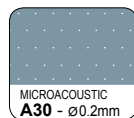
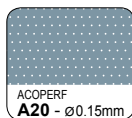
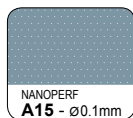

A40 : ≤ 200 cm.

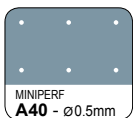

### Taux de réflexion de la lumière - Light reflexion rate

Lichtreflexionsgrad - Tasso di riflessione della luce - Porcentaje de reflexión de luz

<b>07010</b> Blanc Wight	89%
<b>07011</b> Ivoire Rhodes	81%

Norme - Norm - Norm - Normativa - Normativa :

ASTM E903 - NF EN 410

### PERFORATIONS - PERFORATIONS - PERFORATIONEN - PERFORAZIONE - PERFORACIÓN

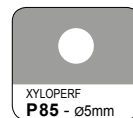
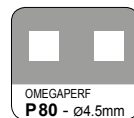
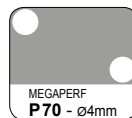
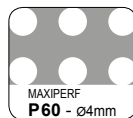
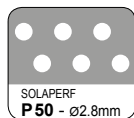
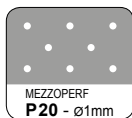
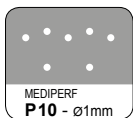

Classement au feu - Fire classification - Brandverhalten  
Classe di reazione al fuoco - Clasificación al fuego

(1) **B-s1, d0** | (2) **B-s2, d0**

Largeur des lés - Sheet width - Folienbreite - Larghezza dei teli - Ancho de tela

A noter : des soudures sont possibles dans les plafonds en fonction des dimensions et configurations de projets - Please note : seams are possible on the ceilings depending on the projects dimensions and configuration. - Bemerkung: Nähte in der Spanndecke sind je nach Abmessungen und Projektkonfiguration möglich. - NB: Sarà possibile la presenza di saldature sui controsoffitti in base alla geometria e dimensioni dei teli e alle caratteristiche dei progetti. - A tener en cuenta : las soldaduras son posibles en función de las dimensiones o configuraciones de los proyectos.

* <b>162 cm</b> ◀▶ 150 cm	** <b>214 cm</b> ◀▶ 200 cm	*** <b>236 cm</b> ◀▶ 220 cm	**** <b>240 cm</b> ◀▶ 225 cm
------------------------------	-------------------------------	--------------------------------	---------------------------------

Epaisseur - Thickness - Dicke - Spessore - Espesor

**17-18 / 100**



Certificat de conformitate CE  
N° 0071 - CPR - 14627 rev. 3

Le pourcentage de tension appliqué à la toile peut varier de 3 à 10% selon les contraintes liées à chaque projet - The percentage of tension applied to the sheet can vary from 3 to 10% depending on the constraints of each project - Die auf die Folie angebrachte Spannung kann von 3 bis 10% je nach den Projektbeschränkungen variieren - La percentuale di tensione applicata al telo può essere variabile dal 3 al 10% secondo le esigenze legate ad ogni progetto - El porcentaje de tensión aplicado a la tela puede variar entre el 3 y el 10% según las especificaciones técnicas a cada proyecto.



Les couleurs imprimées peuvent présenter un léger écart avec la réalité, notre carte d'échantillons est à votre disposition pour plus de précisions. - Printed colors may present a slight variation with the reality, our sample booklet is available for more precision. - Die gedruckten Farben können in der Realität von der Darstellung abweichen, eine Broschüre mit Mustern ist für genauere Abgleiche erhältlich - I colori riportati nella presente stampa possono presentare una leggera differenza dal materiale reale, la nostra campionatura è a vostra disposizione per facilitare la vostra scelta. - Dado que estos colores fueron impresos puede existir una diferencia con la realidad, por eso nuestra carta con muestras está a su disposición para una mayor precisión.

En fonction de l'intensité de l'exposition au rayonnement solaire, de la composition de l'atmosphère de la pièce (fumée...), la teinte peut légèrement varier dans le temps. - Depending on the intensity of the solar radiation exposure and the atmosphere composition (smoke...) of the room, the shade of the sheet may vary in the time. - Abhängig von der Sonneneinstrahlung und der Luftzusammensetzung im Raum (Rauch...) kann sich das Erscheinungsbild der Folien zeitlich ändern. - In funzione dell'intensità dell'esposizione ai raggi del sole e della composizione dell'atmosfera (fumo...) della stanza, la tinta del telo può leggermente variare col tempo. - Según la intensidad de la exposición a la radiación solar, de la composición de la atmósfera de la habitación (humo...), el tinte puede variar con el tiempo.



# Les Inspirations Satinées®

## Satin inspiration

## Die satinierten Inspirationen

*Uniquement pour  
les toiles perforées  
P30, P40, P90, P95*



Arch. : Hans Gunnar Kronsjö



**D02018** Gris Tamaris\*<sup>(1)</sup>



**D02011** Blanc Lys\*<sup>(1)</sup>/**\*\***(2)



**D02033** Brun Noisetier\*<sup>(1)</sup>



**D02085** Rouge Grenat\*<sup>(2)</sup>



**D02092** Rose Camélia\*<sup>(2)</sup>



**D02019** Gris Erodium\*<sup>(2)</sup>



**D02017** Beige Obione\*<sup>(1)</sup>



**D02031** Brun Pomme de Pin\*<sup>(1)</sup>



**D02083** Rouge Coquelicot\*<sup>(1)</sup>



**D02091** Rose Azalée\*<sup>(2)</sup>



**D02020** Gris Asarine\*<sup>(1)</sup>



**D02024** Jaune Reseda\*<sup>(1)</sup>



**D02041** Noir Tulipe\*<sup>(1)</sup>/**\*\***(2)



**D02082** Rouge Capucine\*<sup>(2)</sup>



**D02090** Rose Fushia\*<sup>(1)</sup>



**D02012** Gris Clématite\*<sup>(1)</sup>

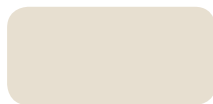

**D02015** Beige Arum\*<sup>(1)</sup>



**D02086** Violet Aubergine\*<sup>(2)</sup>



**D02051** Orange Coulouma\*<sup>(1)</sup>



**D02050** Mauve Iris\*<sup>(2)</sup>



**D02016** Gris Ombelle\*<sup>(1)</sup>



**D02013** Beige Magnolia\*<sup>(1)</sup>



**D02081** Bordeaux Pivoine\*<sup>(1)</sup>



**D02025** Orange Datura\*<sup>(1)</sup>



**D02089** Violet Laelia\*<sup>(1)</sup>



**D02014** Gris Jasmin\*<sup>(2)</sup>



**D02021** Beige Dactyle\*<sup>(1)</sup>



**D02087** Brun Aurea\*<sup>(2)</sup>



**D02022** Jaune Jonquille\*<sup>(2)</sup>



**D02052** Mauve Aster\*<sup>(2)</sup>

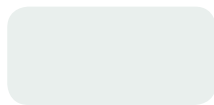

**D02065** Vert Amandine\*<sup>(2)</sup>



**D02030** Taupe Asaret\*<sup>(1)</sup>



**D02088** Violet Gilia\*<sup>(2)</sup>



**D02028** Terracota Ixia\*<sup>(2)</sup>



**D02076** Bleu Belle de Nuit\*<sup>(1)</sup>

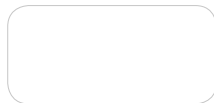

**D02010** Blanc Orchidée\*<sup>(1)</sup>/**\*\***(2)



**D02032** Brun Roseaux\*<sup>(1)</sup>



**D02084** Prune Violette\*<sup>(2)</sup>



**D02053** Pêche Angélique\*<sup>(2)</sup>



**D02075** Bleu Campanule\*<sup>(1)</sup>



Arch. : Dalibor Jurkovic



Arch. : Dolores Megar Noguera & Pedro Alcover Montaner

Gamme spécifique dédiée uniquement aux perforations P30, P40, P90, P95

This line is only available for perforations P30, P40, P90 and P95

Dieses Sortiment wird nur perforierten Folien P30, P40, P90 und P95 gewidmet

Gamma specifica dedicata solo alle perforazioni P30, P40, P90, P95

Gama específica dedicada solamente a las perforaciones P30, P40, P90, P95



**D02072** Bleu Gentiane<sup>\*(1)</sup>



**D02073** Bleu Bleuet<sup>\*(1)</sup>



**D02074** Bleu Pervenche<sup>\*(2)</sup>



**D02070** Bleu Dauphinelle<sup>\*(1)</sup>



**D02071** Bleu Myosotis<sup>\*(2)</sup>



**D02064** Vert Amarante<sup>\*(2)</sup>



**D02066** Vert Laurier<sup>\*(2)</sup>



**D02067** Vert Olive<sup>\*(2)</sup>



**D02062** Vert Houx<sup>\*(1)</sup>



**D02069** Vert Aralia<sup>\*(2)</sup>



**D02061** Vert Gui<sup>\*(2)</sup>



**D02063** Vert Verveine<sup>\*\*\*(2)</sup>



**D02068** Vert Lindera<sup>\*(2)</sup>



**D02023** Jaune Primevère<sup>\*(1)</sup>



**D02027** Jaune Cytise<sup>\*(2)</sup>

PERFORATIONS - PERFORATIONS - PERFORATIONEN - PERFORAZIONE - PERFORACIÓN

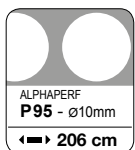
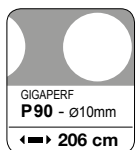
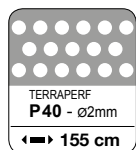
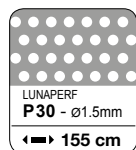

Classement au feu - Fire classification - Brandverhalten - Classe di reazione al fuoco - Clasificación al fuego

<sup>(1)</sup>**B-s1, d0**

<sup>(2)</sup>**B-s2, d0**

Largeur des lés - Sheet width - Folienbreite - Larghezza dei teli - Ancho de tela

A noter : des soudures sont possibles dans les plafonds en fonction des dimensions et configurations de projets - Please note : seams are possible on the ceilings depending on the projects dimensions and configuration. - Bemerkung: Nähte in der Spanndecke sind je nach Abmessungen und Projektkonfiguration möglich. - NB: Sarà possibile la presenza di saldature sui controsoffitti in base alla geometria e dimensioni dei teli e alle caratteristiche dei progetti. - A tener en cuenta : las soldaduras son posibles en función de las dimensiones o configuraciones de los proyectos.

**\*155 cm**

◀ ▶ 150 cm

**\*\*206 cm**

◀ ▶ 200 cm

Epaisseur - Thickness - Dicke - Spessore - Espesor

**36 / 100**



Certificat de conformitate CE  
N° 0071 - CPR - 14627 rev.3



◀ ▶ Le pourcentage de tension appliqué à la toile peut varier de 3 à 10% selon les contraintes liées à chaque projet - The percentage of tension applied to the sheet can vary from 3 to 10% depending on the constraints of each project - Die auf die Folie angebrachte Spannung kann von 3 bis 10% je nach den Projektbeschränkungen variieren - La percentuale di tensione applicata al telo può essere variabile dal 3 al 10% secondo le esigenze legate ad ogni progetto - El porcentaje de tensión aplicado a la tela puede variar entre el 3 y el 10% según las especificaciones técnicas a cada proyecto.

Les couleurs imprimées peuvent présenter un léger écart avec la réalité, notre carte d'échantillons est à votre disposition pour plus de précisions. - Printed colors may present a slight variation with the reality, our sample booklet is available for more precision. - Die gedruckten Farben können in der Realität von der Darstellung abweichen; eine Broschüre mit Muster ist für genauere Abgleiche erhältlich - I colori riportati nella presente stampa possono presentare una leggera differenza dal materiale reale, la nostra campionatura è a vostra disposizione per facilitare la vostra scelta - Dado que estos colores fueron impresos puede existir una diferencia con la realidad, por eso nuestra carta con muestras está a su disposición para una mayor precisión.

En fonction de l'intensité de l'exposition au rayonnement solaire, de la composition de l'atmosphère de la pièce (fumée...), la teinte peut légèrement varier dans le temps. Depending on the intensity of the solar radiation exposition and the atmosphere composition (smoke...) of the room, the shade of the sheet may vary in the time. Abhängig von der Sonneneinstrahlung und der Luftzusammensetzung im Raum (Rauch...) kann sich das Erscheinungsbild der Folien zeitlich ändern. In funzione dell'intensità dell'esposizione ai raggi del sole e della composizione dell'atmosfera (fumo...) della stanza, la tinta del telo può leggermente variare col tempo. Según la intensidad de la exposición a la radiación solar, de la composición de la atmósfera de la habitación (humo...), el tinte puede variar con el tiempo.

# Les Mat Tradition<sup>®</sup>

## Classic Matts

## Matt Klassik Tradition



Arch. : Manuelle Gautran Architecture



Arch. : Aedas Architects



**01050** Blanc Extramat<sup>\*\*\*(1)</sup>



**01060** Blanc Douceur<sup>\*\*\*(1)</sup>



**01020** Beige<sup>\*\*\*(1)</sup>



**01040** Noir<sup>\*\*\*(2)</sup>



**01016** Gris clair<sup>\*\*\*(1)</sup>

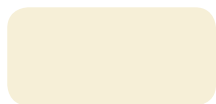

**01011** Ivoire<sup>\*\*\*(1)</sup>



**01030** Brun foncé<sup>\*\*\*(1)</sup>

### ACOUSTICS<sup>®</sup>

A15 - A20 - A30 : ≤ 220 cm

A40 : ≤ 200 cm.

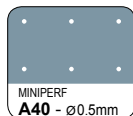
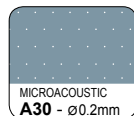
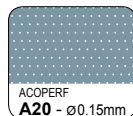
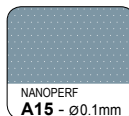

### PERFORATIONS - PERFORATIONS - PERFORATIONEN - PERFORAZIONE - PERFORACIÓN

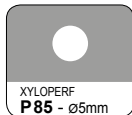
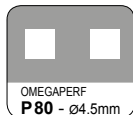
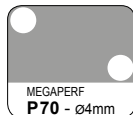
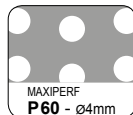
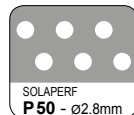
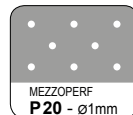
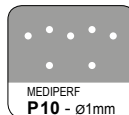

Classement au feu - Fire classification - Brandverhalten - Classe di reazione al fuoco -  
Clasificación al fuego

(1) **B-s1, d0**

(2) **B-s2, d0**

Largeur des lés - Sheet width - Folienbreite - Larghezza dei teli - Ancho de tela

A noter : des soudures sont possibles dans les plafonds en fonction des dimensions et configurations de projets - Please note : seams are possible on the ceilings depending on the projects dimensions and configuration. - Bemerkung: Nähte in der Spanndecke sind je nach Abmessungen und Projektkonfiguration möglich. - NB: Sarà possibile la presenza di saldature sui controsoffitti in base alla geometria e dimensioni dei teli e alle caratteristiche dei progetti. - A tener en cuenta : las soldaduras son posibles en función de las dimensiones o configuraciones de los proyectos.

**\*162 cm**

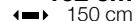

150 cm

**\*\*214 cm**

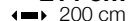

200 cm

**\*\*\*236 cm**

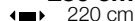

220 cm

Épaisseur - Thickness - Dicke - Spessore - Espesor

**17 - 18 / 100**



Certificat de conformitate CE  
N° 0021 - CPR - 14027 rev. 3



Le pourcentage de tension appliqué à la toile peut varier de 3 à 10% selon les contraintes liées à chaque projet - The percentage of tension applied to the sheet can vary from 3 to 10% depending on the constraints of each project - Die auf die Folie angebrachte Spannung kann von 3 bis 10% je nach den Projektbeschränkungen variieren - La percentuale di tensione applicata al telo può essere variabile dal 3 al 10% secondo le esigenze legate ad ogni progetto - El porcentaje de tensión aplicado a la tela puede variar entre el 3 y el 10% según las especificaciones técnicas a cada proyecto.

Les couleurs imprimées peuvent présenter un léger écart avec la réalité, notre carte d'échantillons est à votre disposition pour plus de précisions. - Printed colors may present a slight variation with the reality, our sample booklet is available for more precision. - Die gedruckten Farben können in der Realität von der Darstellung abweichen; eine Broschüre mit Muster ist für genauere Abgleiche erhältlich - I colori riportati nella presente stampa possono presentare una leggera differenza dal materiale reale, la nostra campionatura è a vostra disposizione per facilitare la vostra scelta - Dado que estos colores fueron impresos puede existir una diferencia con la realidad, por eso nuestra carta con muestras está a su disposición para una mayor precisión.

En fonction de l'intensité de l'exposition au rayonnement solaire, de la composition de l'atmosphère de la pièce (fumée...), la teinte peut légèrement varier dans le temps. Depending on the intensity of the solar radiance exposition and the atmosphere composition (smoke...) of the room, the shade of the sheet may vary in the time. Abhängig von der Sonneneinstrahlung und der Luftzusammensetzung im Raum (Rauch...) kann sich das Erscheinungsbild der Folien zeitlich ändern. In funzione dell'intensità dell'esposizione ai raggi del sole e della composizione dell'atmosfera (fumo...) della stanza, la tinta del telo può leggermente variare col tempo. Según la intensidad de la exposición a la radiación solar, de la composición de la atmósfera de la habitación (humo...), el tinte puede variar con el tiempo.



# Les Metals<sup>®</sup>

## Metals

## Metall



Arch. : MSM Design



Arch. : Michel Kutálek



**06023** Argenté



**06010** Fleur de métal



**06070** Vert métal



**06020** Laiton



**06090** Rose métal

### ACOUSTICS<sup>®</sup>

A15 - A20 - A30 : ≤ 220 cm

A40 : ≤ 200 cm.

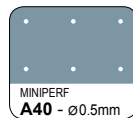
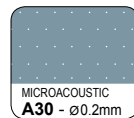
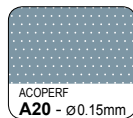
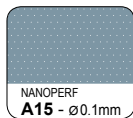

### PERFORATIONS - PERFORATIONS - PERFORATIONEN - PERFORAZIONE - PERFORACIÓN

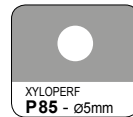
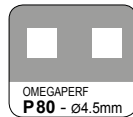
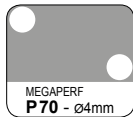
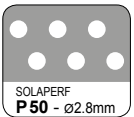
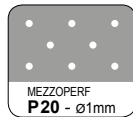
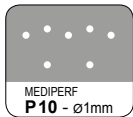

Classement au feu - Fire classification - Brandverhalten - Classe di reazione al fuoco - Clasificación al fuego

**B-s2, d0**

Largeur des lés - Sheet width - Folienbreite - Larghezza dei teli - Ancho de tela

A noter : des soudures sont possibles dans les plafonds en fonction des dimensions et configurations de projets - Please note : seams are possible on the ceilings depending on the projects dimensions and configuration. - Bemerkung: Nähte in der Spanndecke sind je nach Abmessungen und Projektkonfiguration möglich. - NB: Sarà possibile la presenza di saldature sui controsoffitti in base alla geometria e dimensioni dei teli e alle caratteristiche dei progetti. - A tener en cuenta : las soldaduras son posibles en función de las dimensiones o configuraciones de los proyectos.

**162 cm**  
↔ 150 cm

Epaisseur - Thickness - Dicke - Spessore - Espesor

**18 / 100**



Certificat de conformitate CE  
N° 0071 - CPR - 14627 rev. 3



↳ Le pourcentage de tension appliqué à la toile peut varier de 3 à 10% selon les contraintes liées à chaque projet - The percentage of tension applied to the sheet can vary from 3 to 10% depending on the constraints of each project - Die auf die Folie angebrachte Spannung kann von 3 bis 10% je nach den Projektbeschränkungen variieren - La percentuale di tensione applicata al telo può essere variabile dal 3 al 10% secondo le esigenze legate ad ogni progetto - El porcentaje de tensión aplicado a la tela puede variar entre el 3 y el 10% según las especificaciones técnicas a cada proyecto.

Les couleurs imprimées peuvent présenter un léger écart avec la réalité, notre carte d'échantillons est à votre disposition pour plus de précisions. - Printed colors may present a slight variation with the reality, our sample booklet is available for more precision. - Die gedruckten Farben können in der Realität von der Darstellung abweichen; eine Broschüre mit Muster ist für genauere Abgleiche erhältlich - I colori riportati nella presente stampa possono presentare una leggera differenza dal materiale reale, la nostra campionatura è a vostra disposizione per facilitare la vostra scelta. - Dado que estos colores fueron impresos puede existir una diferencia con la realidad, por eso nuestra carta con muestras está a su disposición para una mayor precisión.

En fonction de l'intensité de l'exposition au rayonnement solaire, de la composition de l'atmosphère de la pièce (fumée...), la teinte peut légèrement varier dans le temps. Depending on the intensity of the solar radiance exposition and the atmosphere composition (smoke...) of the room, the shade of the sheet may vary in time. Abhängig von der Sonneneinstrahlung und der Luftzusammensetzung im Raum (Rauch...) kann sich das Erscheinungsbild der Folien zeitlich ändern. In funzione dell'intensità dell'esposizione ai raggi del sole e della composizione dell'atmosfera (fumo...) della stanza, la tinta del telo può leggermente variare col tempo. Según la intensidad de la exposición a la radiación solar, de la composición de la atmósfera de la habitación (humo...), el tinte puede variar con el tiempo.

# Les Translucides® Translucent Die Lichtdurchlässigen



Arch. : Burdiefiek



Arch. : Paq Arquitectos



**04072** Planète Bleue\*\*\*<sup>(2)</sup>



**04011** Blanc Vénus\*\*\*<sup>(1)</sup>

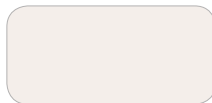

**04013** Clair de Lune\*\*\*<sup>(2)</sup>

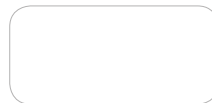

**04014** Calisto Translucide\*\*\*\*<sup>(2)</sup>

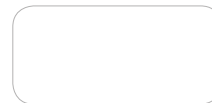

**04015** Mercure\*\*\*\*<sup>(2)</sup>

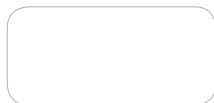

**04016** Sedna\*\*\*\*<sup>(2)</sup>



**04025** Aurore Boréale\*\*\*<sup>(2)</sup>



**04030** Athena\*\*\*\*<sup>(1)</sup>

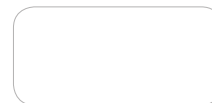

**04018** Plutonia\*\*\*\*<sup>(2)</sup>



**04010** Néréide\*<sup>(2)</sup>

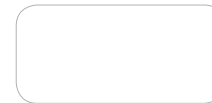

**04060** Antares\*\*\*\*<sup>(1)</sup>



**04080** Polaris\*\*\*\*<sup>(1)</sup>

## ACOUSTICS®

A15 - A20 - A30 : ≤ 220 cm

A40 : ≤ 200 cm.

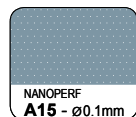

**NANOPERF**  
**A15** - ø0.1mm

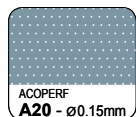

**ACOPERF**  
**A20** - ø0.15mm

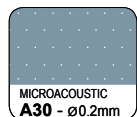

**MICROACOUSTIC**  
**A30** - ø0.2mm

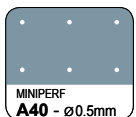

**MINIPERF**  
**A40** - ø0.5mm

## PERFORATIONS - PERFORATIONS - PERFORATIONEN PERFORAZIONE - PERFORACIÓN

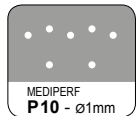

**MEDIPERF**  
**P10** - ø1mm

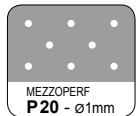

**MEZZOPERF**  
**P20** - ø1mm



**SOLAPERF**  
**P50** - ø2.8mm



**MAXIPERF**  
**P60** - ø4mm

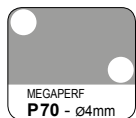

**MEGAPERF**  
**P70** - ø4mm

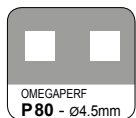

**OMEGAPERF**  
**P80** - ø4.5mm

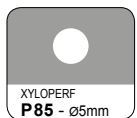

**XYLOPERF**  
**P85** - ø5mm

## Taux de transmission et de réflexion de la lumière - Light transmission and reflexion rate Lichtverbreitungsgrad und Lichtreflexionsgrad - Tasso di trasmissione e riflessione della luce Porcentaje de transmisión y reflexión de la luz

	Transmission - Transmission - Verbreitung	Réflexion - Reflexion - Reflexion
	Trasmisione - Trasmisión	Riflessione - Reflexión
Norme - Norm - Norm - Normativa - Normativa : ASTM E903 - NF EN 410		
<b>04072</b> Planète Bleue	11%	17%
<b>04011</b> Blanc Vénus	46%	56%
<b>04013</b> Clair de Lune	50%	46%
<b>04014</b> Calisto	42%	59%
<b>04015</b> Mercure	50%	46%
<b>04016</b> Sedna	49%	51%
<b>04025</b> Aurore Boréale	32%	61%
<b>04030</b> Athéna	48%	48%
<b>04018</b> Plutonia	44%	51%
<b>04010</b> Nereide	90%	10%
<b>04080</b> Polaris	77%	21%

Classement au feu - Fire classification - Brandverhalten -  
Classe di reazione al fuoco - Clasificación al fuego

<sup>(1)</sup>B-s1, d0 | <sup>(2)</sup>B-s2, d0

Largeur des lés - Sheet width - Folienbreite - Larghezza dei teli - Ancho de tela

A noter : des soudures sont possibles dans les plafonds en fonction des dimensions et configurations de projets - Please note : seams are possible on the ceilings depending on the projects dimensions and configuration. - Bemerkung : Nähte in der Spanndecke sind je nach Abmessungen und Projektkonfiguration möglich. - NB: Sarà possibile la presenza di saldature sui controsoffitti in base alla geometria e dimensioni dei teli e alle caratteristiche dei progetti. - A tener en cuenta : las soldaduras son posibles en función de las dimensiones o configuraciones de los proyectos.

\***145 cm** | \*\***162 cm** | \*\*\***214 cm** | \*\*\*\***235 cm** | \*\*\*\*\***256 cm**  
 ◀▶ 135 cm | ▶▶ 150 cm | ▶▶▶ 200 cm | ▶▶▶▶ 220 cm | ▶▶▶▶▶ 240 cm

Epaisseur - Thickness - Dicke - Spessore - Espesor

**17 - 30 / 100**



Certificat de conformitate CE  
N° 0071 - CPR - 14627 rev. 3



Le pourcentage de tension appliqué à la toile peut varier de 3 à 10% selon les contraintes liées à chaque projet - The percentage of tension applied to the sheet can vary from 3 to 10% depending on the constraints of each project - Die auf die Folie angebrachte Spannung kann von 3 bis 10% je nach den Projektbeschränkungen variieren - La percentuale di tensione applicata al telo può essere variabile dal 3 al 10% secondo le esigenze legate ad ogni progetto - El porcentaje de tensión aplicado a la tela puede variar entre el 3 y el 10% según las especificaciones técnicas a cada proyecto.

Les couleurs imprimées peuvent présenter un léger écart avec la réalité, notre carte d'échantillons est à votre disposition pour plus de précisions. - Printed colors may present a slight variation with the reality, our sample booklet is available for more precision. - Die gedruckten Farben können in der Realität von der Darstellung abweichen; eine Broschüre mit Muster ist für genauere Abgleiche erhältlich - I colori riportati nella presente stampa possono presentare una leggera differenza dal materiale reale, la nostra campionario è a vostra disposizione per facilitare la vostra scelta - Dado que estos colores fueron impresos puede existir una diferencia con la realidad, por eso nuestra carta con muestras está a su dispuesta para una mayor precisión.

En fonction de l'intensité de l'exposition au rayonnement solaire, de la composition de l'atmosphère de la pièce (fumée...), la teinte peut légèrement varier dans le temps. Depending on the intensity of the solar radiance exposition and the atmosphere composition (smoke...) of the room, the shade of the sheet may vary in the time. Abhängig von der Sonneneinstrahlung und der Luftzusammensetzung im Raum (Rauch...) kann sich das Erscheinungsbild der Folien zeitlich ändern. In funzione dell'intensità dell'esposizione ai raggi del sole e della composizione dell'atmosfera (fumo...) della stanza, la tinta del telo può leggermente variare col tempo. Según la intensidad de la exposición a la radiación solar, de la composición de la atmósfera de la habitación (humo...), el tinte puede variar con el tiempo.



Arch. : Tranform

Arch. : Rafael Viñoly

# Xtrem®

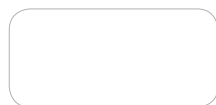

**X1010** Blanc Xmat\*\*\*<sup>(2)</sup>

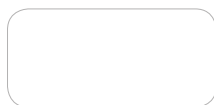

**X7010** Blanc wight\*\*<sup>(1)</sup>

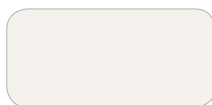

**X4015** Mercure\*\*\*<sup>(2)</sup>

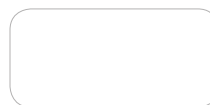

**X1060** Blanc douceur\*<sup>(1)</sup>

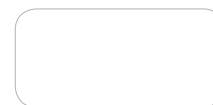

**X4030** Athena\*<sup>(1)</sup>



**X4016** Sedna\*<sup>(2)</sup>



**X4018** Plutonia\*\*\*<sup>(2)</sup>



**X4014** Calisto Translucide\*\*\*<sup>(2)</sup>



**X1055** Reverso1\*<sup>(1)</sup> (blanc/noir)



**X1056** Reverso2\*<sup>(1)</sup> (gris/blanc)



**X4060** Antares\*<sup>(1)</sup>



**X4080** Polaris\*<sup>(1)</sup>

## ACOUSTICS®

A15 - A20 - A30 : ≤ 220 cm

A40 : ≤ 200 cm.

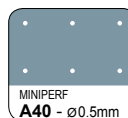
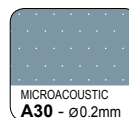
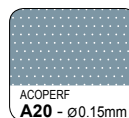
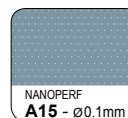

## PERFORATIONS - PERFORATIONS - PERFORATIONEN PERFORAZIONE - PERFORACIÓN

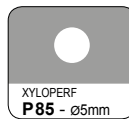
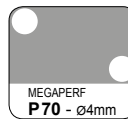
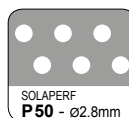
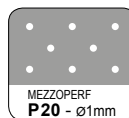
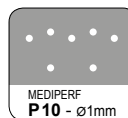

Taux de transmission et de réflexion de la lumière - Light transmission and reflexion rate  
Lichtverbreitungsgrad und Lichtreflexionsgrad - Tasso di trasmissione e riflessione della luce  
Porcentaje de transmisión y reflexión de la luz

	Transmission - Transmission - Verbreitung Trasmisione - Trasmisión		Réflexion - Reflexion - Reflexion Riflessione - Reflexión	
	Norme - Norm - Norm - Normativa - Normativa : ASTM E903 - NF EN 410			
<b>X4015</b> Mercure	52%		51%	
<b>X4030</b> Athena	48%		48%	
<b>X4016</b> Sedna	49%		51%	
<b>X4018</b> Plutonia	44%		51%	
<b>X4014</b> Calisto	42%		59%	
<b>X4080</b> Polaris	77%		21%	

Classement au feu - Fire classification - Brandverhalten -  
Classe di reazione al fuoco - Clasificación al fuego

<sup>(1)</sup> **B-s1, d0**

<sup>(2)</sup> **B-s2, d0**

Largeur des lés - Sheet width - Folienbreite - Larghezza dei teli - Ancho de tela

A noter : des soudures sont possibles dans les plafonds en fonction des dimensions et configurations de projets - Please note : seams are possible on the ceilings depending on the projects dimensions and configuration. - Bemerkung: Nähte in der Spanndecke sind je nach Abmessungen und Projektkonfiguration möglich. - NB: Sarà possibile la presenza di saldature sui controsoffitti in base alla geometria e dimensioni dei teli e alle caratteristiche dei progetti. - A tener en cuenta : las soldaduras son posibles en función de las dimensiones o configuraciones de los proyectos.

**\*235 cm**  
◀▶ 220 cm

**\*\*245 cm**  
◀▶ 225 cm

**\*\*\*256 cm**  
◀▶ 240 cm

Epaisseur - Thickness - Dicke - Spessore - Espesor

**17 - 30 / 100**

Le pourcentage de tension appliqué à la toile peut varier de 3 à 10% selon les contraintes liées à chaque projet - The percentage of tension applied to the sheet can vary from 3 to 10% depending on the constraints of each project - Die auf die Folie angebrachte Spannung kann von 3 bis 10% je nach den Projektbeschränkungen variieren - La percentuale di tensione applicata al telo può essere variabile dal 3 al 10% secondo le esigenze legate ad ogni progetto - El porcentaje de tensión aplicado a la tela puede variar entre el 3 y el 10% según las especificaciones técnicas a cada proyecto.

Les couleurs imprimées peuvent présenter un léger écart avec la réalité, notre carte d'échantillons est à votre disposition pour plus de précisions. - Printed colors may present a slight variation with the reality, our sample booklet is available for more precision. - Die gedruckten Farben können in der Realität von der Darstellung abweichen; eine Broschüre mit Muster ist für genauere Abgleiche erhältlich - I colori riportati nella presente stampa possono presentare una leggera differenza dal materiale reale, la nostra campionario è a vostra disposizione per facilitare la vostra scelta - Dado que estos colores fueron impresos puede existir una diferencia con la realidad, por eso nuestra carta con muestras está a su disposición para una mayor precisión.

En fonction de l'intensité de l'exposition au rayonnement solaire, de la composition de l'atmosphère de la pièce (fumée...), la teinte peut légèrement varier dans le temps. Depending on the intensity of the solar radiance exposition and the atmosphere composition (smoke...) of the room, the shade of the sheet may vary in the time. Abhängig von der Sonneneinstrahlung und der Luftzusammensetzung im Raum (Rauch...) kann sich das Erscheinungsbild der Folien zeitlich ändern. In funzione dell'intensità dell'esposizione ai raggi del sole e della composizione dell'atmosfera (fumo...) della stanza, la tinta del telo può leggermente variare col tempo. Según la intensidad de la exposición a la radiación solar, de la composición de la atmósfera de la habitación (humo...) el tinte puede variar con el tiempo.





# Les Effets Lumière® Light effects Die Lichteffekte



Design : Lina GENER &  
Antonio CALVO (ACS Ibiza)



Arch. : Tümer Onaran Mimarli

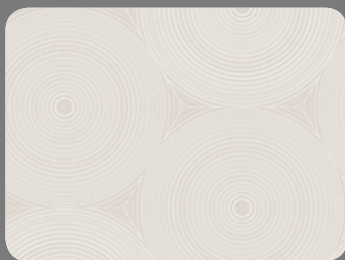

**BEL 01** Neptune\*\*\*<sup>(2)</sup>



**BEL 02** Equinox\*\*<sup>(2)</sup>



**BEL 03** Artémis\*\*<sup>(3)</sup>

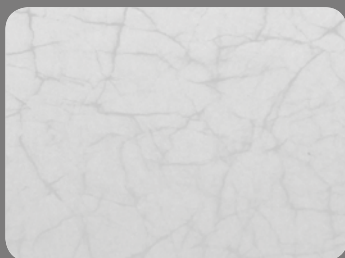

**BEL 04** Perséide\*<sup>(3)</sup>



**BEL 05** Artica\*<sup>(3)</sup>

**Effets Lumière® Artemis,**  
un motif aléatoire unique  
a unique random pattern  
ein einmaliges Zufallmotiv  
un decoro aleatorio unico  
un efecto aleatorio único

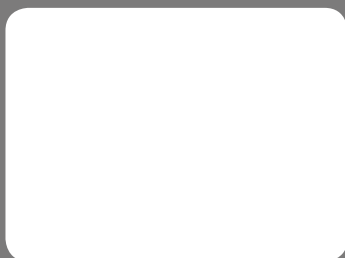

**BEL 06** Solaris\*\*\*<sup>(2)</sup>



**BEL 07** Nuages\*<sup>(3)</sup>

*Images non contractuelles - non contractual pictures - Unverbindliche Bilder - Immagine non contrattuale - Imágenes no contractuales*

Pour mieux vous rendre compte des effets visuels des finitions de la gamme des Effets Lumière®, nous vous conseillons de faire votre choix à partir d'échantillons format A4 minimum, disponibles sur simple demande.

To see the visual effects of the «Effets Lumière®» line of products, we recommend you ask for larger samples of A4 size and above. These samples are available on request.

Um den visuellen Effekt der Folien «Effets Lumière®» wählen zu können, stellen wir Ihnen A4-Muster zur Verfügung. Gerne können wir Ihnen die gewünschten Muster auf Anfrage zukommen lassen.

Per rendervi conto al meglio degli effetti visuali delle finiture della gamma degli «Effets Lumière®», vi consigliamo di fare la vostra scelta a partire di campioni formato A4 minimo, disponibili su semplice richiesta.

Les recomendamos basarse en nuestro formato A4 para poder visualizar mejor y validar los efectos de los acabados «Effets Lumière®», disponibles bajo petición.

## ACOUSTICS®

A15 - A20 - A30 : ≤ 220 cm

A40 : ≤ 200 cm.

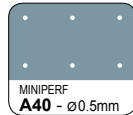
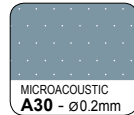
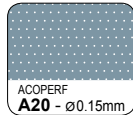
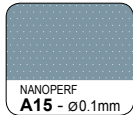

## PERFORATIONS - PERFORATIONS - PERFORATIONEN PERFORAZIONE - PERFORACIÓN

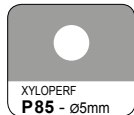
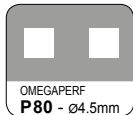
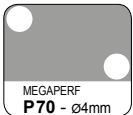
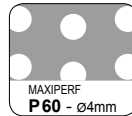
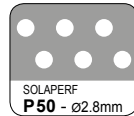
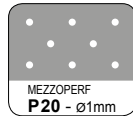
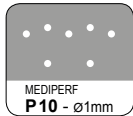

Taux de transmission et de réflexion de la lumière - Light transmission and reflection rate  
Lichtverbreitungsgrad und Lichtreflexionsgrad - Tasso di trasmissione e riflessione della luce - Porcentaje de transmisión y reflexión de la luz

	Transmission - Transmission Verbreitung - Trasmissione Transmisión	Réflexion - Reflexion Reflexion - Riflessione - Reflexión
<b>BEL 01</b> Neptune	64.5%	38%
<b>BEL 02</b> Equinox	50%	50%
<b>BEL 03</b> Artemis	88%	9%
<b>BEL 04</b> Perséide	92%	9%
<b>BEL 05</b> Artica	88%	9%
<b>BEL 06</b> Solaris	48%	51%
<b>BEL 07</b> Nuages	6%	30%

Norme - Norm - Norm - Normativa - Normativa : ASTM E903 - NF EN 410

BEL 01 - BEL 02  
BEL 06

BEL 03 - BEL 04  
BEL 05 - BEL 07

Classement au feu - Fire classification - Brandverhalten - Classe di reazione al fuoco - Clasificación al fuego

<sup>(2)</sup>**B-s2, d0**

<sup>(3)</sup>**B-s3, d0**

Largeur des lés - Sheet width - Folienbreite - Larghezza dei teli - Ancho de tela

A noter : des soudures sont possibles dans les plafonds en fonction des dimensions et configurations de projets - Please note : seams are possible on the ceilings depending on the projects dimensions and configuration. - Bemerkung: Nähte in der Spanndecke sind je nach Abmessungen und Projektkonfiguration möglich. - NB: Sarà possibile la presenza di saldature sui controsoffitti in base alla geometria e dimensioni dei teli e alle caratteristiche dei progetti. - A tener en cuenta : las soldaduras son posibles en función de las dimensiones o configuraciones de los proyectos.

**\*145 cm**  
◄► 135 cm

**\*\*162 cm**  
◄► 150 cm

**\*\*\*214 cm**  
◄► 200 cm

Epaisseur - Thickness - Dicke - Spessore - Espesor

**17 - 30 / 100**



Certificat de colorimètrie CE  
N° 0071 - CPR - 23811 rev.1

EMISSIOMS DANS L'INTERIEUR



◄► Le pourcentage de tension appliqué à la toile peut varier de 3 à 10% selon les contraintes liées à chaque projet - The percentage of tension applied to the sheet can vary from 3 to 10% depending on the constraints of each project - Die auf die Folie angebrachte Spannung kann von 3 bis 10% je nach den Projektbeschränkungen variieren - La percentuale di tensione applicata al telo può essere variabile dal 3 al 10% secondo le esigenze legate ad ogni progetto - El porcentaje de tensión aplicado a la tela puede variar entre el 3 y el 10% según las especificaciones técnicas a cada proyecto.

Les couleurs imprimées peuvent présenter un léger écart avec la réalité, notre carte d'échantillons est à votre disposition pour plus de précisions. - Printed colors may present a slight variation with the reality, our sample booklet is available for more precision. - Die gedruckten Farben können in der Realität von der Darstellung abweichen; eine Broschüre mit Muster ist für genauere Abgleiche erhältlich - I colori riportati nella presente stampa possono presentare una leggera differenza dal materiale reale, la nostra campionario è a vostra disposizione per facilitare la vostra scelta - Dado que estos colores fueron impresos puede existir una diferencia con la realidad, por eso nuestra carta con muestras está a su disposición para una mayor precisión.

En fonction de l'intensité de l'exposition au rayonnement solaire, de la composition de l'atmosphère de la pièce (fumée...), la teinte peut légèrement varier dans le temps. Depending on the intensity of the solar radiance exposition and the atmosphere composition (smoke...) of the room, the shade of the sheet may vary in the time. Abhängig von der Sonneneinstrahlung und der Luftzusammensetzung im Raum (Rauch...) kann sich das Erscheinungsbild der Folien zeitlich ändern. In funzione dell'intensità dell'esposizione ai raggi del sole e della composizione dell'atmosfera (fumo...) della stanza, la tinta del telo può leggermente variare col tempo. Según la intensidad de la exposición a la radiación solar, de la composición de la atmósfera de la habitación (humo...) el tinte puede variar con el tiempo.

# Barrisol Les Recyclés®

## The recycled

## Die Recyclen

50% pre-consumer



Réalisation : Kordekor



Arch. : FRAP

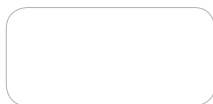

**R02** Blanc Neige



**R01** Beige Sable



**R05** Rose Fleur



**R06** Vert Nature



**R07** Bleu Ciel



**R03** Gris Perle



**R04** Noir Crepuscule

### ACOUSTICS®

A15 - A20 - A30 : ≤ 220 cm

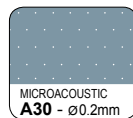
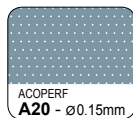
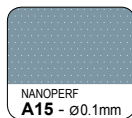

A40 : ≤ 200 cm.



Taux de réflexion de la lumière - Light reflexion rate

Lichtreflexionsgrad - Tasso di riflessione della luce - Porcentaje de reflexión de luz

**R02** Blanc

90%

Norme - Norm - Norm - Normativa - Normativa : ASTM E903 - NF EN 410

### PERFORATIONS - PERFORATIONS - PERFORATIONEN - PERFORAZIONE - PERFORACIÓN

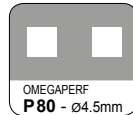
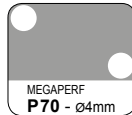
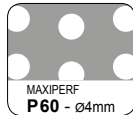
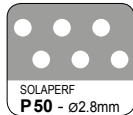
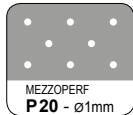
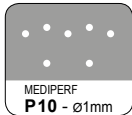

Classement au feu - Fire classification - Brandverhalten - Classe di reazione al fuoco - Clasificación al fuego

**B-s2, d0**

Largeur des lés - Sheet width - Folienbreite - Larghezza dei teli - Ancho de tela

A noter : des soudures sont possibles dans les plafonds en fonction des dimensions et configurations de projets - Please note : seams are possible on the ceilings depending on the projects dimensions and configuration. - Bemerkung: Nähte in der Spanndecke sind je nach Abmessungen und Projektanforderungen möglich. - NB: Sarà possibile la presenza di saldature sui controsoffitti in base alla geometria e dimensioni dei teli e alle caratteristiche dei progetti. - A tener en cuenta : las soldaduras son posibles en función de las dimensiones o configuraciones de los proyectos.

**214 cm**  
**200 cm**

Epaisseur - Thickness - Dicke - Spessore - Espesor

**17 / 100**



Certificat de conformité CE  
 N° 0071 - CPR - 14627 rev.3



Des légères variations de teinte, dues au process de recyclage peuvent apparaître dans la gamme des Recyclés®. - Due to the recycling process slight colour variations may appear in the "Recyclés®" line of production. - Aufgrund des Recyclingprozesses können in der Produktionslinie «Recyclés®» leichte Farbabweichungen auftreten. - Delle leggere variazioni di tinta, dovute al processo di riqualificazione dei teli, possono apparire nella gamma dei teli Recyclés® - Ligeras variaciones de color, debidas al proceso de reciclaje pueden aparecer en la gama de los reciclados / Recyclés®

Le pourcentage de tension appliqué à la toile peut varier de 3 à 10% selon les contraintes liées à chaque projet - The percentage of tension applied to the sheet can vary from 3 to 10% depending on the constraints of each project - Die auf die Folie angebrachte Spannung kann von 3 bis 10% je nach den Projektbeschränkungen variieren - La percentuale di tensione applicata al telo può essere variabile dal 3 al 10% secondo le esigenze legate ad ogni progetto - El porcentaje de tensión aplicado a la tela puede variar entre el 3 y el 10% según las especificaciones técnicas a cada proyecto.

Les couleurs imprimées peuvent présenter un léger écart avec la réalité, notre carte d'échantillons est à votre disposition pour plus de précisions. - Printed colors may present a slight variation with the reality, our sample booklet is available for more precision. - Die gedruckten Farben können in der Realität von der Darstellung abweichen; eine Broschüre mit Muster ist für genauere Abgleiche erhältlich. - I colori riportati nella presente stampa possono presentare una leggera differenza dal materiale reale, la nostra campionatura è a vostra disposizione per facilitare la vostra scelta. - Dado que estos colores fueron impresos puede existir una diferencia con la realidad, por eso nuestra carta con muestras está a su disposición para una mayor precisión.

En fonction de l'intensité de l'exposition au rayonnement solaire, de la composition de l'atmosphère de la pièce (fumée...), la teinte peut légèrement varier dans le temps. - Depending on the intensity of the solar radiation exposure and the atmosphere composition (smoke...) of the room, the shade of the sheet may vary in the time. - Abhängig von der Sonneneinstrahlung und der Luftzusammensetzung im Raum (Rauch...) kann sich das Erscheinungsbild der Folien zeitlich ändern. - In funzione dell'intensità dell'esposizione ai raggi del sole e della composizione dell'atmosfera (fumo...) della stanza, la tinta del telo può leggermente variare col tempo. - Según la intensidad de la exposición a la radiación solar, de la composición de la atmósfera de la habitación (humo...) el tinte puede variar con el tiempo.



## Ecologie - Ecology - Ökologie - Ecologia - Ecología



	Barrisol®	autres types de plafonds - other types of ceilings andere Decken - altri tipi di soffitti - otros tipos de techos
Poids - weight - Gewicht - peso - peso	<b>0.5kg/m<sup>2</sup></b>	12kg/m <sup>2</sup>
<i>pour - for - für - para - para</i> <b>10 000 m<sup>2</sup></b>	<b>5 t</b>	120 t

**115 tonnes de matière première en moins**  
**115 tons less of raw material - 115 Tonnen weniger Rohstoffe**  
**115 tonnellate di materie prime in meno - menos 115 toneladas de materias primas**

### Les toiles Barrisol® sont recyclables à 100%.

Barrisol® accorde depuis longtemps une grande importance au respect de l'environnement.

De plus, l'ensemble des matériaux utilisés pour la production est recyclable ou fait de matières recyclées (emballages, conditionnements...).

**La nouvelle gamme de toiles «Les recyclés®» va encore plus loin puisqu'en plus d'être recyclables à 100% comme toutes les autres toiles Barrisol®, elles sont fabriquées à partir de matières Barrisol® recyclées.**

### Barrisol® membranes are 100% recyclables.

Since the beginning Barrisol® is claiming his ecological commitment by respecting the environment.

Furthermore, the raw material used for production are recyclable or made with recycled materials (packaging, shipping packing...)

**On top of these recyclable sheets Barrisol® get further by offering a product range named «Les recyclés®» in which all the sheets are done with Barrisol® recycled matters.**

### Die Barrisol® Folien sind 100% wiederverwertbar.

Wir messen dem Umweltschutz schon seit langer Zeit eine große Bedeutung bei.

Daher verwenden wir für die Herstellung der BARRISOL®-Spanndecken ausschließlich Materialien, die entweder wiederverwertbar sind oder bereits wieder verwertet wurden.

**BARRISOL® bietet nun eine neue Serie von Spannfolien an: die Ökologischen - «Les recyclés®». Diese Folien werden ausschließlich aus wiederverwerteten Barrisol® Materialien hergestellt.**

### I teli Barrisol® sono riciclabili al 100%.

Da sempre Barrisol® s'impegna nell'ambito dell'ecologia contribuendo al rispetto dell'ambiente. In più, l'insieme dei materiali utilizzati per la produzione è riciclabile o composto da materie riciclabili (imballaggio, condizionamento...)

**Oltre a produrre dei teli riciclabili, Barrisol® s'impegna ancora proponendo una nuova gamma «Les recyclés®» i cui teli sono fabricati di materiale Barrisol® riciclabile.**

### Las telas Barrisol® son reciclables al 100%

Desde siempre Barrisol® asume su consciencia ecológica y contribuye al respecto del medio ambiente. Todos los materiales usados en producción son reciclables o hechos de materias recicladas (embalajes, acondicionamiento...).

**Además de producir telas reciclables, Barrisol® empeña su responsabilidad ecológica lanzando una nueva gama de telas «Les recyclés®» compuesta de materia Barrisol® reciclada.**

# Barrisol Biosourcée®

## Biosource

### Die Biobasierte



Design : Zegal Viet Nam Jsc



Arch. : Kris yao Architect

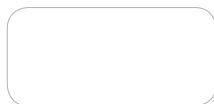

**BOS 01 Arctic\*\***

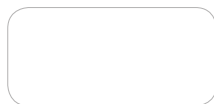

**BOT 05 Atlas\*\***

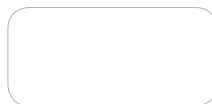

**BOL 01 Blanc Edelweiss\***

#### ACOUSTICS®

A15 - A20 - A30 : ≤ 220 cm

A40 : ≤ 200 cm.

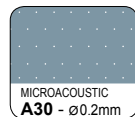
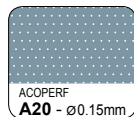
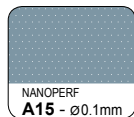

#### PERFORATIONS - PERFORATIONS - PERFORATIONEN - PERFORAZIONE - PERFORACIÓN

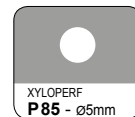
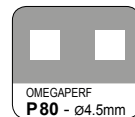
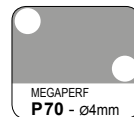
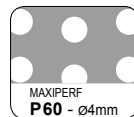
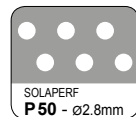
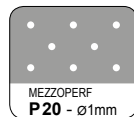
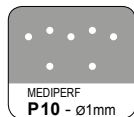

Classement au feu - Fire classification - Brandverhalten - Classe di reazione al fuoco - Clasificación al fuego

**B-s1, d0**

Largeur des lés - Sheet width - Folienbreite - Larghezza dei teli - Ancho de tela

A noter : des soudures sont possibles dans les plafonds en fonction des dimensions et configurations de projets - Please note : seams are possible on the ceilings depending on the projects dimensions and configuration. - Bemerkung: Nähte in der Spanndecke sind je nach Abmessungen und Projektkonfiguration möglich. - NB: Sarà possibile la presenza di saldature sui controsoffitti in base alla geometria e dimensioni dei teli e alle caratteristiche dei progetti. - A tener en cuenta : las soldaduras son posibles en función de las dimensiones o configuraciones de los proyectos.

**\*162 cm**  
 ◀▶ 150 cm

**\*\*236 cm**  
 ▶◀ 220 cm

Epaisseur - Thickness - Dicke - Spessore - Espesor

**17-18 / 100**



Certificat de conformitate CE  
 N° 0071 - CPR - 14627 rev.3



Des légères variations de teinte, dues au process de recyclage peuvent apparaître dans la gamme des «Biosourcées®» - Due to the recycling process slight colour variations may appear in the «Biosourcées®» line of production. - Aufgrund des Recyclingprozesses können in der Produktionslinie «Biosourcées®» leichte Farbabweichungen auftreten. - Delle leggere variazioni di tinta, dovute al processo di riqualificazione dei teli, possono apparire nella gamma dei teli «Biosourcées®» - Ligeras variaciones de color, debidas al proceso de reciclaje pueden aparecer en la gama de los «Biosourcées®».

▶◀ Le pourcentage de tension appliqué à la toile peut varier de 3 à 10% selon les contraintes liées à chaque projet - The percentage of tension applied to the sheet can vary from 3 to 10% depending on the constraints of each project - Die auf die Folie angebrachte Spannung kann von 3 bis 10% je nach den Projektbeschränkungen variieren - La percentuale di tensione applicata al telo può essere variabile dal 3 al 10% secondo le esigenze legate ad ogni progetto - El porcentaje de tensión aplicado a la tela puede variar entre el 3 y el 10% según las especificaciones técnicas a cada proyecto.

Les couleurs imprimées peuvent présenter un léger écart avec la réalité, notre carte d'échantillons est à votre disposition pour plus de précisions. - Printed colors may present a slight variation with the reality, our sample booklet is available for more precision. - Die gedruckten Farben können in der Realität von der Darstellung abweichen; eine Broschüre mit Muster ist für genauere Abgleiche erhältlich. - I colori riportati nella presente stampa possono presentare una leggera differenza dal materiale reale, la nostra campionario è a vostra disposizione per facilitare la vostra scelta. - Dado que estos colores fueron impresos puede existir una diferencia con la realidad, por eso nuestra carta con muestras está a su dispuesta para una mayor precisión.

En fonction de l'intensité de l'exposition au rayonnement solaire, de la composition de l'atmosphère de la pièce (fumée...), la teinte peut légèrement varier dans le temps. Depending on the intensity of the solar radiance exposition and the atmosphere composition (smoke...) of the room, the shade of the sheet may vary in the time. Abhängig von der Sonneneinstrahlung und der Luftzusammensetzung im Raum (Rauch...) kann sich das Erscheinungsbild der Folien zeitlich ändern. In funzione dell'intensità dell'esposizione ai raggi del sole e della composizione dell'atmosfera (fumo...) della stanza, la tinta del telo può leggermente variare col tempo. Según la intensidad de la exposición a la radiación solar, de la composición de la atmósfera de la habitación (humo...) el tinte puede variar con el tiempo.

## Ecologie - Ecology - Ökologie - Ecologia - Ecología



	<b>Barrisol®</b>	autres types de plafonds - other types of ceilings andere Decken - altri tipi de soffitti - otros tipos de techos
Poids - weight - Gewicht - peso - peso	<b>0.5kg/m<sup>2</sup></b>	12kg/m <sup>2</sup>
<i>pour - for - für - para - para</i> <b>10 000 m<sup>2</sup></b>	<b>5 t</b>	120 t

**115 tonnes de matière première en moins**  
**115 tons less of raw material - 115 Tonnen weniger Rohstoffe**  
**115 tonnellate di materie prime in meno - menos 115 toneladas de materias primas**



### **Les toiles Barrisol® sont recyclables à 100%.**

Barrisol® accorde depuis longtemps une grande importance au respect de l'environnement.

De plus, l'ensemble des matériaux utilisés pour la production est recyclable ou fait de matières recyclées (emballages, conditionnements...).

**La nouvelle gamme de toiles «Barrisol® Biosourcée» contient un agent plastifiant d'origine végétale (≈ 30% pour la version satinée et jusqu'à 10% pour la version translucide).**

### **Barrisol® membranes are 100% recyclables.**

Since the beginning Barrisol® is claiming his ecological commitment by respecting the environment.

Furthermore, the raw material used for production are recyclable or made with recycled materials (packaging, shipping packing...)

**The new range of sheets «Barrisol Biosourcée®» contains a plasticizing agent of vegetable origin (≈ 30% for mat version and up to 10% for the translucent version).**

### **Die Barrisol® Folien sind 100% wiederverwertbar.**

Wir messen dem Umweltschutz schon seit langer Zeit eine große Bedeutung bei.

Daher verwenden wir für die Herstellung der Barrisol®-Spanndecken ausschließlich Materialien, die entweder wiederverwertbar sind oder bereits wieder verwertet wurden.

**Die neue Spannfolie «Barrisol® Biosourcée®» enthält einen Weichmacher pflanzlichen Ursprungs (≈30% für die Matte-Version und bis zu 10% für die transluzente Version).**

### **I teli Barrisol® sono riciclabili al 100%.**

Da sempre Barrisol® s'impegna nell'ambito dell'ecologia contribuendo al rispetto dell'ambiente. In più, l'insieme dei materiali utilizzati per la produzione è riciclabile o composto da materie riciclabili (imballaggio, condizionamento...)

**La nuova gamma di fogli «Barrisol Biosourcée®» contiene un agente plastificante di origine vegetale (≈ 30% per la versione tampone e fino al 10% per la versione traslucida).**

### **Las telas Barrisol® son reciclables al 100%**

Desde siempre Barrisol® asume su consciencia ecológica y contribuye al respecto del medio ambiente. Todos los materiales usados en producción son reciclables o hechos de materias recicladas (embalajes, acondicionamiento...).

**La nueva gama de telas «Barrisol Biosourcées®» contiene un agente plastificante de origen vegetal (≈ 30% para la versión mate y hasta 10% para la versión translúcida).**



# Les Daims Ambiance® Suede Das Ambiente Wildleder



Arch. : Alfons Tost Decoracion



Arch. : Aedas Architects



**05085** Bordeaux ambiance

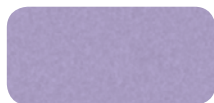

**05088** Lilas cocooning



**05073** Bleu marine nirvana

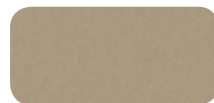

**05055** Beige foncé évasion



**05056** Vert pastel détente



**05083** Rouge passion



**05116** Gris intimité



**05074** Bleu marine rêverie



**05024** Beige élégance



**05064** Vert style



**05084** Rouille confort



**05090** Bleu tendance



**05041** Noir design



**05054** Or standing



**05062** Vert relaxation



**05086** Rose charme



**05071** Bleu ciel bien être



**05034** Brun décoration

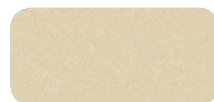

**05154** Coquille douceur



**05021** Jaune douillet

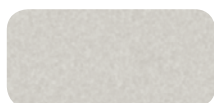

**05115** Gris raffinement



**05072** Bleu fashion



**05032** Brun sérénité

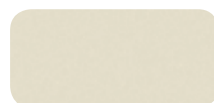

**05114** Lin harmonie



**05010** Blanc Eden

Pour mieux vous rendre compte des effets visuels des finitions de la gamme des Daims Ambiance®, nous vous conseillons de faire votre choix à partir d'échantillons format A4 minimum, disponibles sur simple demande.

To see the visual effects of the «Daims Ambiance®» line of products, we recommend you ask for larger samples of A4 size and above. These samples are available on request.

Um den visuellen Effekt der Folien «Daims Ambiance®» wählen zu können, stellen wir Ihnen A4-Muster zur Verfügung. Gerne können wir Ihnen die gewünschten Muster auf Anfrage zukommen lassen.

Per rendervi conto al meglio degli effetti visuali delle finiture della gamma degli «Daims Ambiance®», vi consigliamo di fare la vostra scelta a partire di campioni formato A4 minimo, disponibili su semplice richiesta.

Les recomendamos basarse en nuestro formato A4 para poder visualizar mejor y validar los efectos de los acabados suedes cepillado (Daims Ambiance®), disponibles bajo petición.

## ACOUSTICS®

A15 - A20 - A30 : ≤ 220 cm

A40 : ≤ 200 cm.

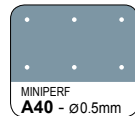
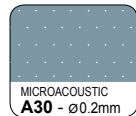
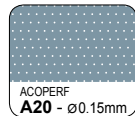
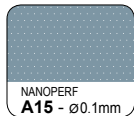

## PERFORATIONS - PERFORATIONS - PERFORATIONEN - PERFORAZIONE - PERFORACIÓN

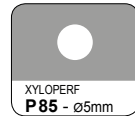
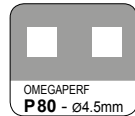
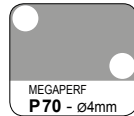
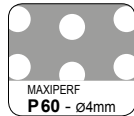
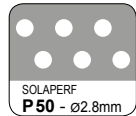
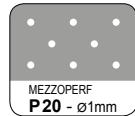
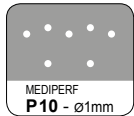

Classement au feu - Fire classification - Brandverhalten - Classe di reazione al fuoco - Clasificación al fuego

**B-s3, d0**

Largueur des lés - Sheet width - Folienbreite - Larghezza dei teli - Ancho de tela

A noter : des soudures sont possibles dans les plafonds en fonction des dimensions et configurations de projets - Please note : seams are possible on the ceilings depending on the projects dimensions and configuration. - Bemerkung: Nähte in der Spanndecke sind je nach Abmessungen und Projektkonfiguration möglich. - NB: Sarà possibile la presenza di saldature sui controsoffitti in base alla geometria e dimensioni dei teli e alle caratteristiche dei progetti. - A tener en cuenta : las soldaduras son posibles en función de las dimensiones o configuraciones de los proyectos.

**150 cm**  
 **140 cm**

Epaisseur - Thickness - Dicke - Spessore - Espesor

**29 - 30 / 100**



 Le pourcentage de tension appliqué à la toile peut varier de 3 à 10% selon les contraintes liées à chaque projet - The percentage of tension applied to the sheet can vary from 3 to 10% depending on the constraints of each project - Die auf die Folie angebrachte Spannung kann von 3 bis 10% je nach den Projektbeschränkungen variieren - La percentuale di tensione applicata al telo può essere variabile dal 3 al 10% secondo le esigenze legate ad ogni progetto - El porcentaje de tensión aplicado a la tela puede variar entre el 3 y el 10% según las especificaciones técnicas a cada proyecto.

Les couleurs imprimées peuvent présenter un léger écart avec la réalité, notre carte d'échantillons est à votre disposition pour plus de précisions. - Printed colors may present a slight variation with the reality, our sample booklet is available for more precision. - Die gedruckten Farben können in der Realität von der Darstellung abweichen; eine Broschüre mit Muster ist für genauere Abgleiche erhältlich - I colori riportati nella presente stampa possono presentare una leggera differenza dal materiale reale, la nostra campionatura è a vostra disposizione per facilitare la vostra scelta. - Dado que estos colores fueron impresos puede existir una diferencia con la realidad, por eso nuestra carta con muestras está a su disposición para una mayor precisión.

En fonction de l'intensité de l'exposition au rayonnement solaire, de la composition de l'atmosphère de la pièce (fumée...), la teinte peut légèrement varier dans le temps. Depending on the intensity of the solar radiance exposition and the atmosphere composition (smoke...) of the room, the shade of the sheet may vary in the time. Abhängig von der Sonneneinstrahlung und der Luftzusammensetzung im Raum (Rauch...) kann sich das Erscheinungsbild der Folien zeitlich ändern. In funzione dell'intensità dell'esposizione ai raggi del sole e della composizione dell'atmosfera (fumo...) della stanza, la tinta del telo può leggermente variare col tempo. Según la intensidad de la exposición a la radiación solar, de la composición de la atmósfera de la habitación (humo...), el tinte puede variar con el tiempo.

# Creadesign®



Réalisation : Barrisol®



Arch. : Edoardo Corvaia

## 1\_ Choisissez un motif - Select a pattern - Wählen Sie eine Muster aus Scegliete un decoro - Elija su dibujo



**BCA** Zebra

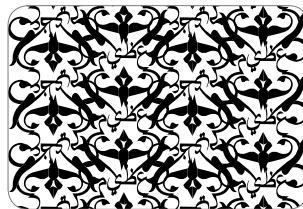

**BCO** Orient

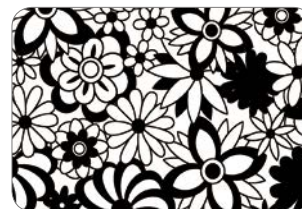

**BCD** Floral



**BCF** Spirale

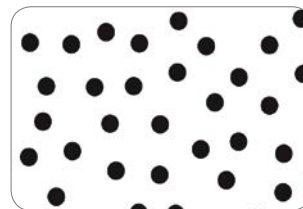

**BCG** Dot



**BCH** Zen



**BCJ** Zèbre

*Créez votre propre motif\**  
*Create your own pattern\**  
*Schaffen Sie ihr eigenes Motiv\**  
*Create il vostra proprio motivo\**  
*Crie o seu motivo \**

*Images non contractuelles - non contractual pictures - Unverbindliche Bilder - Immagine non contrattuale - Imágenes no contractuales*



## 2 Choisissez une couleur de flockage - Select a colour of flocking - Wählen Sie eine Farbe aus - Scegliete il colore dell'effetto daino - Elija el color del flocado\*



## 3 Choisissez une finition de toile - Select a sheet finish - Wählen Sie eine Folie aus - Scegliete una finitura di telo - E lija el acabado de la tela

Les rêves satinés®

Les mats traditions®

Les translucides®

Les recyclés®

### ACOUSTICS®

A15 - A20 - A30 : ≤ 220 cm

A40 : ≤ 200 cm.

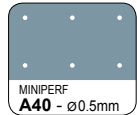
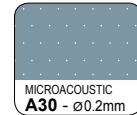
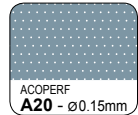
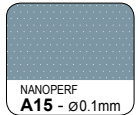

Pour mieux vous rendre compte des effets visuels des finitions de la gamme Creadesign®, nous vous conseillons de faire votre choix à partir d'échantillons format A4 minimum, disponibles sur simple demande. To see the visual effects of the Creadesign® line of products, we recommend you ask for larger samples of A4 size and above. These samples are available on request.

Um den visuellen Effekt der Folien Creadesign® wählen zu können, stellen wir Ihnen A4-Muster zur Verfügung. Gerne können wir Ihnen die gewünschten Muster auf Anfrage zukommen lassen.

Per rendervi conto al meglio degli effetti visuali delle finiture della gamma degli Creadesign®, vi consigliamo di fare la vostra scelta a partire di campioni formato A4 minimo, disponibili su semplice richiesta.

Les recomendamos basarse en nuestro formato A4 para poder visualizar mejor y validar los efectos de los acabados Creadesign®, disponibles bajo petición.

Classement au feu - Fire classification - Brandverhalten - Classe di reazione al fuoco - Clasificación al fuego

**B-s2, d0**

Largeur des lés - Sheet width - Folienbreite - Larghezza dei teli - Ancho de tela

A noter : des soudures sont possibles dans les plafonds en fonction des dimensions et configurations de projets - Please note : seams are possible on the ceilings depending on the projects dimensions and configuration. - Bemerkung: Nähte in der Spanndecke sind je nach Abmessungen und Projektkonfiguration möglich. - NB: Sarà possibile la presenza di saldature sui controsoffitti in base alla geometria e dimensioni dei teli e alle caratteristiche dei progetti. - A tener en cuenta : las soldaduras son posibles en función de las dimensiones o configuraciones de los proyectos.

**150 cm**  
↔ 140 cm

Epaisseur - Thickness - Dicke - Spessore - Espesor

**70 / 100**

\* Acceptation et validation par notre bureau d'études - quantité minium de 500 m<sup>2</sup> - Acceptance and validation by our technical office required - quantity minimum of 500 m<sup>2</sup> - Freigabe und Bestätigung durch unser technisches Entwicklungsbüro - Mindestemenge 500 m<sup>2</sup> - Accettazione e convalida dal nostro ufficio tecnico - quantità minima di 500 mq. - Aceptación y validación por nuestra sociedad requerida - cantidad minima de 500 m<sup>2</sup>.



Certificat de conformitate CE  
N° 0071 - CPR - 17775 rev. 3



Le pourcentage de tension appliqué à la toile peut varier de 3 à 10% selon les contraintes liées à chaque projet - The percentage of tension applied to the sheet can vary from 3 to 10% depending on the constraints of each project - Die auf die Folie angebrachte Spannung kann von 3 bis 10% je nach den Projektbeschränkungen variieren - La percentuale di tensione applicata al telo può essere variabile dal 3 al 10% secondo le esigenze legate ad ogni progetto - El porcentaje de tensión aplicado a la tela puede variar entre el 3 y el 10% según las especificaciones técnicas a cada proyecto.

Les couleurs imprimées peuvent présenter un léger écart avec la réalité, notre carte d'échantillons est à votre disposition pour plus de précisions. - Printed colors may present a slight variation with the reality, our sample booklet is available for more precision. - Die gedruckten Farben können in der Realität von der Darstellung abweichen, eine Broschüre mit Muster ist für genauere Abgleiche erhältlich - I colori riportati nella presente stampa possono presentare una leggera differenza dal materiale reale, la nostra campionario è a vostra disposizione per facilitare la vostra scelta - Dado que estos colores fueron impresos puede existir una diferencia con la realidad, por eso nuestra carta con muestras está a su disposición para una mayor precisión.

En fonction de l'intensité de l'exposition au rayonnement solaire, de la composition de l'atmosphère de la pièce (fumée...), la teinte peut légèrement varier dans le temps. Depending on the intensity of the solar radiance exposition and the atmosphère composition (smoke...) of the room, the shade of the sheet may vary in the time. Abhängig von der Sonneneinstrahlung und der Luftzusammensetzung im Raum (Rauch...) kann sich das Erscheinungsbild der Folien zeitlich ändern. In funzione dell'intensità dell'esposizione ai raggi del sole e della composizione dell'atmosfera (fumo...) della stanza, la tinta del telo può leggermente variare col tempo. Según la intensidad de la exposición a la radiación solar, de la composición de la atmósfera de la habitación (humo...), el tinte puede variar con el tiempo.

# Mirror®



Design : Stächelín GmbH

Arch. : MCM Architecture

Existe en 5 autres finitions - Available in 5 other finishes - Erhältlich in 5 verschiedenen Ausführungen - Disponibile in 5 altre finizioni - Disponibile en 5 acabados



## BHS 1

MIRROR® Argent  
MIRROR® Silber  
MIRROR® Silber  
MIRROR® Argento  
MIRROR® Plata



## BHMG 1

MIRROR® Or  
MIRROR® Gold  
MIRROR® Gold  
MIRROR® Oro  
MIRROR® Oro



## BHMC 1

MIRROR® Cuivre moiré  
MIRROR® Copper Moiré  
MIRROR® Kupfer Moiré  
MIRROR® Rame Moiré  
MIRROR® Cobre Moiré



## BHMN 1

MIRROR® Noir  
MIRROR® Black  
MIRROR® Schwarz  
MIRROR® Nero  
MIRROR® Negro



## BHME 1

MIRROR® Etain moiré  
MIRROR® Tin Moiré  
MIRROR® Zinn Moiré  
MIRROR® Stagno Moiré  
MIRROR® Estaño Moiré



## BHMC 2

MIRROR® Cuivre  
MIRROR® Copper  
MIRROR® Kupfer  
MIRROR® Rame  
MIRROR® Cobre



Arch. : Estudio Acedanario

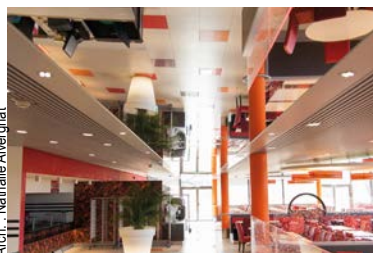

Arch. : Nathalie Avergnet



Arch. : Dickson Interior Design

Nous recommandons d'utiliser cette finition essentiellement au plafond. Si vous souhaitez l'utiliser en mural, veuillez nous consulter au préalable. - This finish is designed for ceiling application essentially. Before considering any wall application, please consult us. - Wir empfehlen, diese Ausführung zur Deckengestaltung zu verwenden. Falls Sie diese Ausführung an Wänden einsetzen möchten, bitte kontaktieren Sie uns vorab. - Raccomandiamo di utilizzare questa finitura essenzialmente per soffitto. Se volete usarla a parete, vi preghiamo di contattarci prealabilmente. - Recomendamos la utilización de este acabado para de para techo unicamente. Si desea aplicarlo en murales, conviene consultarnos previamente

# Imprimez vos images - Print your own images Bedrucken Sie Ihre eigenen Bilder - Stampare le Vs immagini - Imprimir sus imágenes

Toile imprimée - Printed sheet  
Bedrúckte Folie - Telo stampato  
Tela impresa

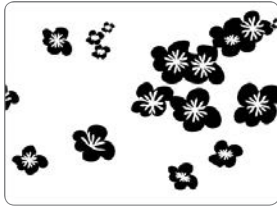

**Éléments à fournir - Elements to provide for printing - Benötigte Daten für Ihre Bestellung - Elementi da fornire**  
**Elementos que proporcionar**  
Positionnement de l'image - Image position  
Bildpositionierung - Posizionamento dell'immagine  
Localización de la imagen

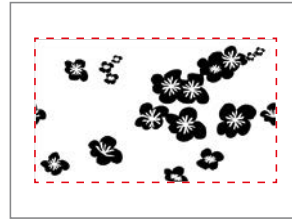
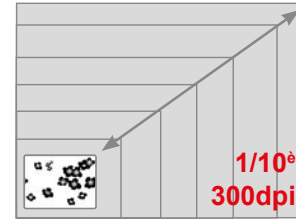

Image à fournir - Image to provide for printing  
Bild / Foto - Elementi da fornire - Imagen



Couleurs - Colours  
Farben - Colori - Colores  
**CMJN**

Fichier - File  
Datey - Archivio - Archivio  
**TIFF, EPS, JPG**

## ACOUSTICS®

A15 - A20 - A30 : ≤ 220 cm

A40 : ≤ 200 cm.

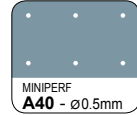
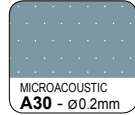
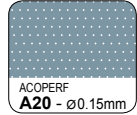
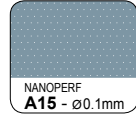

## PERFORATIONS - PERFORATIONS - PERFORATIONEN PERFORAZIONE - PERFORACIÓN

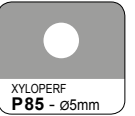
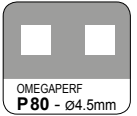
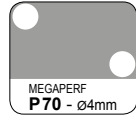
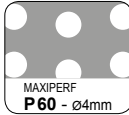
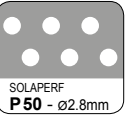
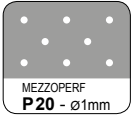
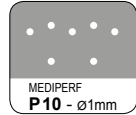

Etude de faisabilité et validation du motif par notre bureau d'études obligatoire, merci de nous contacter pour toute information complémentaire  
Acceptance and validation by our technical office required, please contact us for more information  
Freigabe und Bestätigung durch unser technisches Entwicklungsbüro, für weitere Fragen stehen wir Ihnen gerne zur Verfügung  
Studio di fattibilità e convalida dell'immagine dal nostro ufficio tecnico obbligatoria, vi preghiamo di contattarci per ogni richiesta supplementare  
Estudio de viabilidad y validación de la image por nuestra empresa es obligatorio, gracias por contactarnos para cualquier información complementaria

Pour mieux vous rendre compte des effets visuels des finitions de la gamme Mirror®, nous vous conseillons de faire votre choix à partir d'échantillons format A4 minimum, disponibles sur simple demande.  
To see the visual effects of the Mirror® line of products, we recommend you ask for larger samples of A4 size and above. These samples are available on request.  
Um den visuellen Effekt der Folien Mirror® wählen zu können, stellen wir Ihnen A4-Muster zur Verfügung. Gerne können wir Ihnen die gewünschten Muster auf Anfrage zukommen lassen.  
Per rendervi conto al meglio degli effetti visuali delle finiture della gamma degli Mirror®, vi consigliamo di fare la vostra scelta a partire di campioni formato A4 minimo, disponibili su semplice richiesta.  
Les recomendamos basarse en nuestro formato A4 para poder visualizar mejor y validar los efectos de los acabados Mirror®, disponibles bajo petición.

Classement au feu - Fire classification - Brandverhalten  
Classe di reazione al fuoco - Clasificación al fuego

**B-s2, d0**

Largeur d'impression sans soudure - printed width without seem - Druckgröße übergangslos  
Misura della stampa senza saldatura - Ancho de impresión sin soldadura

**130 cm**  
➡ 140 cm

Délais d'impression - printing lead-time - Druckbearbeitungsdauer - Tempi di stampa  
Plazos de impresión

**\*\*\*3 semaines**  
weeks - Wochen - semanas - semanas



\*\*\* Dès validation complète du dossier - From file acceptance and validation - Ab kompletter Bestätigung der Daten - A partire della validazione completa del disegno - A partir de validación completa del techo.

➡ Le pourcentage de tension appliqué à la toile peut varier de 3 à 10% selon les contraintes liées à chaque projet - The percentage of tension applied to the sheet can vary from 3 to 10% depending on the constraints of each project - Die auf die Folie angebrachte Spannung kann von 3 bis 10% je nach den Projektbeschränkungen variieren - La percentuale di tensione applicata al telo può essere variabile dal 3 al 10% secondo le esigenze legate ad ogni progetto - El porcentaje de tensión aplicado a la tela puede variar entre el 3 y el 10% según las especificaciones técnicas a cada proyecto.



Les toiles de la gamme Mirror®, peuvent présenter de petites marques liées au process de fabrication. Les perforations pour la version acoustique, peuvent être apparentes. - Small marks being a part of manufacturing process may be present in the Mirror® range. The perforations for the acoustics version can be visible. - Kleine Markierungen, die Teil des Herstellungsprozesses sind, können in der Mirror®-Linie auftreten. Die Perforationen der Akustikversion können sichtbar sein. - I teli della gamma Mirror®, possono presentare dei piccoli segni legati ai processi di produzione. Le perforazioni per la versione acustica, possono essere visibili. - En las telas de la gama Mirror® pueden aparecer ligeras marcas debido al proceso de fabricación. Las perforaciones para la versión acustica pueden ser visibles.

Avertissement : L'utilisation de photos autres que celles proposées par Barrisol, issues d'Internet ou de supports papier est soumise à crédits pour leurs auteurs. Pour pouvoir soumettre un visuel pour impression, il faut par avance avoir obtenu l'autorisation de son auteur pour l'utiliser ou en avoir acquis les droits de reproduction. Barrisol décline toute responsabilité en cas de manquement à cette procédure. - Original material : Barrisol requires that artistic and photo credits be given to the creator of any original image. In order to submit an original image for printing, the permission of the artist or the reproduction rights for the image must first be obtained by its creator or current image licensee. Barrisol is not responsible for images printed without proper permission. - Original Druckvorlagen : Barrisol setzt voraus, dass Gestaltungs- und Bildrechte gegenüber dem Urheber einer Druckvorlage gewahrt sind. Für die Einreichung einer Druckvorlage muss die Genehmigung des Künstlers oder des Abdruckrechts für das Motiv vom Urheber oder aktuellen Lizenzinhaber eingeholt werden. Barrisol übernimmt keine Verantwortung für ohne Genehmigung ge-druckte Motive. Avertimento: L'utilizzazione di altre foto da quelle proposte da Barrisol, sul sito Internet o sui supporti cartacei sono sottoposti a crediti dai loro autori. Per potere sottoporre un'immagine per la stampa, occorre ottenere l'autorizzazione del suo autore per la sua utilizzazione o aver acquistato i diritti di riproduzione. Barrisol declina ogni responsabilità in caso di trasgressione a questa procedura. - Advertencia: La utilización de fotografías distintas de las propuestas por Barrisol, obtenidas por Internet o soportes papel se someten a créditos para sus autores. Para poder imprimir un visual, es necesario tener la autorización de su autor para utilizarlo o haber adquirido los derechos de reproducción. Barrisol declina toda responsabilidad en caso de no cumplir con este procedimiento



# Les Effets Matière® Material effects Material Effekte



Design : Barrisol®



Design : Barrisol®

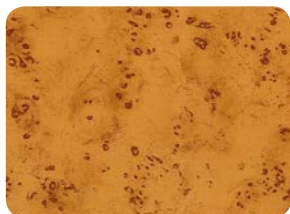

**BEM 01** Ronce de Noyer\*



**BEM 03** Cuir Havane\*



**BEM 14** Bambou Tibet\*

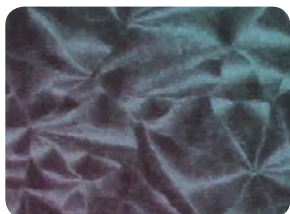

**BEM 04** Métal Iridescent\*

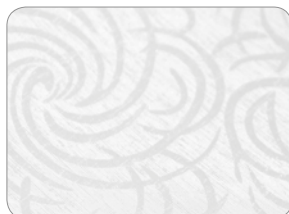

**BEM 13** Fleur White\*



**BEM 15** Bambou Blanc\*



**BEM 10** Fleurs noires\*

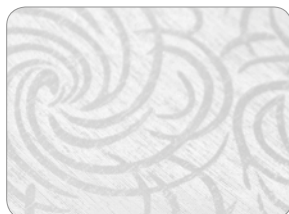

**BEM 11** Fleurs blanches\*

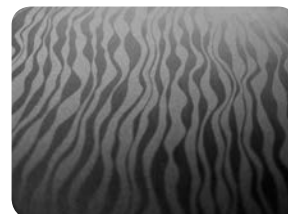

**BEM 12** Impulsions\*

## Collection Or - Gold collection - Kollektion Gold - Collezione oro - Colección Oro



**BEM 07** Or Iridescent\*



**BEM 08** Feuille d'Or\*



**BEM 09** Or brossé\*

*Images non contractuelles - non contractual pictures - Unverbindliche Bilder - Immagine non contrattuale - Imágenes no contractuales*

Pour mieux vous rendre compte des effets visuels des finitions de la gamme des Effets Matières®, nous vous conseillons de faire votre choix à partir d'échantillons format A4 minimum, disponibles sur simple demande.

To see the visual effects of the «Effets Matière®» line of products, we recommend you ask for larger samples of A4 size and above. These samples are available on request.

Um den visuellen Effekt der Folien «Effets matières®» wählen zu können, stellen wir Ihnen A4-Muster zur Verfügung. Gerne können wir Ihnen die gewünschten Muster auf Anfrage zukommen lassen.

Per rendervi conto al meglio degli effetti visuali delle finiture della gamma degli «Effets Matières®», vi consigliamo di fare la vostra scelta a partire di campioni formato A4 minimo, disponibili su semplice richiesta.

Les recomendamos basarse en nuestro formato A4 para poder visualizar mejor y validar los efectos de los acabados Efectos materias (Effets Matières®), disponibles bajo petición.

## ACOUSTICS®

A15 - A20 - A30 : ≤ 220 cm

A40 : ≤ 200 cm.

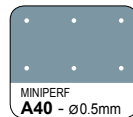
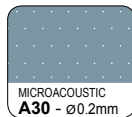
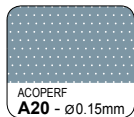
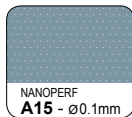

## PERFORATIONS - PERFORAZIONE - PERFORACIONEN - PERFORAZIONE - PERFORACIÓN

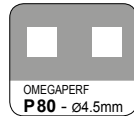
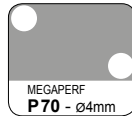
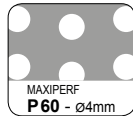
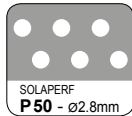
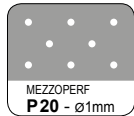
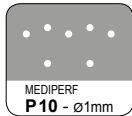

Classement au feu - Fire classification - Brandverhalten - Classe di reazione al fuoco - Clasificación al fuego

**B-s3, d0**

Largeur des lés - Sheet width - Folienbreite - Larghezza dei teli - Ancho de tela

A noter : des soudures sont possibles dans les plafonds en fonction des dimensions et configurations de projets - Please note : seams are possible on the ceilings depending on the projects dimensions and configuration. - Bemerkung: Nähte in der Spanndecke sind je nach Abmessungen und Projektkonfiguration möglich. - NB: Sarà possibile la presenza di saldature sui controsoffitti in base alla geometria e dimensioni dei teli e alle caratteristiche dei progetti. - A tener en cuenta : las soldaduras son posibles en función de las dimensiones o configuraciones de los proyectos.

**\*140 cm**  
 **135 cm**

Epaisseur - Thickness - Dicke - Spessore - Espesor

**20 - 30 / 100**



Certificat de conformitate CE  
 N° 0071 - CPR - 23811 rev. 1  
 DIMENSIONI DANS L'AIR INTERIEUR



 Le pourcentage de tension appliqué à la toile peut varier de 3 à 10% selon les contraintes liées à chaque projet - The percentage of tension applied to the sheet can vary from 3 to 10% depending on the constraints of each project - Die auf die Folie angebrachte Spannung kann von 3 bis 10% je nach den Projektbeschränkungen variieren - La percentuale di tensione applicata al telo può essere variabile dal 3 al 10% secondo le esigenze legate ad ogni progetto - El porcentaje de tensión aplicado a la tela puede variar entre el 3 y el 10% según las especificaciones técnicas a cada proyecto.

Les couleurs imprimées peuvent présenter un léger écart avec la réalité, notre carte d'échantillons est à votre disposition pour plus de précisions. - Printed colors may present a slight variation with the reality, our sample booklet is available for more precision. - Die gedruckten Farben können in der Realität von der Darstellung abweichen; eine Broschüre mit Muster ist für genauere Abgleiche erhältlich - I colori riportati nella presente stampa possono presentare una leggera differenza dal materiale reale, la nostra campionatura è a vostra disposizione per facilitare la vostra scelta. - Dado que estos colores fueron impresos puede existir una diferencia con la realidad, por eso nuestra carta con muestras está a su disposición para una mayor precisión.

En fonction de l'intensité de l'exposition au rayonnement solaire, de la composition de l'atmosphère de la pièce (fumée...), la teinte peut légèrement varier dans le temps. Depending on the intensity of the solar radiance exposition and the atmosphere composition (smoke...) of the room, the shade of the sheet may vary in the time. Abhängig von der Sonneneinstrahlung und der Luftzusammensetzung im Raum (Rauch...) kann sich das Erscheinungsbild der Folien zeitlich ändern. In funzione dell'intensità dell'esposizione ai raggi del sole e della composizione dell'atmosfera (fumo...) della stanza, la tinta del telo può leggermente variare col tempo. Según la intensidad de la exposición a la radiación solar, de la composición de la atmósfera de la habitación (humo...), el tinte puede variar con el tiempo.

# Les Effets Béton® Concrete effect Beton Effekt

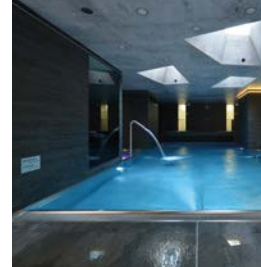

Arch. : Karel Mrázek



Design : Barrisol®



**BEB01**



**BEB02**



**BEB03**



**BEB04**



**BEB05**



**BEB06**



**BEB07**



**BEB08**



**BEB09**

*Images non contractuelles - non contractual pictures - Unverbindliche Bilder - Immagine non contrattuale - Imágenes no contractuales*



# Imprimez votre visuel - Print your own images - Bedrucken Sie Ihre eigenen Bilder Stampare le Vs immagini - Imprimir sus imágenes

Toile imprimée - Printed sheet  
Bedruckte Folie - Telo stampato  
Tela impresa

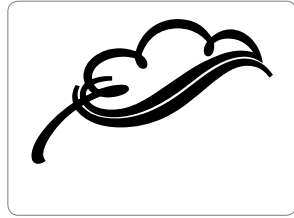

Elements à fournir - Eléments to provide for printing - Benötigte Daten für Ihre Bestellung - Elementi da fornire  
Elementos que proporcionar

Positionnement de l'image - Image position  
Bildpositionierung - Posizionamento dell'immagine  
Localización de la imagen

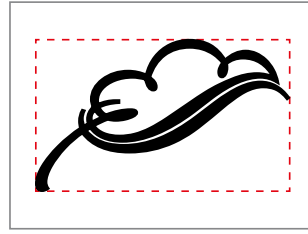
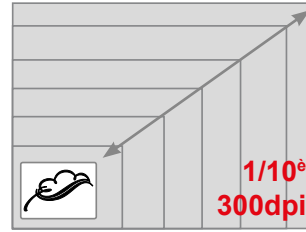

Image à fournir - Image to provide for printing  
Bild / Foto - Elementi da fornire - Imagen



Couleurs - Colours  
Farben - Colori - Colores  
**CMJN**

Fichier - File  
Datey - Archivio - Archivio  
**TIFF, EPS, JPG**

**ACOUSTICS®**

A15 - A20 - A30 : ≤ 220 cm

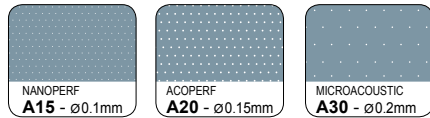

Etude de faisabilité et validation du motif par notre bureau d'études obligatoire, merci de nous contacter pour toute information complémentaire

Acceptance and validation by our technical office required, please contact us for more information

Freigabe und Bestätigung durch unser technisches Entwicklungsbüro, für weitere Fragen stehen wir Ihnen gerne zur Verfügung

Studio di fattibilità e convalida dell'immagine dal nostro ufficio tecnico obbligatoria, vi preghiamo di contattarci per ogni richiesta supplementare

Estudio de viabilidad y validación de la image por nuestra empresa es obligatorio, gracias por contactarnos para cualquier información complementaria

Classement au feu - Fire classification - Brandverhalten - Classe di reazione al fuoco - Clasificación al fuego

**B-s2, d0**

Largueur d'impression sans soudure - Printed width without seem - Druckgröße übergangslos

Misura della stampa senza saldatura - Ancho de impresión sin soldadura

A noter : des soudures sont possibles dans les plafonds en fonction des dimensions et configurations de projets - Please note : seams are possible on the ceilings depending on the projects dimensions and configuration. - Bemerkung: Nähte in der Spanndecke sind je nach Abmessungen und Projektkonfiguration möglich. - NB: Sarà possibile la presenza di saldature sui controsoffitti in base alla geometria e dimensioni di tali e alle caratteristiche dei progetti. - A tener en cuenta : las soldaduras son posibles en función de las dimensiones o configuraciones de los proyectos.

**248 cm**  
← 240 cm

Délais d'impression - Printing lead-time - Druckbearbeitungsdauer - Tempi di stampa

Plazos de impresión

**3 semaines\***  
weeks - Wochen - semanas - semanas



<sup>(1)</sup> Commande spéciale - Special order - Sonderbestellung - Ordine speciale - Pedido especial

\* Dès validation complète du dossier - From file acceptance and validation - Ab kompletter Bestätigung der Daten - A partire della validazione completa del disegno - A partir de validación completa del techo.

← Le pourcentage de tension appliqué à la toile peut varier de 3 à 10% selon les contraintes liées à chaque projet - The percentage of tension applied to the sheet can vary from 3 to 10% depending on the constraints of each project - Die auf die Folie angebrachte Spannung kann von 3 bis 10% je nach den Projektbeschränkungen variieren - La percentuale di tensione applicata al telo può essere variabile dal 3 al 10% secondo le esigenze legate ad ogni progetto - El porcentaje de tensión aplicado a la tela puede variar entre el 3 y el 10% según las especificaciones técnicas a cada proyecto.



En fonction de l'intensité de l'exposition au rayonnement solaire, de la composition de l'atmosphère de la pièce (fumée...), la teinte peut légèrement varier dans le temps. Depending on the intensity of the solar radiation exposition and the atmosphere composition (smoke...) of the room, the shade of the sheet may vary in the time. Abhängig von der Sonneninstrahlung und der Luftzusammensetzung im Raum (Rauch...) kann sich das Erscheinungsbild der Folien zeitlich ändern. In funzione dell'intensità dell'esposizione ai raggi del sole e della composizione dell'atmosfera (fumo...) della stanza, la tinta del telo può leggermente variare col tempo. Según la intensidad de la exposición a la radiación solar, de la composición de la habitación (humo...), el tinte puede variar con el tiempo.

**Avvertimento:** L'utilizzazione di fotos autres que celles proposées par Barrisol, issues d'Internet ou de supports papier est soumise à crédits pour leurs auteurs. Pour pouvoir soumettre un visuel pour impression, il faut par avance avoir obtenu l'autorisation de son auteur pour l'utiliser ou en avoir acquis les droits de reproduction. Barrisol décline toute responsabilité en cas de manquement à cette procédure. - Original material : Barrisol requires that artistic and photo credits be given to the creator of any original image. In order to submit an original image for printing, the permission of the artist or the reproduction rights for the image must first be obtained by its creator or current image licensee. Barrisol is not responsible for images printed without proper permission. - Original Druckvorlagen : Barrisol setzt voraus, dass Gestaltungs- und Bildrechte gegenüber dem Urheber einer Druckvorlage gewahrt sind. Für die Einreichung einer Druckvorlage muss die Genehmigung des Künstlers oder das Abdrucksrecht für das Motiv vom Urheber oder aktuellen Lizenzinhaber eingeholt werden. Barrisol übernimmt keine Verantwortung für ohne Genehmigung ge-druckte Motive. Avvertimento: L'utilizzazione di altre foto da quelle proposte da Barrisol, sul sito Internet o sui supporti cartacei sono sottoposti a crediti dai loro autori. Per potere sottoporre un'immagine per la stampa, occorre ottenere l'autorizzazione del suo autore per la sua utilizzazione o aver acquistato i diritti di riproduzione. Barrisol declina ogni responsabilità in caso di trasgressione a questa procedura. - Advertencia: La utilización de fotografías distintas de las propuestas por Barrisol, obtenidas por Internet o soportes papel se someten a créditos para sus autores. Para poder imprimir un visual, es necesario tener la autorización de su autor para utilizarlo o haber adquirido los derechos de reproducción. Barrisol declina toda responsabilidad en caso de no cumplir con este procedimiento

# Les Effets Bois® Wood effect Holz Effekt



Design : Barrisol®



Design : Barrisol®



**BEW01**



**BEW02**

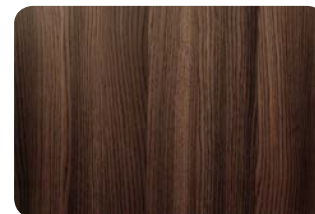

**BEW03**



**BEW04**



**BEW05**



**BEW06**



**BEW07**



**BEW08**



**BEW09**



**BEW10**

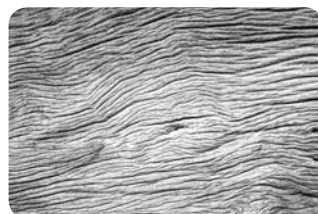

**BEW11**

*Images non contractuelles - non contractual pictures - Unverbindliche Bilder - Immagine non contrattuali - Imágenes no contractuales*

# Imprimez votre visuel - Print your own images - Bedrucken Sie Ihre eigenen Bilder Stampare le Vs immagini - Imprimir sus imágenes

Toile imprimée - Printed sheet  
Bedrúkte folie - Telo stampato  
Tela impresa

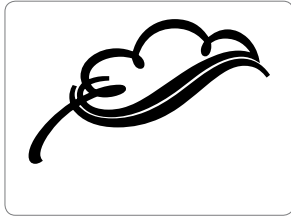

Elements à fournir - Eléments to provide for printing - Benötigte Daten für Ihre Bestellung - Elementi da fornire  
Elementos que proporcionar

Positionnement de l'image - Image position  
Bildpositionierung - Posizionamento dell'immagine  
Localización de la imagen

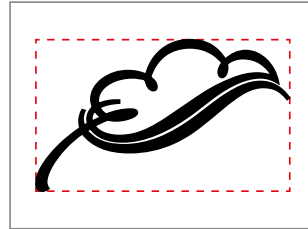
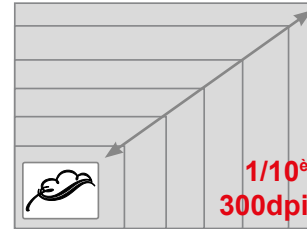

Image à fournir - Image to provide for printing  
Bild / Foto - Elementi da fornire - Imagen



Couleurs - Colours  
Farben - Colori - Colores  
**CMJN**

Fichier - File  
Datey - Archivio - Archivo  
**TIFF, EPS, JPG**

**ACOUSTICS®**

A15 - A20 - A30 : ≤ 220 cm

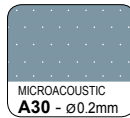
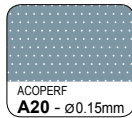
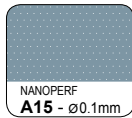

Etude de faisabilité et validation du motif par notre bureau d'études obligatoire, merci de nous contacter pour toute information complémentaire

Acceptance and validation by our technical office required, please contact us for more information

Freigabe und Bestätigung durch unser technisches Entwicklungsbüro, für weitere Fragen stehen wir Ihnen gerne zur Verfügung

Studio di fattibilità e convalida dell'immagine dal nostro ufficio tecnico obbligatoria, vi preghiamo di contattarci per ogni richiesta supplementare

Estudio de viabilidad y validación de la image por nuestra empresa es obligatorio, gracias por contactarnos para cualquier información complementaria

Classement au feu - Fire classification - Brandverhalten - Classe di reazione al fuoco - Clasificación al fuego

**B-s2, d0**

Largueur d'impression sans soudure - Printed width without seem - Druckgröße übergangslos

Misura della stampa senza saldatura - Ancho de impresión sin soldadura

A noter : des soudures sont possibles dans les plafonds en fonction des dimensions et configurations de projets - Please note : seams are possible on the ceilings depending on the projects dimensions and configuration. - Bemerkung: Nähte in der Spanndecke sind je nach Abmessungen und Projektkonfiguration möglich. - NB: Sarà possibile la presenza di saldature sui controsoffitti in base alla geometria e dimensioni di teli e alle caratteristiche dei progetti. - A tener en cuenta : las soldaduras son posibles en función de las dimensiones o configuraciones de los proyectos.

**248 cm**  
← 240 cm

Délais d'impression - Printing lead-time - Druckbearbeitungsdauer - Tempi di stampa  
Plazos de impresión

**3 semaines\***  
weeks - Wochen - semanas - semanas



(\*) Commande spéciale - Special order - Sonderbestellung - Ordine speciale - Pedido especial

\* Dès validation complète du dossier - From file acceptance and validation - Ab kompletter Bestätigung der Daten - A partire della validazione completa del disegno - A partir de validación completa del telho.

← Le pourcentage de tension appliqué à la toile peut varier de 3 à 10% selon les contraintes liées à chaque projet - The percentage of tension applied to the sheet can vary from 3 to 10% depending on the constraints of each project. - Die auf die Folie angebrachte Spannung kann von 3 bis 10% je nach den Projektbeschränkungen variieren - La percentuale di tensione applicata al telo può essere variabile dal 3 al 10% secondo le esigenze legate ad ogni progetto - El porcentaje de tensión aplicado a la tela puede variar entre el 3 y el 10% según las especificaciones técnicas a cada proyecto.



En fonction de l'intensité de l'exposition au rayonnement solaire, de la composition de l'atmosphère de la pièce (fumée...), la teinte peut légèrement varier dans le temps. Depending on the intensity of the solar radiation exposition and the atmosphere composition (smoke...) of the room, the shade of the sheet may vary in the time. Abhängig von der Sonneneinstrahlung und der Luftzusammensetzung im Raum (Rauch...) kann sich das Erscheinungsbild der Folien zeitlich ändern. In funzione dell'intensità dell'esposizione ai raggi del sole e della composizione dell'atmosfera (fumo...) della stanza, la tinta del telo può leggermente variare col tempo. Según la intensidad de la exposición a la radiación solar, de la composición de la atmósfera de la habitación (humo...), el tinte puede variar con el tiempo.

**Avvertimento:** L'utilizzazione di fotos autres que celles proposées par Barrisol, issues d'Internet ou de supports papier est soumise à crédits pour leurs auteurs. Pour pouvoir soumettre un visuel pour impression, il faut par avance avoir obtenu l'autorisation de son auteur pour l'utiliser ou en avoir acquis les droits de reproduction. Barrisol décline toute responsabilité en cas de manquement à cette procédure. - Original material : Barrisol requires that artistic and photo credits be given to the creator of any original image. In order to submit an original image for printing, the permission of the artist or the reproduction rights for the image must first be obtained by its creator or current image licensee. Barrisol is not responsible for images printed without proper permission. - Original Druckvorlagen : Barrisol setzt voraus, dass Gestaltungs- und Bildrechte gegenüber dem Urheber einer Druckvorlage gewährt sind. Für die Einreichung einer Druckvorlage muss die Genehmigung des Künstlers oder das Abdrucksrecht für das Motiv vom Urheber oder aktuellen Lizenzinhaber eingeholt werden. Barrisol übernimmt keine Verantwortung für ohne Genehmigung ge-druckte Motive. - Advertencia: La utilización de fotografías distintas de las propuestas por Barrisol, obtenidas por Internet o soportes papel se someten a créditos para sus autores. Para poder imprimir un visual, es necesario tener la autorización de su autor para utilizarlo o haber adquirido los derechos de reproducción. Barrisol declina toda responsabilidad en caso de no cumplir con este procedimiento



# Les Effets Brique® Brick effect Backstein Effekt

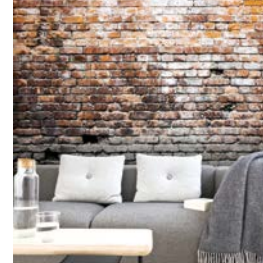

Design : Barrisol®



Design : Barrisol®

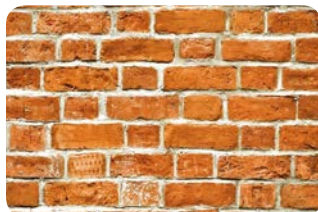

**BEK01**



**BEK02**



**BEK03**



**BEK04**



**BEK05**

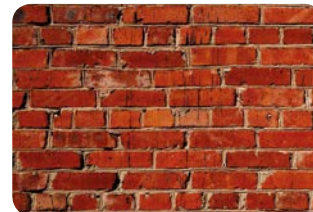

**BEK06**



**BEK07**



**BEK08**



**BEK09**



**BEK10**



**BEK11**



**BEK12**

*Images non contractuelles - non contractual pictures - Unverbindliche Bilder - Immagine non contrattuale - Imágenes no contractuales*

## Imprimez votre visuel - Print your own images - Bedrucken Sie Ihre eigenen Bilder Stampare le Vs immagini - Imprimir sus imágenes

Toile imprimée - Printed sheet  
Bedrúckte Folie - Telo stampato  
Tela impresa

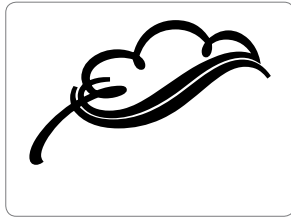

Elements à fournir - Eléments to provide for printing - Benötigte Daten für Ihre Bestellung - Elementi da fornire  
Elementos que proporcionar

Positionnement de l'image - Image position  
Bildpositionierung - Posizionamento dell'immagine  
Localización de la imagen

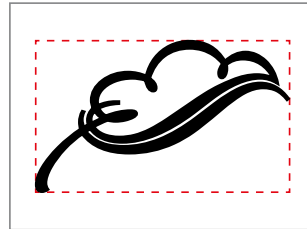
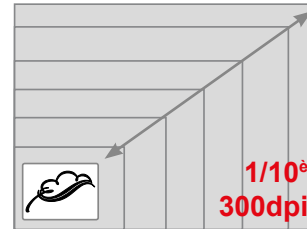

Image à fournir - Image to provide for printing  
Bild / Foto - Elementi da fornire - Imagen



Couleurs - Colours  
Farben - Colori - Colores  
**CMJN**

Fichier - File  
Datey - Archivio - Archivio  
**TIFF, EPS, JPG**

**ACOUSTICS®** A15 - A20 - A30 : ≤ 220 cm

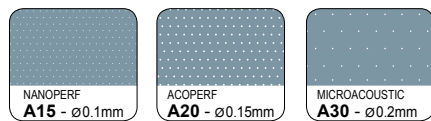

Etude de faisabilité et validation du motif par notre bureau d'études obligatoire, merci de nous contacter pour toute information complémentaire

Acceptance and validation by our technical office required, please contact us for more information

Freigabe und Bestätigung durch unser technisches Entwicklungsbüro, für weitere Fragen stehen wir Ihnen gerne zur Verfügung

Studio di fattibilità e convalida dell'immagine dal nostro ufficio tecnico obbligatoria, vi preghiamo di contattarci per ogni richiesta supplementare

Estudio de viabilidad y validación de la image por nuestra empresa es obligatorio, gracias por contactarnos para cualquier información complementaria

Classement au feu - Fire classification - Brandverhalten - Classe di reazione al fuoco - Clasificación al fuego

**B-s2, d0**

Largueur d'impression sans soudure - Printed width without seem - Druckgröße übergangslos

Misura della stampa senza saldatura - Ancho de impresión sin soldadura

A noter : des soudures sont possibles dans les plafonds en fonction des dimensions et configurations de projets - Please note : seams are possible on the ceilings depending on the projects dimensions and configuration. - Bemerkung: Nähte in der Spanndecke sind je nach Abmessungen und Projektkonfiguration möglich. - NB: Sarà possibile la presenza di saldature sui controsoffitti in base alla geometria e dimensioni di tali e alle caratteristiche dei progetti. - A tener en cuenta : las soldaduras son posibles en función de las dimensiones o configuraciones de los proyectos.

**248 cm**  
← → 240 cm

Délais d'impression - Printing lead-time - Druckbearbeitungsdauer - Tempi di stampa  
Plazos de impresión

**3 semaines\***  
weeks - Wochen - semanas - semanas



(\*) Commande spéciale - Special order - Sonderbestellung - Ordine speciale - Pedido especial

\* Dès validation complète du dossier - From file acceptance and validation - Ab kompletter Bestätigung der Daten - A partire della validazione completa del disegno - A partir de validación completa del teho.

← → Le pourcentage de tension appliqué à la toile peut varier de 3 à 10% selon les contraintes liées à chaque projet - The percentage of tension applied to the sheet can vary from 3 to 10% depending on the constraints of each project. - Die auf die Folie angebrachte Spannung kann von 3 bis 10% je nach den Projektbeschränkungen variieren - La percentuale di tensione applicata al telo può essere variabile dal 3 al 10% secondo le esigenze legate ad ogni progetto - El porcentaje de tensión aplicado a la tela puede variar entre el 3 y el 10% según las especificaciones técnicas a cada proyecto.



En fonction de l'intensité de l'exposition au rayonnement solaire, de la composition de l'atmosphère de la pièce (fumée...), la teinte peut légèrement varier dans le temps. Depending on the intensity of the solar radiation exposition and the atmosphere composition (smoke...) of the room, the shade of the sheet may vary in the time. Abhängig von der Sonnenstrahlung und der Luftzusammensetzung im Raum (Rauch...) kann sich das Erscheinungsbild der Folien zeitlich ändern. In funzione dell'intensità dell'esposizione ai raggi del sole e della composizione dell'atmosfera (fumo...) della stanza, la tinta del telo può leggermente variare col tempo. Según la intensidad de la radiación solar, de la composición de la atmósfera de la habitación (humo...), el tinte puede variar con el tiempo.

**Avvertimento:** L'utilizzazione di fotos autres que celles proposées par Barrisol, issues d'Internet ou de supports papier est soumise à crédits pour leurs auteurs. Pour pouvoir soumettre un visuel pour impression, il faut par avance avoir obtenu l'autorisation de son auteur pour l'utiliser ou en avoir acquis les droits de reproduction. Barrisol décline toute responsabilité en cas de manquement à cette procédure. - Original material : Barrisol requires that artistic and photo credits be given to the creator of any original image. In order to submit an original image for printing, the permission of the artist or the reproduction rights for the image must first be obtained by its creator or current image licensee. Barrisol is not responsible for images printed without proper permission. - Original Druckvorlagen : Barrisol setzt voraus, dass Gestaltungs- und Bildrechte gegenüber dem Urheber einer Druckvorlage gewahrt sind. Für die Einreichung einer Druckvorlage muss die Genehmigung des Künstlers oder das Abdrucksrecht für das Motiv vom Urheber oder aktuellen Lizenzinhaber eingeholt werden. Barrisol übernimmt keine Verantwortung für ohne Genehmigung ge-druckte Motive. Avvertimento: L'utilizzazione di altre foto da quelle proposte da Barrisol, sul sito Internet o sui supporti cartacei sono sottoposti a crediti dai loro autori. Per potere sottoporre un'immagine per la stampa, occorre ottenere l'autorizzazione del suo autore per la sua utilizzazione o aver acquistato i diritti di riproduzione. Barrisol declina ogni responsabilità in caso di trasgressione a questa procedura. - Advertencia: La utilización de fotografías distintas de las propuestas por Barrisol, obtenidas por Internet o soportes papel se someten a créditos para sus autores. Para poder imprimir un visual, es necesario tener la autorización de su autor para utilizarlo o haber adquirido los derechos de reproducción. Barrisol declina toda responsabilidad en caso de no cumplir con este procedimiento

# Les Effets Marbre®

Marble effect  
Marmor Effekt



Arch. : M-OFIS Architecture



Design : Barrisol®

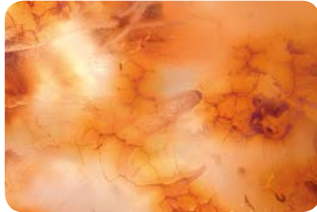

**BER01**



**BER02**

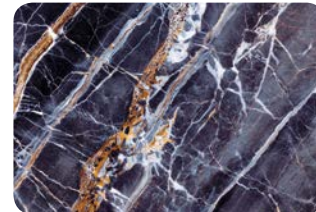

**BER03**



**BER04**



**BER05**



**BER06**



**BER07**



**BER08**



**BER09**



**BER10**

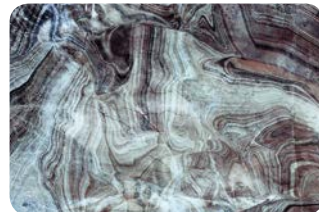

**BER11**

*Images non contractuelles - non contractual pictures - Unverbindliche Bilder - Immagine non contrattuale - Imágenes no contractuales*



## Imprimez votre visuel - Print your own images - Bedrucken Sie Ihre eigenen Bilder Stampare le Vs immagini - Imprimir sus imágenes

Toile imprimée - Printed sheet  
Bedruckte Folie - Telo stampato  
Tela impresa

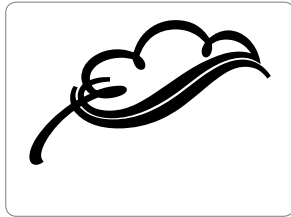

Elements à fournir - Eléments to provide for printing - Benötigte Daten für Ihre Bestellung - Elementi da fornire  
Elementos que proporcionar

Positionnement de l'image - Image position  
Bildpositionierung - Posizionamento dell'immagine  
Localización de la imagen

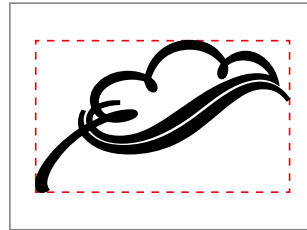
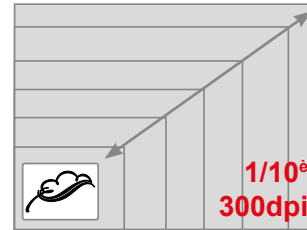

Image à fournir - Image to provide for printing  
Bild / Foto - Elementi da fornire - Imagen



Couleurs - Colours  
Farben - Colori - Colores  
**CMJN**

Fichier - File  
Datey - Archivio - Archivo  
**TIFF, EPS, JPG**

**ACOUSTICS®** A15 - A20 - A30 : ≤ 220 cm

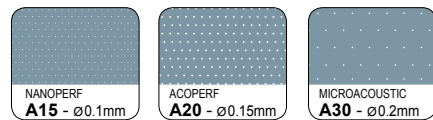

Etude de faisabilité et validation du motif par notre bureau d'études obligatoire, merci de nous contacter pour toute information complémentaire

Acceptance and validation by our technical office required, please contact us for more information

Freigabe und Bestätigung durch unser technisches Entwicklungsbüro, für weitere Fragen stehen wir Ihnen gerne zur Verfügung

Studio di fattibilità e convalida dell'immagine dal nostro ufficio tecnico obbligatoria, vi preghiamo di contattarci per ogni richiesta supplementare

Estudio de viabilidad y validación de la image por nuestra empresa es obligatorio, gracias por contactarnos para cualquier información complementaria

Classement au feu - Fire classification - Brandverhalten - Classe di reazione al fuoco - Clasificación al fuego

**B-s2, d0**

Largueur d'impression sans soudure - Printed width without seem - Druckgröße übergangslos

Misura della stampa senza saldatura - Ancho de impresión sin soldadura

A noter : des soudures sont possibles dans les plafonds en fonction des dimensions et configurations de projets - Please note : seams are possible on the ceilings depending on the projects dimensions and configuration. - Bemerkung: Nähte in der Spanndecke sind je nach Abmessungen und Projektkonfiguration möglich. - NB: Sarà possibile la presenza di saldature sui controsoffitti in base alla geometria e dimensioni di teli e alle caratteristiche dei progetti. - A tener en cuenta : las soldaduras son posibles en función de las dimensiones o configuraciones de los proyectos.

**248 cm**  
← 240 cm

Délais d'impression - Printing lead-time - Druckbearbeitungsdauer - Tempi di stampa  
Plazos de impresión

**3 semaines\***  
weeks - Wochen - semanas - semanas



<sup>(1)</sup> Commande spéciale - Special order - Sonderbestellung - Ordine speciale - Pedido especial

\* Dès validation complète du dossier - From file acceptance and validation - Ab kompletter Bestätigung der Daten - A partire della validazione completa del disegno - A partir de validación completa del telho.

← Le pourcentage de tension appliqué à la toile peut varier de 3 à 10% selon les contraintes liées à chaque projet - The percentage of tension applied to the sheet can vary from 3 to 10% depending on the constraints of each project. - Die auf die Folie angebrachte Spannung kann von 3 bis 10% je nach den Projektbeschränkungen variieren - La percentuale di tensione applicata al telo può essere variabile dal 3 al 10% secondo le esigenze legate ad ogni progetto - El porcentaje de tensión aplicado a la tela puede variar entre el 3 y el 10% según las especificaciones técnicas a cada proyecto.



En fonction de l'intensité de l'exposition au rayonnement solaire, de la composition de l'atmosphère de la pièce (fumée...), la teinte peut légèrement varier dans le temps. Depending on the intensity of the solar radiation exposition and the atmosphere composition (smoke...) of the room, the shade of the sheet may vary in the time. Abhängig von der Sonnenstrahlung und der Luftzusammensetzung im Raum (Rauch...) kann sich das Erscheinungsbild der Folien zeitlich ändern. In funzione dell'intensità dell'esposizione ai raggi del sole e della composizione dell'atmosfera (fumo...) della stanza, la tinta del telo può leggermente variare col tempo. Según la intensidad de la radiación solar, de la composición de la atmósfera de la habitación (humo...), el tinte puede variar con el tiempo.

**Avvertimento:** L'utilizzazione di fotos autres que celles proposées par Barrisol, issues d'Internet ou de supports papier est soumise à crédits pour leurs auteurs. Pour pouvoir soumettre un visuel pour impression, il faut par avance avoir obtenu l'autorisation de son auteur pour l'utiliser ou en avoir acquis les droits de reproduction. Barrisol décline toute responsabilité en cas de manquement à cette procédure. - Original material : Barrisol requires that artistic and photo credits be given to the creator of any original image. In order to submit an original image for printing, the permission of the artist or the reproduction rights for the image must first be obtained by its creator or current image licensee. Barrisol is not responsible for images printed without proper permission. - Original Druckvorlagen : Barrisol setzt voraus, dass Gestaltungs- und Bildrechte gegenüber dem Urheber einer Druckvorlage gewahrt sind. Für die Einreichung einer Druckvorlage muss die Genehmigung des Künstlers oder das Abdrucksrecht für das Motiv vom Urheber oder aktuellen Lizenzinhaber eingeholt werden. Barrisol übernimmt keine Verantwortung für ohne Genehmigung ge-druckte Motive. Avvertimento: L'utilizzazione di altre foto da quelle proposte da Barrisol, sul sito Internet o sui supporti cartacei sono sottoposti a crediti dai loro autori. Per potere sottoporre un'immagine per la stampa, occorre ottenere l'autorizzazione del suo autore per la sua utilizzazione o aver acquistato i diritti di riproduzione. Barrisol declina ogni responsabilità in caso di trasgressione a questa procedura. - Advertencia: La utilización de fotografías distintas de las propuestas por Barrisol, obtenidas por Internet o soportes papel se someten a créditos para sus autores. Para poder imprimir un visual, es necesario tener la autorización de su autor para utilizarlo o haber adquirido los derechos de reproducción. Barrisol declina toda responsabilidad en caso de no cumplir con este procedimiento

# Print your mind®



Design : Simon Norris



Arch. : Milewski Piotr

## Portfolio - Portfolio - Fotokatalog - Collezione d'immagini - Fototeca



Musée d'Impression sur Étoffes



Art de la table - Food and beverage  
Essen und trinken - Arti del tavolo  
Artes de la mesa



Faune - Animals - Tieren - Fauna - Fauna



Eau - Water - Wasser - Aqua - Agua



Roses - Roses - Rosen - Rose - Rosas



Divers - Various - Verschieden - Varie - Varios



Merveilles - Wonders of the world -  
Weltwunder - Meraviglie - Maravillas



Zen

Découvrez toutes les images de notre portfolio sur [www.barrisol.com](http://www.barrisol.com), ou dans notre brochure *Print your Mind*.  
Discover all the images available in our collection on our website [www.barrisol.com](http://www.barrisol.com), or in our *Print Your Mind* documentation  
Alle Fotos finden Sie auf der Webseite [www.barrisol.com](http://www.barrisol.com), oder in unserer Broschüre *Print your Mind*  
Scoprite tutte le immagini del nostro portfolio su [www.barrisol.com](http://www.barrisol.com), o nella nostra brochure *Print your Mind*.  
Descubra todas las imágenes de nuestra fototeca en [www.barrisol.com](http://www.barrisol.com), o en nuestro folleto *Print your Mind*.

# Imprimez vos images - Print your own images - Bedrucken Sie Ihre eigenen Bilder Stampare le Vs immagini - Imprimir sus imágenes

Toile imprimée - Printed sheet  
Bedrúckte Folie - Telo stampato  
Tela impresa

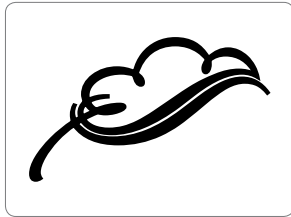

Elements à fournir - Eléments to provide for printing - Benötigte Daten für Ihre Bestellung - Elementi da fornire  
Elementos que proporcionar

Positionnement de l'image - Image position  
Bildpositionierung - Posizionamento dell'immagine  
Localización de la imagen

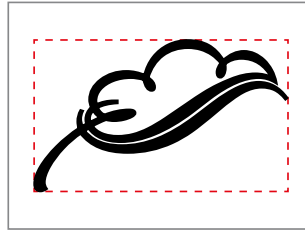
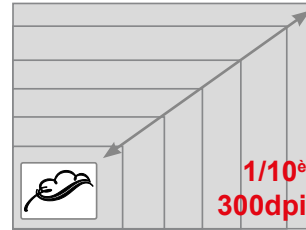

Image à fournir - Image to provide for printing  
Bild / Foto - Elementi da fornire - Imagen



Couleurs - Colours  
Farben - Colori - Cores  
**CMJN**

Fichier - File  
Datey - Archivio - Archivo  
**TIFF, EPS, JPG**

## ACOUSTICS®

A15 - A20 - A30 : ≤ 220 cm

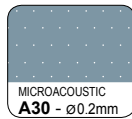
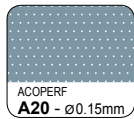
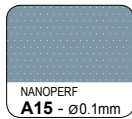

A40 : ≤ 200 cm.

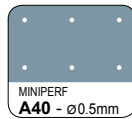

## PERFORATIONS - PERFORATIONS - PERFORATIONEN - PERFORAZIONE - PERFORACIÓN

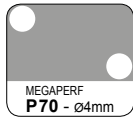
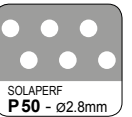
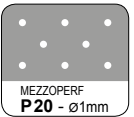
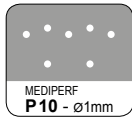

Etude de faisabilité et validation du motif par notre bureau d'études obligatoire, merci de nous contacter pour toute information complémentaire

Acceptance and validation by our technical office required, please contact us for more information

Freigabe und Bestätigung durch unser technisches Entwicklungsbüro, für weitere Fragen stehen wir Ihnen gerne zur Verfügung

Studio di fattibilità e convalida dell'immagine dal nostro ufficio tecnico obbligatoria, vi preghiamo di contattarci per ogni richiesta supplementare

Estudio de viabilidad y validación de la image por nuestra empresa es obligatorio, gracias por contactarnos para cualquier información complementaria

Classement au feu - Fire classification - Brandverhalten  
Classe di reazione al fuoco - Clasificación al fuego

**B-s2, d0**

Largueur d'impression sans soudure - Printed width without seam - Druckgröße übergangslos

Misura della stampa senza saldatura - Ancho de impresión sin soldadura

A noter : des soudures sont possibles dans les plafonds en fonction des dimensions et configurations de projets - Please note : seams are possible on the ceilings depending on the projects dimensions and configuration. - Bemerkung: Nähte in der Spanndecke sind je nach Abmessungen und Projektkonfiguration möglich. - NB: Sarà possibile la presenza di saldature sui controsoffitti in base alla geometria e dimensioni dei teli e alle caratteristiche dei progetti. - A tener en cuenta : las soldaduras son posibles en función de las dimensiones o configuraciones de los proyectos.

156 cm  
150 cm

206 cm  
200 cm

248 cm<sup>(1)</sup>  
240 cm

Délais d'impression - Printing lead-time - Druckbearbeitungsdauer - Tempi di stampa  
Plazos de impresión

**3 semaines\***  
weeks - Wochen - setimanas - semanas



<sup>(1)</sup> Commande spéciale - Special order - Sonderbestellung - Ordine speciale - Pedido especial

\* Dès validation complète du dossier - From file acceptance and validation - Ab kompletter Bestätigung der Daten - A partire della validazione completa del disegno - A partir de validación completa del techo.

Le pourcentage de tension appliqué à la toile peut varier de 3 à 10% selon les contraintes liées à chaque projet - The percentage of tension applied to the sheet can vary from 3 to 10% depending on the constraints of each project - Die auf die Folie angebrachte Spannung kann von 3 bis 10% je nach den Projektbeschränkungen variieren - La percentuale di tensione applicata al telo può essere variabile dal 3 al 10% secondo le esigenze legate ad ogni progetto - El porcentaje de tensión aplicado a la tela puede variar entre el 3 y el 10% según las especificaciones técnicas a cada proyecto.



En fonction de l'intensité de l'exposition au rayonnement solaire, de la composition de l'atmosphère de la pièce (fumée...), la teinte peut légèrement varier dans le temps. Depending on the intensity of the solar radiation exposition and the atmosphere composition (smoke...) of the room, the shade of the sheet may vary in the time. Abhängig von der Sonneneinstrahlung und der Luftzusammensetzung im Raum (Rauch...) kann sich das Erscheinungsbild der Folien zeitlich ändern. In funzione dell'intensità dell'esposizione ai raggi del sole e della composizione dell'atmosfera (fumo...) della stanza, la tinta del telo può leggermente variare col tempo. Según la intensidad de la exposición a la radiación solar, de la composición de la atmósfera de la habitación (humo...), el tinte puede variar con el tiempo.

**Avvertimento:** L'utilizzazione di fotos autres que celles proposées par Barrisol, issues d'Internet ou de supports papier est soumise à crédits pour leurs auteurs. Pour pouvoir soumettre un visuel pour impression, il faut par avance avoir obtenu l'autorisation de son auteur pour l'utiliser ou en avoir acquis les droits de reproduction. Barrisol décline toute responsabilité en cas de manquement à cette procédure. - Original material: Barrisol requires that artistic and photo credits be given to the creator of any original image. In order to submit an original image for printing, the permission of the artist or the reproduction rights for the image must first be obtained by its creator or current image licensee. Barrisol is not responsible for images printed without proper permission. - Original Druckvorlagen: Barrisol setzt voraus, dass Gestaltungs- und Bildrechte gegenüber dem Urheber einer Druckvorlage gewahrt sind. Für die Einreichung einer Druckvorlage muss die Genehmigung des Künstlers oder das Abdruckrecht für das Motiv vom Urheber oder aktuellen Lizenzinhaber eingeholt werden. Barrisol übernimmt keine Verantwortung für ohne Genehmigung ge-druckte Motive. - Advertencia: La utilización de fotografías distintas de las propuestas por Barrisol, obtenidas por Internet o soportes papel se someten a créditos para sus autores. Para poder imprimir un visual, es necesario tener la autorización de su autor para utilizarlo o haber adquirido los derechos de reproducción. Barrisol declina toda responsabilidad en caso de no cumplir con este procedimiento



# Perfodesign®



Design : Barrisol®

Arch. : PFZ Arquitectos

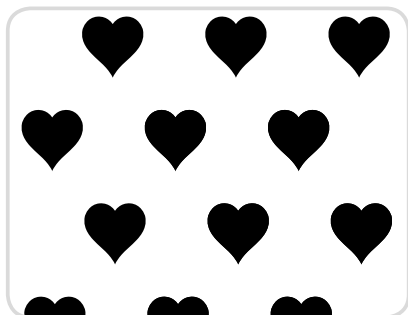

**BSP A** cœurs

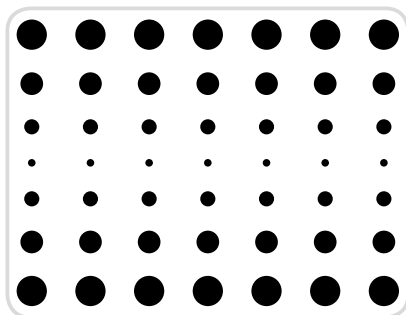

**BSP B** ronds

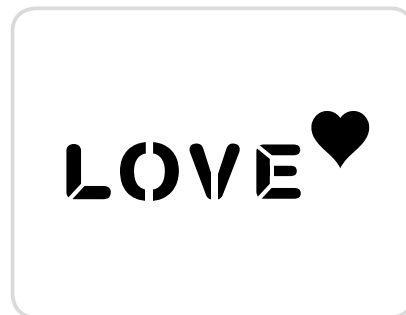

**BSP C** love



**BSP E** love Paris

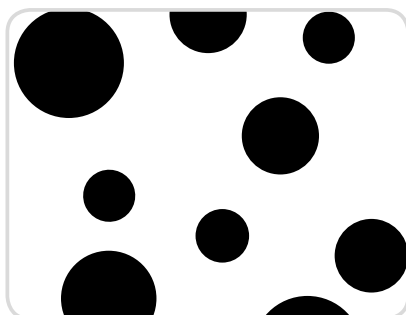

**BSP P** cercles aléatoires

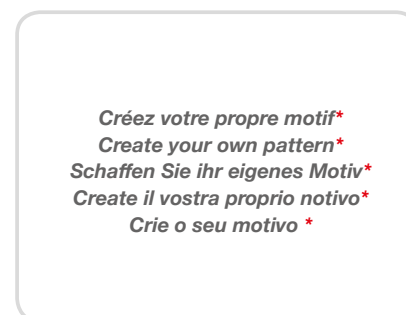

# Créez votre perforation - Create your own perforation

## Kreieren Sie Ihre eigene Perforierung - Create la vostra perforazione

### Crear su perforación

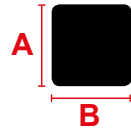

**A : min. 0.3 mm  
max. 100 mm**

**B : min. 0.3 mm  
max. 100 mm**



**Ø : min. 0.3 mm  
max. 100 mm**

**Taux d'ouverture maximum recommandé - Maximum recommended open area**  
**Maximale Folieöffnungsgrad empfohlen - Tasso d'apertura del telo massimo consigliato**  
**Tasa de apertura de la tela máxima aconsejada**

**30%**



**Etude de faisabilité et validation du motif par notre bureau d'études obligatoire, merci de nous contacter pour toute information complémentaire.**

**Acceptance and validation by our technical office required, please contact us for more information.**

**Freigabe und Bestätigung durch unser technisches Entwicklungsbüro. Für weitere Fragen stehen wir Ihnen gerne zur Verfügung.**

**Studio di fattibilità e convalida dell'immagine dal nostro ufficio tecnico obbligatoria, vi preghiamo di contattarci per ogni richiesta supplementare.**

**Estudio de viabilidad y validación del motivo por nuestra empresa es obligatorio, gracias por contactarnos para cualquier información complementaria.**

Classement au feu - Fire classification - Brandverhalten  
 Classe di reazione al fuoco - Clasificación al fuego

*Se référer au classement de la toile utilisée  
 Please refer to the chosen sheet classification  
 Bitte beziehen Sie sich auf das Brandverhalten der benutzten Folie  
 Riferirsi alla certificazione di reazione al fuoco del telo utilizzato  
 Gracias por consultar la clasificación al fuego de la tela utilizada*

Largeur de perforation - perforated width - Perforierungsgröße  
 Misura della perforazione - Ancho de perforación

A noter : des soudures sont possibles dans les plafonds en fonction des dimensions et configurations de projets - Please note : seams are possible on the ceilings depending on the projects dimensions and configuration. - Bemerkung: Nähte in der Spanndecke sind je nach Abmessungen und Projektkonfiguration möglich. - NB: Sarà possibile la presenza di saldature sui controsoffitti in base alla geometria e dimensioni dei teli e alle caratteristiche dei progetti. - A tener en cuenta : las soldaduras son posibles en función de las dimensiones o configuraciones de los proyectos.

**156 cm**  
 ◀ ▶ 150 cm

**206 cm**  
 ◀ ▶ 200 cm

**248 cm**  
 ◀ ▶ 240 cm

Délais de perforation - perforation lead-time - Perforierungsfrist  
 Tempi di perforazione - Plazos de perforación

**6 semaines\***  
 weeks - Wochen - settimane - semanas



\* Dès validation complète du dossier - From file acceptance and validation - Ab kompletter Bestätigung der Daten - A partire della validazione completa del disegno - A partir de validación completa del techo.

◀ ▶ Le pourcentage de tension appliqué à la toile peut varier de 3 à 10% selon les contraintes liées à chaque projet - The percentage of tension applied to the sheet can vary from 3 to 10% depending on the constraints of each project - Die auf die Folie angebrachte Spannung kann von 3 bis 10% je nach den Projektbeschränkungen variieren - La percentuale di tensione applicata al telo può essere variabile dal 3 al 10% secondo le esigenze legate ad ogni progetto - El porcentaje de tensión aplicado a la tela puede variar entre el 3 y el 10% según las especificaciones técnicas a cada proyecto.



En fonction de l'intensité de l'exposition au rayonnement solaire, de la composition de l'atmosphère de la pièce (fumée...), la teinte peut légèrement varier dans le temps. Depending on the intensity of the solar radiation exposure and the atmosphere composition (smoke...) of the room, the shade of the sheet may vary in the time. Abhängig von der Sonneneinstrahlung und der Luftzusammensetzung im Raum (Rauch...) kann sich das Erscheinungsbild der Folien zeitlich ändern. In funzione dell'intensità dell'esposizione ai raggi del sole e della composizione dell'atmosfera (fumo...) della stanza, la tinta del telo può leggermente variare col tempo. Según la intensidad de la exposición a la radiación solar, de la composición de la atmósfera de la habitación (humo...), el tinte puede variar con el tiempo.



Arch. : MHCS



Arch. : BDP London & CPU Retail Architects LDA



Arch. : Alia Alghunaim  
Design Manager : Mabanee Company S.A.K.



Arch. : Parallel Architecture

*50* ans  
years  
**BARRISOL**<sup>®</sup>  
1967 - 2017



Arch. : Foster + Partners



Arch. : Ingenhoven architects gmbh



Arch. : PHD Concept



Arch. : SUD Architects

52 ans de succès et d'innovation  
52 years of success and innovation  
52 Jahre Erfolg und Innovation





